



Sistemas de conducción y evacuación de humos  
Chimney systems and connecting flue pipes  
*Conduits de cheminée et systèmes d'évacuation de fumées*



Catálogo - Catalog - Catalogue  
**2023**

**ROS Group, de carácter estrictamente familiar, fue fundado en el año 1867 y desde siempre ha estado especializado en la fabricación de tubos y accesorios de chapa galvanizada, inoxidable y pulida con sistemas de unión tanto tradicionales como modulares de nueva generación.**

**ROS Group, strictly family-owned, was founded in the year 1867 and has always specialized in the manufacture of pipes and accessories made from galvanized, stainless steel and polished sheet metal with both traditional and contemporary modular joint systems.**

*ROS Group, à caractère strictement familial, a été fondée en 1867 et qui a toujours été spécialisée dans la fabrication de tuyaux et d'accessoires en tôle galvanisée, inoxydable et polie avec des systèmes d'union autant traditionnels que modulaires de nouvelle génération.*





ROS Group en la actualidad está formado por dos empresas: ROS DUCTING S.L.U., especializada en la fabricación de tubería modular industrial, y ROS CHIMNEYS, S.L.U., en la fabricación de tubería modular para la conducción y evacuación de humos.

Las instalaciones de ROS DUCTING, ubicadas en Sant Jaume de Llierca (Girona), cuentan con una superficie total de 12.000 m<sup>2</sup>, incluyendo un almacén a 7 niveles con una superficie útil de 30.000 m<sup>2</sup>. Por otra parte, las instalaciones de ROS CHIMNEYS, ubicadas en El Pla de Santa Maria (Tarragona), cuentan con una superficie total de 6.000 m<sup>2</sup>, incluyendo un almacén a 6 niveles con una superficie útil de 10.000 m<sup>2</sup>.

Ambas disponen de un amplísimo parque de maquinaria, moderno y con los últimos avances tecnológicos, además de un gran número de utillajes de diseño propio, a fin de lograr un continuo y alto estándar de calidad, respeto por el medio ambiente y excelentes condiciones de trabajo de sus empleados.

ROS Group currently consists of two companies: ROS DUCTING S.L.U., specialized in the manufacture of industrial modular ducting, and ROS CHIMNEYS, S.L.U., in the manufacture of modular ducting especially designed for venting and evacuating fumes.

ROS DUCTING facilities, located in Sant Jaume de Llierca (Girona), have a total area of 12,000 m<sup>2</sup>, including a 7-level warehouse with a useful area of 30,000 m<sup>2</sup>. On the other hand, ROS CHIMNEYS facilities, located in El Pla de Santa Maria (Tarragona), have a total area of 6,000 m<sup>2</sup>, including a 6-level warehouse with a useful area of 10,000 m<sup>2</sup>.

Both have a wide range of modern machinery, with the latest technological advances, as well as a large number of own-designed tools, with the aim of achieving a continuous and high-quality standard, respect for the environment and excellent working conditions of its employees.

*ROS Group comprend actuellement deux entreprises : ROS DUCTING, S.L.U., spécialisée en fabrication de tuyauterie modulaire industrielle, et ROS CHIMNEYS, S.L.U., en fabrication de tuyauterie modulaire pour la conduite et l'évacuation de fumées.*

*Les installations de ROS DUCTING, situées à Sant Jaume de Llierca (Girona), ont une surface totale de 12 000 m<sup>2</sup>, dont un entrepôt à 7 niveaux avec une surface utile de 30 000 m<sup>2</sup>. D'autre part, les installations de ROS CHIMNEYS, situées à El Pla de Santa Maria (Tarragone), ont une surface totale de 6 000 m<sup>2</sup>, dont un entrepôt à 6 niveaux avec une surface utile de 10 000 m<sup>2</sup>.*

*Les deux disposent d'une large gamme de machines modernes, dotées des dernières avancées technologiques, ainsi qu'un grand nombre d'outils conçus par nos soins, dans le but d'atteindre un standard de qualité continu et élevé, le respect de l'environnement et d'excellentes conditions de travail de ses employés.*





Nuestras Oficinas Técnicas, apoyadas por los Departamentos de I+D, ofrecen todo el soporte técnico y asesoramiento necesarios para el diseño y construcción de proyectos adaptados a las necesidades del cliente.

La acción de nuestros Departamentos Comerciales está basada en alcanzar con nuestros clientes una relación de confianza, comprometida y estable, estando siempre a su disposición para atenderles de forma rápida y eficaz.

El servicio esmerado, ágil y eficiente de nuestros Departamentos de Expediciones, con el apoyo de los principales agentes logísticos, hace que nuestros clientes reciban puntualmente sus pedidos.

Our Technical Departments, assisted by the R&D Departments, provide all technical support and assessment for the design and construction of projects suited to the customer needs.

The action of our Sales Departments staff works on the basis of trust, commitment and stability with our clients, providing personal, rapid and effective service when and where they need it.

Our Logistics Departments efficiency is supported by leading logistics transport agents to ensure the best and swiftly delivery times to all customers.



*Les Bureaux Techniques, renforcés par les Départements de R&D, assurent tout le support technique et l'expertise pour la conception et la réalisation de projets adaptés aux besoins des clients.*

*L'action des Départements Commerciales repose sur la confiance, l'engagement et la stabilité avec nos clients, en leur offrant un service personnalisé, rapide et efficace quand et où ils en ont besoin.*

*Le service attentif, agile et efficace de nos Départements d'Expéditions, avec le soutien des principaux agents logistiques, permettent d'assurer la livraison ponctuelle des commandes.*

ROS Group tiene la misión de convertirse en un *partner* estratégico de sus clientes, poniendo a su disposición un sistema de conductos de máxima calidad, con identidad propia, certificado y que ha sido proyectado y desarrollado íntegramente en sus instalaciones, a fin de buscar la plena satisfacción de los clientes, ofreciéndoles las soluciones que mejor se adapten a sus necesidades.

ROS Group has the mission of becoming a strategic partner of its clients, putting at their disposal a system of ducts of the highest quality, with its own identity, certified and that has been designed and developed entirely in its facilities, to achieve the satisfaction of the clients by offering them solutions adapted to their needs.

*ROS Group a pour mission de devenir un partenaire stratégique pour ses clients, en mettant à leur disposition un système de conduits de la plus haute qualité, avec sa propre identité, certifié et entièrement conçu et développé dans ses installations, pour atteindre la satisfaction des clients en leur proposant des solutions adaptées à leurs besoins.*



ROS Group se considera hoy día como uno de los fabricantes de tubería modular metálica con más prestigio y proyección del mundo, y cuenta con una amplia cartera de clientes tanto de ámbito nacional como internacional, que constituyen una referencia en sus respectivos países.

ROS Group is today one of the most prestigious manufacturers of metallic modular ducting in the world, with a large clientele in both the national and international arena, clients with respected reputations in their respective countries.

*ROS Group est aujourd'hui l'un des fabricants de tuyauterie modulaire métallique les plus prestigieux du monde, avec une clientèle large sur la scène nationale et internationale, et à la fois réputée dans leurs pays respectifs.*



Los productos fabricados en las empresas de ROS Group se utilizan en un rango muy variado de aplicaciones y sectores, tales como:

- **Extracción de polvo, aire, humos, neblinas y subproductos a escape libre o a filtros y ciclones**  
Sistemas de tubería para captación y aspiración para filtración de polvo, vahos, olores y humos contaminantes.
- **Transporte neumático y distribución de sólidos en líneas de producción**  
Sistemas de tubería para captación y transporte neumático a baja presión de productos en procesos de fabricación, así como caída gravitacional para el transporte y envasado de productos a granel.
- **Sistemas de calefacción, agua caliente sanitaria y biomasa**  
Sistemas de tubería para estufas, calderas y chimeneas de leña, carbón, gasoil, pellet, así como también instalaciones de biomasa y evacuación de aire, humos y gases.
- **Ventilación, climatización y refrigeración de procesos industriales y domésticos**  
Sistemas de tubería para impulsión, extracción y evacuación de aire, vapores y humos para la ventilación, climatización y refrigeración de procesos industriales y domésticos.



The products manufactured in ROS Group companies are used in a wide range of applications and sectors, such as:

- **Dust extraction, exhaust air, fumes, oil mist and by-products removal to the open air or to filters and ciclones**  
Pipework systems for collection and aspiration of dust, vapors, odors in filtration processes.
- **Pneumatic transport and distribution of bulk solids in manufacturing processes**  
Pipework systems for low pressure conveying of products in manufacturing processes, as well as gravitational fall and bulk goods conveying.
- **Heating systems, sanitary hot water and biomass**  
Pipework systems for stoves, boilers and fireplaces of firewood, coal, gasoil, pellet, as well as biomass installations and evacuation of air, smoke and gases.
- **Ventilation, air conditioning and refrigeration of industrial and domestic processes**  
Pipework systems for impulsion, extraction and evacuation of air, vapors and fumes for ventilation, air conditioning and refrigeration of industrial and domestic processes.



Les produits fabriqués dans les sociétés du groupe ROS sont utilisés dans un large éventail d'applications et de secteurs, tels que:

- **Extraction de poussière, air d'échappement, fumées, brouillard d'huile et des sous-produits à échappement libre ou à conduction à filtres et ciclones**  
Systèmes de tuyauterie pour le dépoussiérage et aspiration de vapeurs, d'odeurs et de particules dans les procédés de filtration.
- **Transport pneumatique et distribution de granulés dans les lignes de production**  
Systèmes de tuyauterie pour la collecte pneumatique et le transport à basse pression des produits dans les processus de fabrication, ainsi que la chute gravitationnelle pour le transport et l'emballage des produits en vrac.
- **Systèmes de chauffage, eau chaude sanitaire et biomasse**  
Systèmes de tuyauterie pour les poêles, les chaudières et les cheminées de bois de chauffage, charbon, diesel, granulés, ainsi que les installations de biomasse et l'évacuation de l'air, des fumées et des gaz.
- **Ventilation, climatisation et refroidissement des processus industriels et domestiques**  
Systèmes de tuyauterie pour l'impulsion, l'extraction et l'évacuation de l'air, des vapeurs et des fumées pour la ventilation, la climatisation et le refroidissement des processus industriels et domestiques.



## ÁREAS DE UTILIZACIÓN · AREAS OF USE · DOMAINES D'UTILISATION



Biomasa  
Biomass  
Biomasse



Calefacción  
Heating  
Chauffage



Industrial  
Industrial  
Industriel



Ventilación  
Ventilation  
Ventilation

## MATERIAL RECOMENDADO SEGÚN TIPO DE COMBUSTIBLE RECOMMENDED MATERIAL ACCORDING TO FUEL TYPE MATÉRIEL RECOMMANDÉ SELON LE TYPE DE CARBURANT

Combustibles Fuels Carburants	Materiales Materials Matériels	Capítulos relacionados Related chapters Chapitres associés
	304  304L  316L  904L  VITRI	1  2  3  4  5  7  8
	316L  904L  PP	1  2  3  4  5  11
	316L  904L  VITRI  PP	1  2  3  4  5  7  8  11
	304  304L  316L  904L  VITRI	1  2  3  5  7  8
	316L  904L  PP	1  2  3  5  11
	316L  904L  VITRI  PP	1  2  3  5  7  8  11
	316L  904L  VITRI	1  2  3  6  7  8
	316L  904L  VITRI	1  2  3  6  7  8
	316L  904L  VITRI	1  2  3  6  7  8
	904L  VITRI	7  8

## COMBUSTIBLES · FUELS · CARBURANTS



GAS  
GAZ



FUEL



COMBUSTIBLES SÓLIDOS  
SOLID FUELS  
COMBUSTIBLES SOLIDES



CONDENSACIÓN  
CONDENSATION



BAJA TEMPERATURA  
LOW TEMPERATURE  
BASSE TEMPÉRATURE



LEÑA  
WOOD  
BOIS



PELLET



CARBÓN  
COAL  
CHARBON



CEREALES  
CEREALS  
CÉRÉALES

## MATERIALES · MATERIALS · MATÉRIELS

Acero inoxidable | Stainless steel | Acier inoxydable

AISI 304

1.4301

AISI 304L

1.4307

AISI 316L

1.4404

AISI 904L

1.4539

Vitrificado negro | Vitriified black | Vitriifié noir

VITRI

DC01EK AM O

Polipropileno | Polypropylene | Polypropylène

PP

## CERTIFICACIONES · CERTIFICATIONS · CERTIFICATIONS



Sistema de Gestión  
Management System  
Système de Gestion  
ISO 9001  
ISO 14001



Certificado CE  
CE certificate  
Certificat CE



Marca Aenor  
Aenor mark  
Marquage Aenor



Producto aprobado por HETAS  
HETAS approved product  
Produit approuvé par HETAS



Documento aprobado por CSTB  
Document approved by CSTB  
Document approuvé par CSTB



Documento aprobado por CSTB  
Document approved by CSTB  
Document approuvé par CSTB



Resistente al fuego  
Fire resistant  
Résistant au feu

IMPORTANTE: Esta información es una referencia general. Cada país tiene su reglamentación específica. Por favor, contacte con nuestro servicio técnico para más información.

IMPORTANT: This information is a general reference. Each country has its own specific regulations. Please contact our technical service for more information.

IMPORTANT: Cette information est pour référence générale. Chaque pays a ses règles spécifiques. S'il vous plaît contacter notre service technique pour plus de détails.

**DOBLE PARED | DOUBLE WALL | DOUBLE PAROI**



**SIMPLE PARED | SINGLE WALL | SIMPLE PAROI**



**CONCÉNTRICO | CONCENTRIC | CONCENTRIQUE**

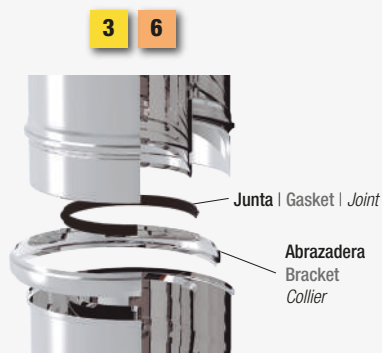

<b>1</b> <b>DP</b>	DOBLE PARED DOUBLE WALL DOUBLE PAROI	8
<b>2</b> <b>SP</b>	SIMPLE PARED SINGLE WALL SIMPLE PAROI	32
<b>3</b> <b>CC</b>	CONDUCTO CONCÉNTRICO CONCENTRIC PIPING CONDUIT CONCENTRIQUE	58
<b>4</b> <b>EI</b>	RESISTENCIA AL FUEGO EI FIRE RESISTANCE EI RÉSISTANCE AU FEU EI	70
<b>5</b> <b>DP50</b>	DOBLE PARED 50 MM 50 MM DOUBLE WALL DOUBLE PAROI 50 MM	86
<b>6</b> <b>TP</b>	TUBERÍA PELLET Y LEÑA PELLET AND FIREWOOD PIPING TUBAGE POËLE À PELLETS ET BOIS DE CHAUFFAGE	100
<b>7</b> <b>F</b>	FUMISTERÍA CONNECTING FLUE PIPE FUMISTERIE	114
<b>8</b> <b>CF</b>	CONDUCTO FLEXIBLE FLEXIBLE PIPING CONDUIT FLEXIBLE	122
<b>9</b> <b>BD</b>	BAJANTE DE DESCARGA REFUSE CHUTE CONDUIT DE CHUTE	126
<b>10</b> <b>AC</b>	ACCESORIOS ACCESSORIES ACCESSOIRES	130
<b>11</b> <b>CP</b>	CONDUCTO DE POLIPROPILENO POLYPROPYLENE PIPING CONDUIT DE POLYPROPYLÈNE	140
<b>12</b> <b>Info</b>	Información general, condiciones de venta y garantía General information, sales terms and warranty Informations générales, conditions de vente et garantie	142

# 1 DP

Doble Pared  
Double Wall  
Double Paroi

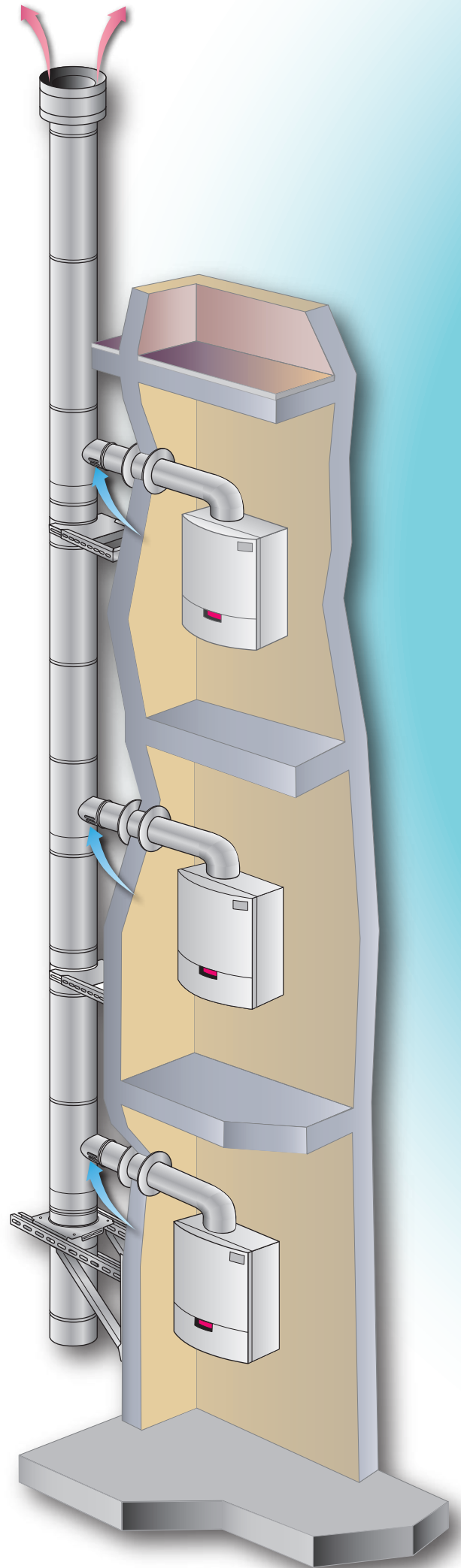
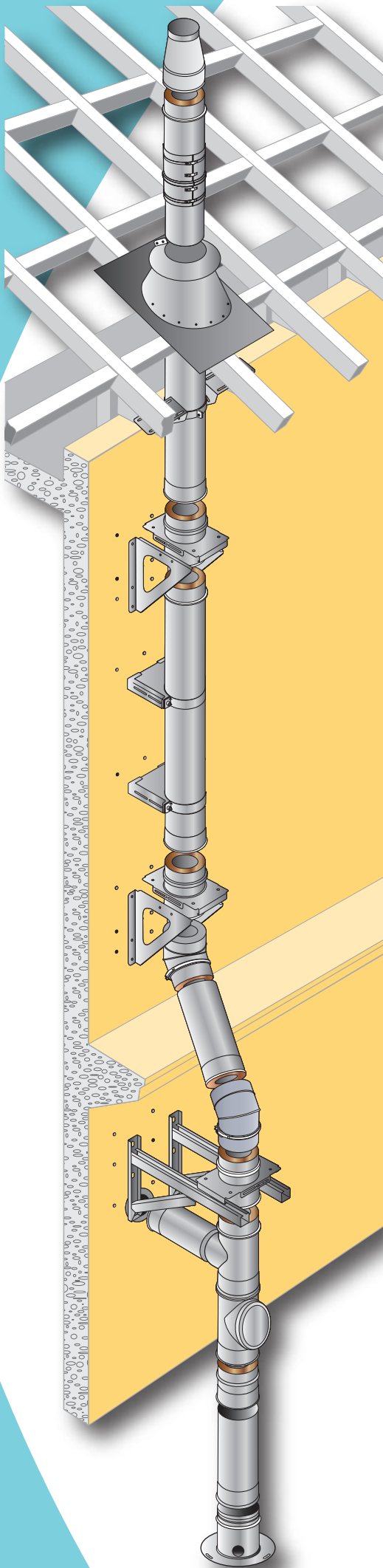



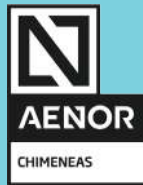

Núm. 14.2/15-2103\_V1



**ROS Pellet**

Núm. 14.2/22-2307\_V1

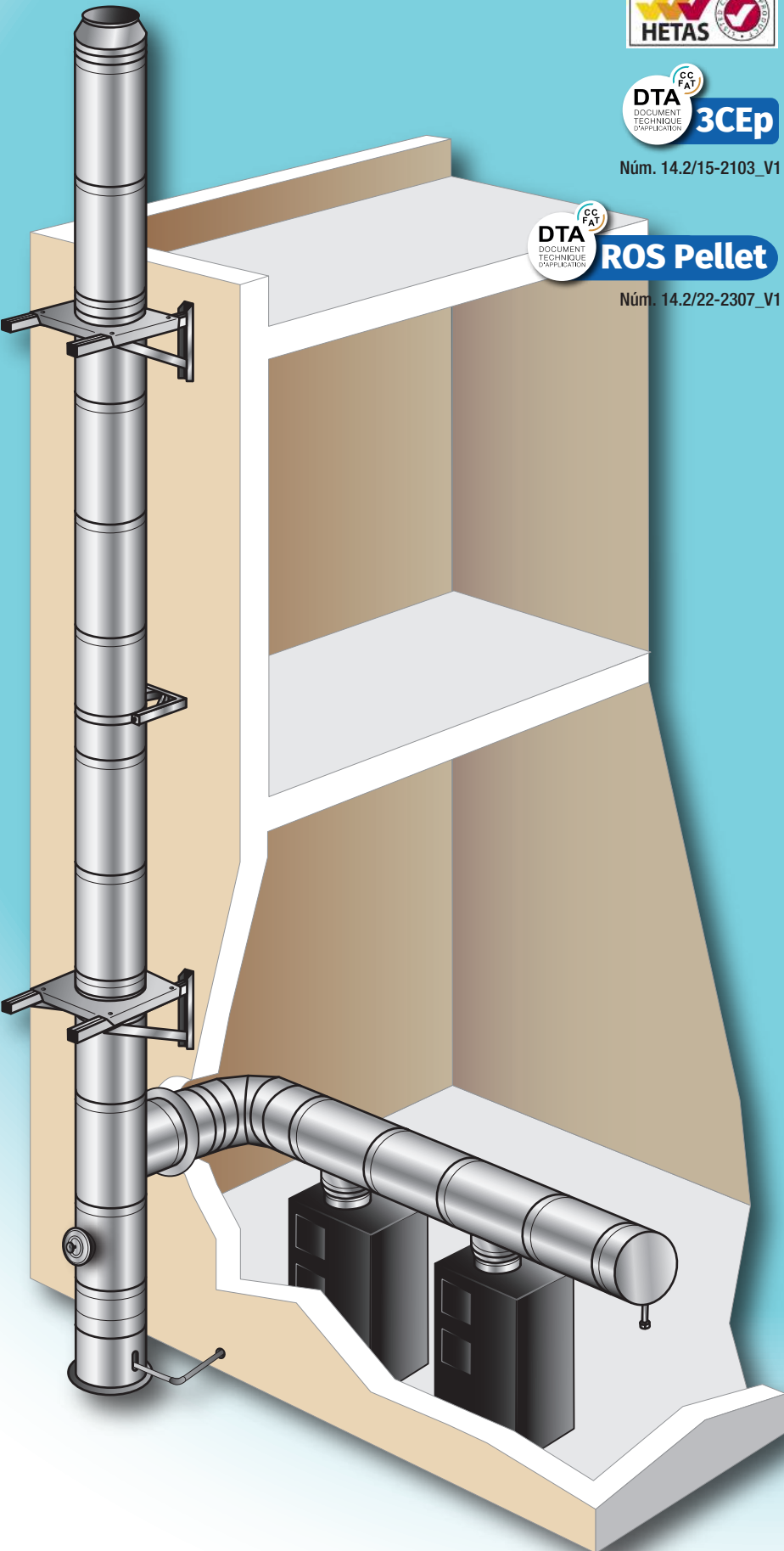

**CE** Especificaciones de acuerdo a la legislación europea en productos de construcción **CPR**  
 Specifications according to EU product regulations of construction **CPR**  
*Spécifications Selon la réglementation européenne concernant les produits de construction **CPR***

Esesor Thickness Épaisseur		ø80-250 ..... <b>0,4 mm</b> ø300-400 ..... <b>0,5 mm</b> ø450-650 ..... <b>0,6 mm</b>
----------------------------------	--	---

Aislante Insulation Isolation		25 mm	Lana de roca Rock wool Laine de roche
-------------------------------------	--	-------	---



interior y exterior | inside and outside | intérieur et extérieur

**AISI 304**

(1.4301) **2R**

**EN 1856-1**

- T200 P1 W Vm L20040 O(15)\*
- T200 N1 W Vm L20040 O(15)
- T450 N1 W Vm L20040 O(40)
- T600 N1 W Vm L20040 O(45)
- T600 N1 D Vm L20040 G(70)



interior | inside | intérieur

**AISI 316L**

(1.4404) **2R**

exterior | outside | extérieur

**AISI 304**

(1.4301) **2R**

**EN 1856-1**

- T200 P1 W V2 L50040 O(15)\*
- T200 N1 W V2 L50040 O(15)
- T450 N1 W V2 L50040 O(40)
- T600 N1 W V2 L50040 O(45)
- T600 N1 D V2 L50040 G(70)



interior | inside | intérieur

**AISI 904L**

(1.4539) **2R**

exterior | outside | extérieur

**AISI 304**

(1.4301) **2R**

\* Consultar Departamento Comercial  
 Consult Sales Department  
 Consulter le Département Commercial

**Notas: | Notes:**

Para diámetros superiores a Ø300 mm, la distancia a los materiales combustibles se debe incrementar mediante un coeficiente.

For diameters more than Ø300 mm, the distance to combustible materials must be increased by a coefficient.

Pour les diamètres supérieurs à Ø300 mm, la distance par rapport aux matériaux combustibles doit être augmentée par un coefficient.

<b>XX Distancia   Distance:</b>	x1,5 (Ø350-450)
	x2 (Ø500-600)
	x3 (Ø650)

\* Para cumplir con esta designación todos los elementos deben estar instalados con juntas, consulte la página 26. Para saber el número de juntas, consulte la página 142. Para el resto de elementos, la junta es opcional.

\* To comply with this designation, all elements must be installed with gaskets, see page 26. For the number of gaskets, see page 142. For all other elements, the gasket is optional.

\* Pour respecter cette désignation, tous les éléments doivent être installés avec des joints, voir page 26. Unités de joints par élément, voir page 142. Pour tous les autres éléments, le joint est optionnel.

#### Módulo lineal | Linear module | Élément droit



1000

500

250

ØDi mm **80 100 125 130 150 180 200 250**

#### L 1000 mm

AISI	Ref.	ØDi mm							
		80	100	125	130	150	180	200	250
304-304	2700620	2700021	4013503	2700104	2700172	2700226	2700275	2700334	
	€ U.	77,25	84,80	98,80	100,10	107,95	125,60	136,65	191,65
316L-304	4600500**	4600501**	4016250	4016251	4014573	4015912	4009371	4014574	
	€ U.	99,75	109,90	126,55	128,25	139,65	162,45	176,75	247,90

#### L 500 mm

AISI	Ref.	ØDi mm							
		80	100	125	130	150	180	200	250
304-304	2700621	2700020	4013502	2700103	2700171	2700225	2700274	2700333	
	€ U.	44,55	52,80	62,45	63,25	67,95	75,80	81,55	107,00
316L-304	4600510**	4600511**	4016255	4015051	4014488	4016257	4014489	4011636	
	€ U.	56,90	67,50	80,00	81,10	86,60	97,60	104,95	137,80

#### L 250 mm

AISI	Ref.	ØDi mm							
		80	100	125	130	150	180	200	250
304-304	4007485	2700019	4013500	2700102	2700170	2700224	2700273	2700332	
	€ U.	35,85	39,40	48,45	49,15	50,30	58,85	63,75	92,55
316L-304	4013602**	4016260**	4016261	4016262	4014490	4016263	4014491	4011774	
	€ U.	43,50	47,75	60,15	61,00	61,20	73,05	79,15	114,95

#### Módulo extensible | Extendable module | Élément télescopique



500-900

335-565

200-300

ØDi mm **80 100 125 130 150 180 200 250**

#### Lmin 500 mm - Lmax 900 mm

AISI	Ref.	ØDi mm							
		80	100	125	130	150	180	200	250
304-304	4008852	4008941	4013526	2700100	2700168	2700222	2700271	2700331	
	€ U.	128,10	138,90	150,25	152,25	153,85	184,25	198,45	290,50
316L-304	4600560**	4600561**	4016668	4016669	4008377	4016670	4014500	4011772	
	€ U.	161,85	175,45	189,95	192,45	199,90	234,95	257,90	377,65

#### Lmin 335 mm - Lmax 565 mm

AISI	Ref.	ØDi mm							
		80	100	125	130	150	180	200	250
304-304	2700622	2700018	4013525	2700098	2700166	2700220	2700269	2700329	
	€ U.	88,25	92,15	111,75	113,10	116,75	128,55	144,95	179,95
316L-304	4700650**	4700651**	4016665	4015052	4014495	4016666	4014365	4011773	
	€ U.	115,60	127,15	141,05	142,90	151,05	165,50	184,85	226,20

#### Lmin 200 mm - Lmax 300 mm

AISI	Ref.	ØDi mm							
		80	100	125	130	150	180	200	250
304-304	4007712	4008942	4013524	2700101	2700169	2700223	2700272	4007715	
	€ U.	61,85	71,75	75,15	79,00	84,45	99,95	127,50	159,15
316L-304	4700660**	4016659**	4016660	4016661	4014496	4016662	4014497	4014499	
	€ U.	75,35	91,30	105,00	105,75	106,65	125,25	170,55	183,05

#### Codo | Elbow | Coude 15°



ØDi mm **80 100 125 130 150 180 200 250**

AISI	Ref.	ØDi mm							
		80	100	125	130	150	180	200	250
304-304	4015142	4015143	4015144	4015145	4015146	4015147	4015148	4015149	
	€ U.	52,50	54,55	61,20	62,30	68,75	88,00	94,95	117,30
316L-304	4016570**	4016571**	4016572	4016573	4016574	4016575	4016576	4016577	
	€ U.	67,95	71,80	81,30	82,40	89,10	114,25	122,15	141,85

Medidas | Measurements | Mesures

	H	11	11	11	12	12	13	13
V	123	126	130	130	132	136	139	145

#### Codo | Elbow | Coude 30°



ØDi mm **80 100 125 130 150 180 200 250**

AISI	Ref.	ØDi mm							
		80	100	125	130	150	180	200	250
304-304	4008007	2700015	4013538	2700094	2700162	2700215	2700264	2700324	
	€ U.	52,50	54,55	61,20	62,30	68,75	88,00	94,95	117,30
316L-304	4015622**	4016580**	4016581	4016582	4014553	4016583	4014576	4011638	
	€ U.	67,95	71,80	81,30	82,40	89,10	114,25	122,15	141,85

Medidas | Measurements | Mesures

	H	25	26	28	28	29	32	33	36
V	136	141	148	148	153	161	166	178	

Ref.	2700172	Unidades de embalaje Packing units Unités d'emballage
€ U.	107,95 <sup>1</sup>	



**Abrazadera de unión incluida en todas las piezas.**  
Connection bracket included in all parts.  
*Collier de fixation inclus dans toutes les pièces.*



**Junta incluida.**  
Gasket included.  
*Joint inclus.*

**\*\* ø80 - 100**

**1**

300	350	400	450	500	550	600	650
-----	-----	-----	-----	-----	-----	-----	-----

2700390	2700427	4027339	4007145	4032136	4032137	4032138	4032139
<b>248,90</b> <sup>1</sup>	<b>274,50</b> <sup>1</sup>	<b>351,70</b> <sup>1</sup>	<b>405,80</b> <sup>1</sup>	<b>458,35</b> <sup>1</sup>	<b>522,35</b> <sup>1</sup>	<b>602,35</b> <sup>1</sup>	<b>690,80</b> <sup>1</sup>
4009452	4016252	4029496	4029649	4029671	4029805	4030010	4030101
<b>323,55</b> <sup>1</sup>	<b>356,75</b> <sup>1</sup>	<b>426,90</b> <sup>1</sup>	<b>484,65</b> <sup>1</sup>	<b>540,85</b> <sup>1</sup>	<b>603,00</b> <sup>1</sup>	<b>683,40</b> <sup>1</sup>	<b>770,00</b> <sup>1</sup>

2700389	2700426	4032126	4032128	4032132	4032133	4032134	4032135
<b>134,05</b> <sup>1</sup>	<b>166,70</b> <sup>1</sup>	<b>209,65</b> <sup>1</sup>	<b>247,60</b> <sup>1</sup>	<b>297,65</b> <sup>1</sup>	<b>353,85</b> <sup>1</sup>	<b>424,10</b> <sup>1</sup>	<b>469,20</b> <sup>1</sup>
4014742	4014404	4029497	4029552	4029673	4029809	4030012	4030103
<b>172,60</b> <sup>1</sup>	<b>192,80</b> <sup>1</sup>	<b>243,35</b> <sup>1</sup>	<b>282,65</b> <sup>1</sup>	<b>338,85</b> <sup>1</sup>	<b>386,85</b> <sup>1</sup>	<b>455,15</b> <sup>1</sup>	<b>495,25</b> <sup>1</sup>

2700388	2700425	4032118	4032121	4032122	4032123	4032124	4032125
<b>103,30</b> <sup>1</sup>	<b>127,80</b> <sup>1</sup>	<b>173,10</b> <sup>1</sup>	<b>213,45</b> <sup>1</sup>	<b>284,95</b> <sup>1</sup>	<b>329,25</b> <sup>1</sup>	<b>388,10</b> <sup>1</sup>	<b>416,60</b> <sup>1</sup>
4016264	4016265	4029498	4029551	4029672	4029808	4030011	4030102
<b>121,80</b> <sup>1</sup>	<b>148,85</b> <sup>1</sup>	<b>207,30</b> <sup>1</sup>	<b>235,60</b> <sup>1</sup>	<b>306,75</b> <sup>1</sup>	<b>352,65</b> <sup>1</sup>	<b>398,10</b> <sup>1</sup>	<b>430,75</b> <sup>1</sup>

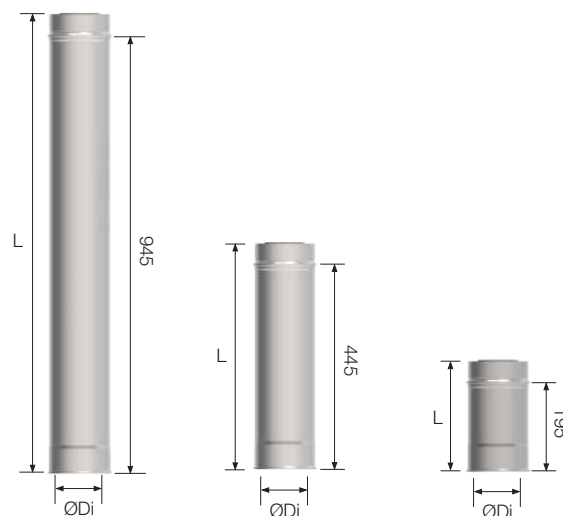

300	350	400	450	500	550	600	650
-----	-----	-----	-----	-----	-----	-----	-----

2700386	2700424	4032446	4032447	4032448	4032449	4032450	4032451
<b>320,20</b> <sup>1</sup>	<b>419,80</b> <sup>1</sup>	<b>477,45</b> <sup>1</sup>	<b>553,75</b> <sup>1</sup>	<b>603,10</b> <sup>1</sup>	<b>662,15</b> <sup>1</sup>	<b>712,45</b> <sup>1</sup>	<b>776,00</b> <sup>1</sup>
4014743	4016671	4029472	4029535	4029658	4029768	4029979	4030078
<b>420,25</b> <sup>1</sup>	<b>511,45</b> <sup>1</sup>	<b>579,75</b> <sup>1</sup>	<b>649,20</b> <sup>1</sup>	<b>711,65</b> <sup>1</sup>	<b>750,65</b> <sup>1</sup>	<b>793,70</b> <sup>1</sup>	<b>849,35</b> <sup>1</sup>

2700385	2700423	4032435	4032436	4032441	4032443	4032444	4032445
<b>228,70</b> <sup>1</sup>	<b>284,55</b> <sup>1</sup>	<b>343,25</b> <sup>1</sup>	<b>402,65</b> <sup>1</sup>	<b>460,65</b> <sup>1</sup>	<b>538,05</b> <sup>1</sup>	<b>575,90</b> <sup>1</sup>	<b>628,30</b> <sup>1</sup>
4012406	4012421	4029471	4029534	4029657	4029766	4029978	4030077
<b>301,75</b> <sup>1</sup>	<b>342,05</b> <sup>1</sup>	<b>396,50</b> <sup>1</sup>	<b>457,65</b> <sup>1</sup>	<b>521,95</b> <sup>1</sup>	<b>568,25</b> <sup>1</sup>	<b>618,90</b> <sup>1</sup>	<b>678,90</b> <sup>1</sup>

2700387	4022030	4032452	4032453	4032454	4032459	4032460	4032461
<b>181,35</b> <sup>1</sup>	<b>254,15</b> <sup>1</sup>	<b>329,00</b> <sup>1</sup>	<b>383,85</b> <sup>1</sup>	<b>458,45</b> <sup>1</sup>	<b>518,70</b> <sup>1</sup>	<b>558,00</b> <sup>1</sup>	<b>611,15</b> <sup>1</sup>
4016663	4021191	4032462	4032463	4031694	4032464	4032465	4032466
<b>227,30</b> <sup>1</sup>	<b>305,50</b> <sup>1</sup>	<b>379,65</b> <sup>1</sup>	<b>435,60</b> <sup>1</sup>	<b>499,15</b> <sup>1</sup>	<b>543,30</b> <sup>1</sup>	<b>588,40</b> <sup>1</sup>	<b>633,15</b> <sup>1</sup>

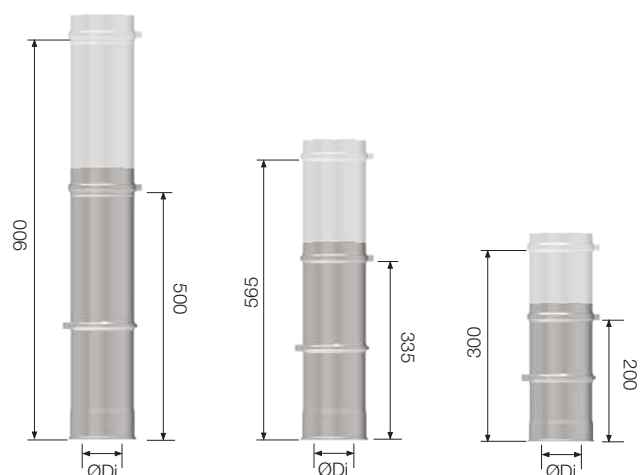

300	350	400	450	500	550	600	650
-----	-----	-----	-----	-----	-----	-----	-----

4015150	4015151	4032574	4032568	4032569	4032571	4032572	4032573
<b>173,55</b> <sup>1</sup>	<b>218,75</b> <sup>1</sup>	<b>332,00</b> <sup>1</sup>	<b>395,10</b> <sup>1</sup>	<b>470,10</b> <sup>1</sup>	<b>585,20</b> <sup>1</sup>	<b>718,30</b> <sup>1</sup>	<b>839,15</b> <sup>1</sup>
4016578	4016579	4029465	4029525	4029652	4029754	4029974	4030073
<b>221,45</b> <sup>1</sup>	<b>285,65</b> <sup>1</sup>	<b>381,60</b> <sup>1</sup>	<b>455,00</b> <sup>1</sup>	<b>530,25</b> <sup>1</sup>	<b>679,40</b> <sup>1</sup>	<b>784,25</b> <sup>1</sup>	<b>916,55</b> <sup>1</sup>

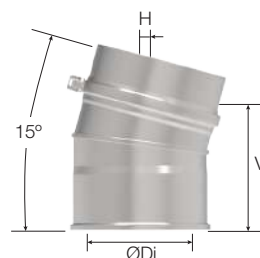

14	15	30	31	32	33	34	35
152	158	278	285	291	298	304	311

300	350	400	450	500	550	600	650
-----	-----	-----	-----	-----	-----	-----	-----

2700380	2700419	4032575	4032558	4032559	4032560	4032566	4032567
<b>173,55</b> <sup>1</sup>	<b>218,75</b> <sup>1</sup>	<b>332,00</b> <sup>1</sup>	<b>395,10</b> <sup>1</sup>	<b>470,10</b> <sup>1</sup>	<b>585,20</b> <sup>1</sup>	<b>718,30</b> <sup>1</sup>	<b>839,15</b> <sup>1</sup>
4009453	4016585	4029466	4029526	4029653	4029755	4029975	4030074
<b>221,45</b> <sup>1</sup>	<b>285,65</b> <sup>1</sup>	<b>381,60</b> <sup>1</sup>	<b>455,00</b> <sup>1</sup>	<b>530,25</b> <sup>1</sup>	<b>679,40</b> <sup>1</sup>	<b>784,25</b> <sup>1</sup>	<b>916,55</b> <sup>1</sup>

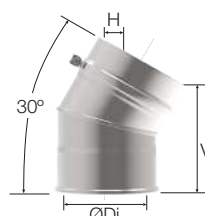

40	43	89	93	97	100	103	107
191	203	383	396	409	421	434	446

Codo | Elbow | Coude **45°**



		ØDi mm							
		80	100	125	130	150	180	200	250
AISI <b>304-304</b>	Ref.	2700624	2700016	4013539	2700095	2700163	2700217	2700265	2700325
	€ U.	<b>55,55</b>	<b>57,65</b>	<b>64,65</b>	<b>65,85</b>	<b>72,80</b>	<b>93,05</b>	<b>100,40</b>	<b>124,15</b>
AISI <b>316L-304</b>	Ref.	4600530**	4600531**	4016587	4015053	4008379	4016588	4012119	4011639
	€ U.	<b>71,90</b>	<b>74,65</b>	<b>86,00</b>	<b>87,20</b>	<b>94,25</b>	<b>120,90</b>	<b>129,30</b>	<b>161,25</b>
Medidas   Measurements   Mesures									
H		42	43	47	47	50	54	57	63
V		145	151	161	161	167	178	185	202

Codo | Elbow | Coude **87°**



		ØDi mm							
		80	100	125	130	150	180	200	250
AISI <b>304-304</b>	Ref.	4021737	4021739	4021740	4021741	4021742	4021743	4021744	4021745
	€ U.	<b>104,85</b>	<b>110,05</b>	<b>117,30</b>	<b>125,20</b>	<b>132,35</b>	<b>168,75</b>	<b>169,35</b>	<b>207,45</b>
AISI <b>316L-304</b>	Ref.	4600520**	4600521**	4020187	4019671	4019672	4019673	4019674	4019675
	€ U.	<b>123,75</b>	<b>133,25</b>	<b>151,20</b>	<b>155,80</b>	<b>161,95</b>	<b>203,40</b>	<b>207,00</b>	<b>272,35</b>
Medidas   Measurements   Mesures									
H		114	124	137	137	146	160	170	194
V		163	173	187	187	197	212	222	247

Codo | Elbow | Coude **90°**



		ØDi mm							
		80	100	125	130	150	180	200	250
AISI <b>304-304</b>	Ref.	-	-	-	4021730	4021731	4021732	4021733	4021734
	€ U.	-	-	-	<b>140,10</b>	<b>152,00</b>	<b>173,30</b>	<b>201,75</b>	<b>241,15</b>
Medidas   Measurements   Mesures									
H		-	-	-	137	146	160	170	194
V		-	-	-	187	197	212	222	247

Te | "T" piece | Tê **90° \***



		ØDi mm							
		80	100	125	130	150	180	200	250
AISI <b>304-304</b>	Ref.	4021799	4021800	4021801	4021802	4021803	4021804	4021805	4021807
	€ U.	<b>86,55</b>	<b>97,30</b>	<b>105,60</b>	<b>107,40</b>	<b>109,65</b>	<b>133,15</b>	<b>146,95</b>	<b>197,60</b>
AISI <b>316L-304</b>	Ref.	4019993**	4019994**	4020162	4019996	4019997	4019998	4019999	4020000
	€ U.	<b>112,55</b>	<b>126,35</b>	<b>136,60</b>	<b>138,95</b>	<b>146,80</b>	<b>182,20</b>	<b>190,95</b>	<b>250,90</b>
Medidas   Measurements   Mesures									
L		244	278	295	295	315	345	365	445
H		144	161	169	169	179	194	204	244
V		159	169	183	183	193	208	218	243

Te | "T" piece | Tê **93° \***



		ØDi mm							
		80	100	125	130	150	180	200	250
AISI <b>316L-304</b>	Ref.	4600570**	4600571**	4021758	4021759	4021761	4021762	4021763	4021764
	€ U.	<b>112,55</b>	<b>126,35</b>	<b>136,60</b>	<b>138,95</b>	<b>146,80</b>	<b>182,20</b>	<b>190,95</b>	<b>250,90</b>
Medidas   Measurements   Mesures									
L		245	277	295	295	314	344	365	444
H		162	173	187	187	198	214	224	251
V		138	154	161	161	171	185	194	233

Te | "T" piece | Tê **135° \***



		ØDi mm							
		80	100	125	130	150	180	200	250
AISI <b>304-304</b>	Ref.	4021770	4021772	4021773	4021774	4021776	4021778	4021779	4021780
	€ U.	<b>129,70</b>	<b>147,20</b>	<b>159,40</b>	<b>161,85</b>	<b>189,15</b>	<b>194,40</b>	<b>234,70</b>	<b>367,60</b>
AISI <b>316L-304</b>	Ref.	4021783**	4021786**	4021787	4021788	4021789	4021790	4021792	4021793
	€ U.	<b>172,85</b>	<b>223,10</b>	<b>244,70</b>	<b>247,85</b>	<b>285,65</b>	<b>299,95</b>	<b>354,10</b>	<b>543,80</b>
Medidas   Measurements   Mesures									
L		300	325	360	368	395	435	465	535
H		184	201	222	226	243	267	284	327
V		64	71	83	78	86	98	105	123

Ref.	2700163	Unidades de embalaje Packing units Unités d'emballage
€ U.	72,80	



**Abrazadera de unión incluida en todas las piezas.**  
Connection bracket included in all parts.  
*Collier de fixation inclus dans toutes les pièces.*



**Junta incluida.**  
Gasket included.  
*Joint inclus.*

**\*\* ø80 - 100**

300	350	400	450	500	550	600	650
2700381	2700420	2500154	4032552	4032554	4032555	4032556	4032557
183,65	236,45	344,90	418,05	495,45	632,60	777,00	907,10
4012423	4012422	4029467	4029528	4029654	4029756	4029976	4030075
227,30	307,10	401,65	478,85	558,15	700,40	825,50	964,75
70	77	151	159	166	173	181	188
219	236	416	434	451	469	487	504

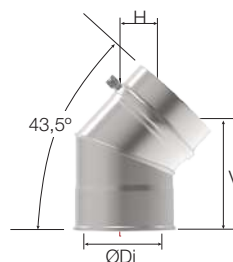

300	350	400	450	500	550	600	650
4021746	4021749	-	-	-	-	-	-
257,15	302,15	-	-	-	-	-	-
4019676	4019677	4029469	4029530	4029656	4029765	4029977	4030076
323,90	379,30	646,25	959,55	1.070,75	1.496,70	1.771,00	2.068,45
217	241	377	401	425	448	472	496
272	297	482	507	532	557	582	607

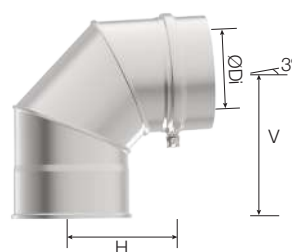

300	350	400	450	500	550	600	650
4021735	4021736	4025335	4032545	4032548	4032549	4032550	4032551
297,75	405,30	486,85	726,00	907,50	1.268,40	1.539,95	1.798,60
217	241	388	413	438	463	488	513
272	297	482	507	532	557	582	607

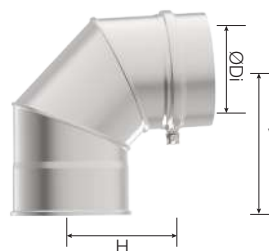

300	350	400	450	500	550	600	650
4021809	4021810	4029494	4029549	4029665	4029790	4030008	4030099
280,45	350,75	609,65	784,65	943,85	1.091,50	1.239,15	1.417,70
4020002	4020003	-	-	-	-	-	-
364,50	420,85	-	-	-	-	-	-
465	515	650	700	750	800	850	900
254	279	295	320	345	370	395	420
268	293	350	375	400	425	450	475



\* No incluye tapa  
Cover not included  
*Couvercle non inclus*

300	350	400	450	500	550	600	650
4021765	4021766	4029495	4029550	4029669	4029803	4030009	4030100
364,50	420,85	731,50	902,30	1.085,45	1.222,40	1.387,85	1.587,90
464	514	650	700	750	800	850	900
277	303	270	295	320	345	370	395
242	265	306	331	356	381	406	431

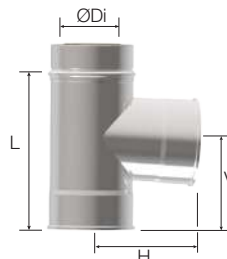

\* No incluye tapa  
Cover not included  
*Couvercle non inclus*

300	350	400	450	500	550	600	650
4021781	4021782	4033751	4033753	4033754	4033755	4033756	-
456,90	499,00	828,10	990,40	1.194,90	1.369,85	1.543,30	-
4021794	4021795	4033783	4033784	4033785	4033786	4033787	-
680,15	759,90	1.010,30	1.232,75	1.410,00	1.667,30	1.759,30	-
300	325	360	368	395	435	465	-
184	201	222	226	243	267	284	-
64	71	83	78	86	98	105	-



\* No incluye tapa  
Cover not included  
*Couvercle non inclus*

#### Tapa | Cap | Tampon



Ø80-350

Ø400-650

		ØDi mm							
		80	100	125	130	150	180	200	250
AISI 316L-304	Ref.	4015925**	4015931**	4025161	4015937	4015938	4015939	4015940	4015941
	€ U.	37,60 1	38,80 1	43,10 1	45,60 1	46,20 1	55,40 1	57,95 1	72,35 1

#### Tapa purga | Condensate cap | Tampon récupérateur condensats



Ø80-350

Ø400-650

		ØDi mm							
		80	100	125	130	150	180	200	250
AISI 316L-304	Ref.	4015936**	4015575**	4020053	4015943	4015952	4015944	4015867	4015945
	€ U.	40,50 1	42,10 1	43,90 1	46,95 1	47,70 1	56,50 1	59,75 1	74,60 1
Medidas   Measurements   Mesures									
H		30	30	30	30	30	30	30	30
ØG		1/2"	1/2"	1/2"	1/2"	1/2"	3/4"	3/4"	3/4"

#### Tapa purga lateral | Lateral Condensate cap | Tampon récupérateur condensats latéral



		ØDi mm					
		400	450	500	550	600	650
AISI 316L-304	Ref.	4040309	4040310	4040311	4040312	4040313	4040314
	€ U.	251,80 1	302,25 1	318,95 1	340,10 1	385,20 1	435,15 1
Medidas   Measurements   Mesures							
H		133	158	184	208	232	257

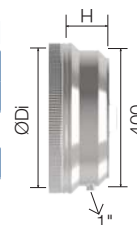

### Piezas específicas para instalaciones colectivas | Specific pieces for collective installations

#### Te reducida con admisión de aire a | Reduction "T" Piece air inlet to | Tè réduit avec prise d'air à



60 / 100 mm

		ØDi mm				
		100	125	130	150	
AISI 316L-304	Ref.	-	-	4022105	4022106	4022107
	€ U.	-	-	177,80 1	179,30 1	182,65 1

#### Te reducida con admisión de aire a | Reduction "T" Piece air inlet to | Tè réduit avec prise d'air à



80 / 125 mm

		ØDi mm				
		100	125	130	150	
AISI 316L-304	Ref.	-	-	9022111	9022112	4022113
	€ U.	-	-	168,90 1	173,45 1	175,15 1

#### Conducto de conexión + tapa | Connecting piping + cap | Conduit de liaison + tampon **RAL 9016**



		ØDi / ØDe mm	
		80/125	
AISI 316L-304	Ref.	4025843	
	€ U.	98,70 1	



#### Te reducida a | "T" Piece reduced to | Tè réduit à



80 mm

		ØDi mm			
		100	125	130	150
AISI 316L-304	Ref.	4017416**	4017418	4017419	4017420
	€ U.	182,00 1	197,30 1	199,85 1	222,25 1

Ref.	4015938	Unidades de embalaje Packing units Unités d'emballage
€ U.	46,20 1	



**Abrazadera de unión incluida en todas las piezas.**  
Connection bracket included in all parts.  
*Collier de fixation inclus dans toutes les pièces.*



**Junta incluida.**  
Gasket included.  
*Joint inclus.*

**\*\* ø80 - 100**

300	350	400	450	500	550	600	650
4015942	4015954	4029491	4029540	4029666	4029784	4030005	4030091
103,80 1	138,00 1	176,35 1	206,80 1	218,05 1	231,70 1	263,45 1	297,55 1

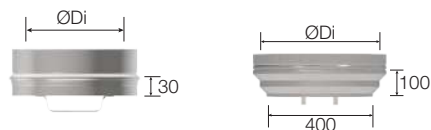

300	350	400	450	500	550	600	650
4013919	4014409	4029489	4029539	4029664	4029783	4030001	4030089
107,00 1	142,25 1	193,70 1	232,55 1	245,40 1	261,65 1	296,35 1	334,70 1

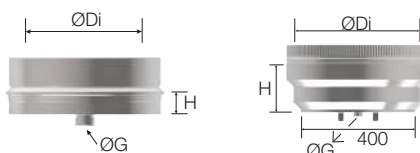

30	30	147	184	210	234	260	284
1"	1"	1"	1"	1"	1"	1"	1"

**Sifón | Siphon | Siphon**



Ref.	4030741
€ U.	41,00 1

max. 160° C

**Pièces spécifiques pour installations collectives**



180	200	250	300
4022108	4015866	4019371	4022110
191,75 1	195,35 1	233,60 1	256,95 1

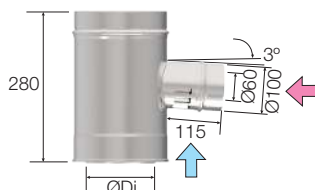

180	200	250	300
4022114	4022115	4022116	4022117
185,85 1	189,05 1	241,95 1	279,65 1

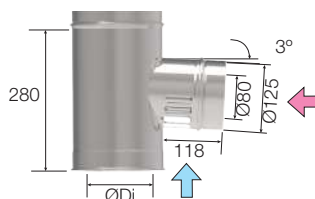

180	200	250	300
4017581	4017582	4017583	4013921
250,40 1	276,50 1	313,30 1	345,30 1

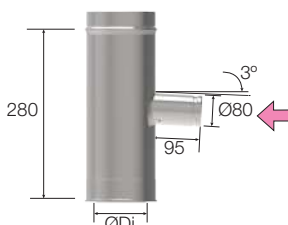

### Módulo de inspección | Inspection module | Module d'inspection \*



		ØDi mm							
		80	100	125	130	150	180	200	250
AISI 304-304	Ref.	4021847	4021848	4022492	4021850	4021851	4021852	4021853	4021854
	€ U.	132,80	138,45	146,55	159,95	164,85	196,30	219,10	239,75
AISI 316L-304	Ref.	4020059**	4020060**	4022493	4020061	4020062	4020063	4020064	4020065
	€ U.	146,15	152,25	161,10	175,95	181,35	216,00	241,00	263,65

Medidas | Measurements | Mesures

L	238	271	295	295	315	345	365	445
ØT	80	100	130	130	150	180	200	250

### Codo de inspección | Inspection elbow | Coude d'inspection 87° \*



		ØDi mm							
		80	100	125	130	150	180	200	250
AISI 304-304	Ref.	4023726	4023728	4023729	4023731	4023732	4023735	4023736	4023737
	€ U.	249,80	272,00	286,15	294,75	301,45	361,60	385,10	437,85
AISI 316L-304	Ref.	4019914**	4019915**	4020163	4019917	4019918	4019919	4019920	4019921
	€ U.	282,45	304,70	320,45	330,10	337,55	405,05	431,35	490,40

Medidas | Measurements | Mesures

H	141	154	171	171	183	201	214	244
V	192	205	223	223	236	255	268	300
ØT	80	100	130	130	150	180	200	250

### Tapa de inspección | Inspection cover | Trappe d'inspection 200°C / 200 Pa



Resistente a condensados  
Condensate-resistant  
Résistante aux condensats

		ØDi mm										
		80	100	125	130	150	180	200	250	300	350	650
AISI 304	Ref.	5003265	5003266	5003267	5003267	5003268	5003269	5003270	5003271	5003272	5003270	
	€ U.	25,75	26,20	30,70	30,70	33,85	44,50	48,15	70,75	97,45	48,15	

Medidas | Measurements | Mesures

ØT	80	100	130	130	150	180	200	250	300	200
----	----	-----	-----	-----	-----	-----	-----	-----	-----	-----

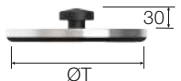

### Tapa condensación | Condensate cap | Tampon récupérateur condensats



		ØDi mm							
		80	100	125	130	150	180	200	250
AISI 316L-304	Ref.	4019962	4019963	4022046	4019965	4019966	4019967	4019968	4019969
	€ U.	132,35	135,15	140,40	140,90	155,05	164,30	166,05	179,70

Medidas | Measurements | Mesures

ØG	1/2"	1/2"	1/2"	1/2"	1/2"	3/4"	3/4"	3/4"
----	------	------	------	------	------	------	------	------

### Tubo recortable | Cut-out piping | Élément recoupable

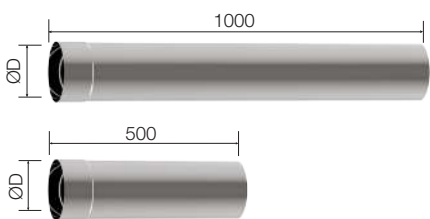

		1000 mm, 500 mm							
		ØDi mm							
		80	100	125	130	150	180	200	250
		<b>L 1000 mm</b>							
AISI 304	Ref.	4019895	4019896	4019897	4019897	4019898	4019899	4019900	4019901
	€ U.	48,45	52,85	68,85	68,85	74,05	90,05	100,10	126,35
		<b>L 500 mm</b>							
AISI 304	Ref.	4019885	4019886	4019887	4019887	4019888	4019889	4019890	4019891
	€ U.	35,90	37,75	41,00	41,00	44,00	52,20	54,85	77,65

### Base inicial con salida lateral | Floor base with lateral outlet | Plaque de départ avec sortie latérale



		ØDi mm							
		80	100	125	130	150	180	200	250
AISI 304	Ref.	4021875	4021876	4019971	4019971	4019973	4019974	4019975	4019977
	€ U.	69,15	76,10	90,45	90,45	96,55	104,65	112,85	128,10

### Regulador de tiro | Draft regulator | Modérateur de tirage

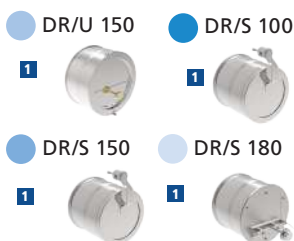

		ØD mm							
		80	100	125	130	150	180	200	250
		<b>DR/U 150</b>							
AISI 304	Ref.	-	-	-	4025728	4025729	4025730	-	-
	€ U.	-	-	-	181,85	189,60	215,30	-	-
		<b>DR/S 100</b>			<b>DR/S 150</b>		<b>DR/S 180</b>		
AISI 304	Ref.	4025731	4025732	4025733	4025734	4025735	4025736	4025737	4025738
	€ U.	234,10	238,95	260,25	294,75	320,85	482,45	491,30	511,60



Ref.	4021851	Unidades de embalaje Packing units Unités d'emballage
€ U.	164,85	1



Abrazadera de unión incluida en todas las piezas.  
Connection bracket included in all parts.  
Collier de fixation inclus dans toutes les pièces.



Junta incluida.  
Gasket included.  
Joint inclus.

\*\* ø80 - 100

300	350	400	450	500	550	600	650
4021855	4021856	4040308	4040315	4040316	4040317	4040318	4040319
413,05	465,45	594,95	741,45	842,05	970,20	1.087,25	1.233,15
4020066	4020067	4029473	4029536	4029659	4029772	4029980	4030079
454,35	512,00	654,40	815,45	926,20	1.067,10	1.195,95	1.356,45

465	441	435	405	405	405	405	405
300	200	200	200	200	200	200	200

300	350	400	450	500	550	600	650
4023738	4023739	-	-	-	-	-	-
677,25	867,30	-	-	-	-	-	-
4019922	4022032	4033088	4033091	4033092	4033093	4033094	4033095
758,45	974,30	998,35	1.248,90	1.419,45	1.619,45	1.850,45	2.057,60

275	307	563	587	611	634	658	682
333	366	624	649	674	699	724	749
300	200	200	200	200	200	200	200

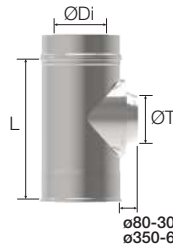

\* No incluye tapa  
Cover not included  
Couvercle non inclus

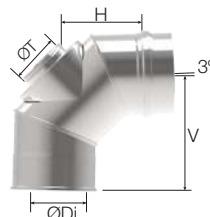

\* No incluye tapa  
Cover not included  
Couvercle non inclus

Tapa de inspección | Inspection cover | *Trappe d'inspection* 450°C / 40 Pa



Para combustibles sólidos  
For solid fuels  
Pour combustibles solides

AISI 304	Ref.	ØDi mm									
		80	100	125	130	150	180	200	250	300	350 - 650
€ U.	5003391	5003392	5003393	5003393	5003394	5003395	5003396	5003397	5003398	5003396	
	36,05	41,60	47,10	47,10	52,60	60,45	66,75	98,90	125,70	66,75	
Medidas   Measurements   Mesures		ØT									
		80	100	130	130	150	180	200	250	300	200

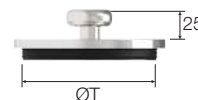

300	350	400	450	500	550	600	650
4019970	4023751	4029492	4029541	4029667	4029785	4030006	4030092
211,60	223,70	238,70	344,95	363,90	386,70	439,65	495,70

1"	1"	1"	1"	1"	1"	1"	1"
----	----	----	----	----	----	----	----



Alternativas de montaje de la base inicial | Alternative floor base mounting  
Possibilités de montage de la plaque de départ au sol

Montaje | Mounting | *Montage 1*

Con tubo recortable | With cut-out piping | *Avec tuyau recoupable*

El tubo recortable puede ser cortado a medida para que encaje perfectamente entre el suelo y la te de conexión a la caldera.  
The cutout tube can be cut to fit perfectly between the floor and connection "T" Piece to boiler.

L'élément recoupable peut être coupé sur mesure pour s'emboîter parfaitement entre le sol et le té de raccordement à la chaudière.

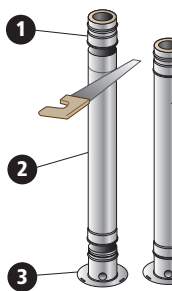

Montaje | Mounting | *Montage 2*

Sin tubo recortable  
Without cut-out piping  
Sans élément recoupable

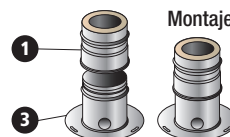

300	350	400	450	500	550	600	650
4019978	4022033	4028612	4040412	4040413	4040414	4040415	4040416
146,45	166,30	242,10	293,90	355,20	423,50	499,45	605,60

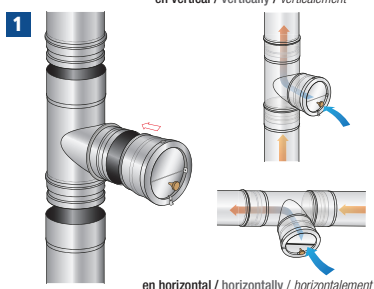
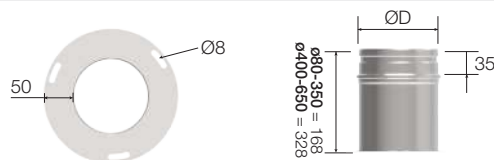

Montaje del Regulador de tiro  
Draft regulator assembly  
*Montage du Modérateur de tirage*

Montado en una Te de 90°. Vea la ilustración  
Mounted on a 90° "T" Piece. See the image  
*Se monte sur un Té 90°. Voir illustration.*

Módulo analizador de gas | Gas inspection module | *Module d'inspection de gaz*



		ØDi mm							
		80	100	125	130	150	180	200	250
AISI 316L-304	Ref.	4013601	4015574	4016672	4016673	4014513	4016674	4012118	4014514
	€ U.	125,80	130,10	135,20	138,20	150,60	170,20	191,70	225,10

Módulo analizador de gas y temperatura | Gas and temperature inspection module | *Module d'inspection de gaz et temperature \**



		ØDi mm							
		80	100	125	130	150	180	200	250
AISI 316L-304	Ref.	4017203	4017204	4017205	4017207	4017209	4017210	4017211	4017212
	€ U.	382,75	396,25	411,75	425,20	436,00	503,40	524,30	584,00

\* Pirómetro incluido | Pyrometer included | *Pyromètre inclus*

Módulo medio ambiente | Environment module | *Module d'environnement*



		ØDi mm							
		80	100	125	130	150	180	200	250
AISI 316L-304	Ref.	-	-	-	-	-	-	-	-
	€ U.	-	-	-	-	-	-	-	-

Paso mural extensible | Extendable wall bushing | *Traversée de mur télescopique*



		ØDi mm							
		80	100	125	130	150	180	200	250
AISI 304-304	Ref.	4021950	4021951	4021949	4021952	4021953	4021954	4021955	4021956
	€ U.	107,45	120,10	126,05	133,20	141,75	157,10	169,55	198,85
AISI 316L-304	Ref.	4019903	4019906	4019907	4019908	4019909	4019910	4019911	4019912
	€ U.	128,90	142,10	157,00	163,65	170,05	188,40	198,80	238,70

Paso mural | Wall bushing | *Traversée de mur*



		ØDi mm							
		80	100	125	130	150	180	200	250
AISI 304-304	Ref.	-	-	-	4021941	4021943	4021944	4021946	4021947
	€ U.	-	-	-	96,05	101,45	107,00	113,70	130,25
AISI 316L-304	Ref.	-	-	-	4020705	4020706	4020708	4020709	4020710
	€ U.	-	-	-	102,20	104,70	111,95	127,20	142,85

Paso forjado | Ceiling bushing | *Traversée d'étage* 1000 mm, 500 mm



L 1000 mm

		ØDi mm							
		80	100	125	130	150	180	200	250
AISI 316L-304	Ref.	4036001	4036002	4036003	4036004	4036005	4036006	4036007	4036008
	€ U.	133,80	158,60	181,30	189,05	199,20	224,45	241,40	314,65

Soporte forjado DP - DP | DW - DW ceiling support | *Plaque plancher DP - DP*



		ØDi mm							
		80	100	125	130	150	180	200	250
AISI 304-304	Ref.	4009218	2700961	4013901	2700962	2700963	2700964	2700965	2700966
	€ U.	100,40	107,55	114,95	116,30	116,60	136,95	140,60	174,00
AISI 316L-304	Ref.	4016383**	4016384**	4016385	4016386	4014544	4016388	4014545	4014549
	€ U.	125,45	129,55	143,75	144,20	145,05	171,15	175,90	217,55

Medidas | Measurements | *Mesures*

□ A	330	350	375	380	400	430	450	500
-----	-----	-----	-----	-----	-----	-----	-----	-----

Soporte forjado DP - SP | DW - SW ceiling support | *Plaque plancher DP - SP*



		ØDi mm							
		80	100	125	130	150	180	200	250
AISI 304-304	Ref.	4015126	4015127	4015128	4015129	4015130	4010338	4015131	4015132
	€ U.	95,75	97,60	108,20	108,70	109,35	128,90	132,45	163,85
AISI 316L-304	Ref.	4016387**	4016389**	4016390	4016258	4016416	4016417	4016418	4016419
	€ U.	119,70	122,00	135,35	135,80	136,60	161,10	165,55	204,75

Medidas | Measurements | *Mesures*

□ A	330	350	375	380	400	430	450	500
-----	-----	-----	-----	-----	-----	-----	-----	-----

Ref.	4017209	Unidades de embalaje Packing units Unités d'emballage
€ U.	436,00 1	



Abrazadera de unión incluida en todas las piezas.  
Connection bracket included in all parts.  
Collier de fixation inclus dans toutes les pièces.



Junta incluida.  
Gasket included.  
Joint inclus.

\*\* Ø80 - 100

300	350	400	450	500	550	600	650
4016676	4014401	4040324	4040331	4040332	4040333	4040334	4040335
275,80 1	337,60 1	450,05 1	488,55 1	533,10 1	555,50 1	581,45 1	755,40 1

300	350	400	450	500	550	600	650
4017213	4017214	4040411	4040341	4040342	4040343	4040344	4040345
618,65 1	699,05 1	764,95 1	802,50 1	847,05 1	886,50 1	938,50 1	1.036,30 1

300	350	400	450	500	550	600	650
-	4040280	4040281	4040282	4040283	4040284	4040285	4040286
-	1.416,55 1	1.523,55 1	1.580,90 1	1.639,45 1	1.772,80 1	1.882,55 1	2.021,90 1

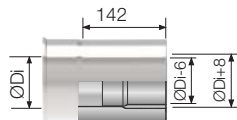
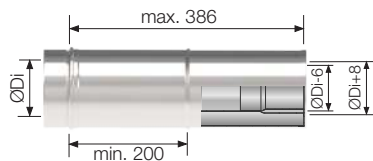
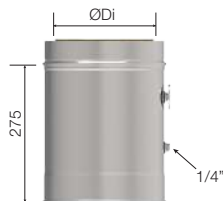
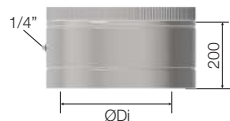

Pirómetro | Pyrometer | Pyromètre

Ref.	2500297
€ U.	31,60 1

0-500°C

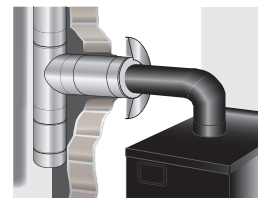
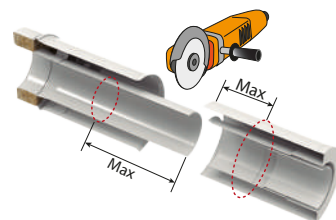

L 500 mm

		ØDi mm							
AISI	Ref.	80	100	125	130	150	180	200	250
316L-304	€ U.	76,90 1	91,10 1	101,30 1	107,95 1	112,60 1	126,85 1	136,45 1	176,85 1

300	350
2700833	4009285
218,85 1	259,45 1
4016391	4016392
312,85 1	350,30 1

550	600
-----	-----

300	350
4015133	4015134
190,25 1	225,65 1
4016420	4016421
256,90 1	304,55 1

550	600
-----	-----

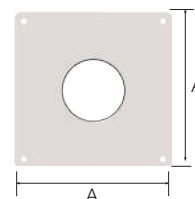
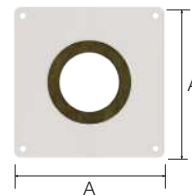

### Sombrero antilluvia | Rain cap | *Chapeau pare-pluie*



\*Opción antipájaros  
\*Bird guard option  
\*Option anti-volatile

		ØDi mm							
		80	100	125	130	150	180	200	250
AISI 304-304	Ref.	2700625	2700023	4013722	2700106	2700174	2700228	2700277	2700336
	€ U.	51,55	54,80	61,25	62,05	62,85	80,55	85,80	107,20
AISI 316L-304	Ref.	4700595**	4700596**	4016435	4016436	4008380	4015399	4012122	4014558
	€ U.	67,00	72,85	79,55	80,60	81,75	104,60	111,30	134,40
AISI 316L-304*	Ref.	4016150**	4016151**	4016152	4016153	4016154	4016155	4016156	4016157
	€ U.	86,80	92,55	100,80	102,30	105,15	130,60	139,05	166,40

#### Medidas | Measurements | Mesures

	V	103	103	103	103	103	103	103	141
	ØDs	250	250	300	300	300	350	350	450

### Sombrero antiretorno | Non-return cap | *Chapeau anti-refoulement*



		ØDi mm							
		80	100	125	130	150	180	200	250
AISI 304-304	Ref.	2700626	2700024	4013723	2700107	2700175	2700229	2700278	2700337
	€ U.	84,65	94,95	101,25	107,30	121,25	136,80	148,00	187,55
AISI 316L-304	Ref.	4600592**	4600593**	4016448	4016449	4014559	4016450	4014560	4014561
	€ U.	93,55	113,80	121,40	128,70	145,45	164,15	177,50	225,05

#### Medidas | Measurements | Mesures

	V	265	265	265	265	265	265	323	323
	U	142	142	142	142	142	142	200	200
	ØDs	180	200	230	230	250	280	350	400

### Sombrero giratorio | Wind directional cap | *Chapeau aspirateur*



		ØDi mm							
		80	100	125	130	150	180	200	250
AISI 304-304	Ref.	-	-	4013729	2700872	2700873	2700874	2700875	2700887
	€ U.	-	-	276,80	280,40	312,70	346,20	383,65	421,70

#### Medidas | Measurements | Mesures

	V	-	-	415	415	435	435	485	485
	ØDs	-	-	175	175	205	205	250	250

### Sombrero salida libre | Exhaust high cone | *Cône de finition haute*



		ØDi mm							
		80	100	125	130	150	180	200	250
AISI 304-304	Ref.	4015140	2700025	4013731	2700108	2700176	2700230	2700279	2700338
	€ U.	55,00	60,70	68,75	74,50	82,80	96,85	110,15	145,45
AISI 316L-304	Ref.	4600590**	4600591**	4016460	4016461	4014556	4016462	4014391	4014562
	€ U.	60,55	66,75	75,60	82,00	91,10	106,60	121,25	159,95

### Sombrero terminal sencillo | Simple cap | *Chapeau finition haute*



		ØDi mm									
		80	100	125	130	150	180	200	250	300	350
AISI 304-304	Ref.	4012223	4015141	4013732	2700112	2700180	2700234	2700286	2700346	2700860	2700975
	€ U.	47,90	52,85	59,90	64,80	72,05	84,25	95,85	126,55	169,75	210,15
AISI 316L-304	Ref.	4016487**	4016488**	4016489	4016490	4016491	4016492	4016493	4016494	4016495	4016497
	€ U.	53,95	59,45	67,35	72,95	81,15	94,95	107,90	142,40	190,95	231,10



### Sombrero lamas | Simple cap | *Chapeau finition haute*



		ØDi mm							
		80	100	125	130	150	180	200	250
AISI 304-304	Ref.	4034080	4034100	4034125	4034130	4034150	4034180	4034200	4034250
	€ U.	177,15	196,85	218,70	243,00	270,00	298,70	377,60	458,90

#### Medidas | Measurements | Mesures

	L	160	160	160	160	190	190	220	250
--	---	-----	-----	-----	-----	-----	-----	-----	-----

### Sombrero pico flauta | Flute peak cap | *Chapeau de flûte*



		ØDi mm							
		80	100	125	130	150	180	200	250
AISI 316L-304	Ref.	4014044**	4009839**	4013730	4007530	4008294	4008296	4008895	4011343
	€ U.	87,45	97,80	106,60	108,05	123,35	138,20	142,15	156,55

#### Medidas | Measurements | Mesures

	L	105	105	105	105	105	105	105	105
--	---	-----	-----	-----	-----	-----	-----	-----	-----

Ref.	2700175	Unidades de embalaje Packing units Unités d'emballage
€ U.	121,25 1	



Abrazadera de unión incluida en todas las piezas.  
Connection bracket included in all parts.  
Collier de fixation inclus dans toutes les pièces.



Junta incluida.  
Gasket included.  
Joint inclus.

\*\* ø80 - 100

300	350	400	450	500	550	600	650
2700392	2700879	4009184	4040361	4040002	4040362	4040363	4040364
177,90 1	220,45 1	299,45 1	344,60 1	413,10 1	501,65 1	596,90 1	704,10 1
4016437	4016438	4029483	4029537	4029660	4029773	4029981	4030080
231,25 1	286,55 1	365,25 1	441,10 1	528,70 1	642,15 1	765,25 1	901,20 1
4016158	-	-	-	-	-	-	-
267,50 1	-	-	-	-	-	-	-

141	141	151	151	200	200	200	300
500	550	600	650	700	750	800	850

300	350	400	450	500	550	600	650
2700832	2700881	4040423	4040365	4040366	4040367	4040368	4040369
213,00 1	331,40 1	419,15 1	482,45 1	578,30 1	759,85 1	852,00 1	988,65 1
4016451	4016452	4040424	4040370	4040371	4040372	4040373	4040374
255,65 1	345,80 1	511,45 1	578,90 1	682,40 1	814,60 1	952,60 1	1.105,30 1

323	323	635	635	635	635	635	635
200	200	500	500	500	500	500	500
450	500	600	650	700	750	800	850

300	350
2700888	2700889
520,40 1	671,20 1

505	575
260	290

300	350	400	450	500	550	600	650
2700393	2700428	4012752	4040375	4040376	4040377	4040378	4040379
195,15 1	241,50 1	258,95 1	274,65 1	334,65 1	405,05 1	544,60 1	644,65 1
4013920	4012513	4029485	4012663	4029662	4029775	4029983	4030082
214,60 1	259,55 1	278,40 1	302,15 1	359,80 1	435,40 1	585,40 1	693,00 1

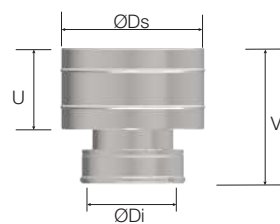
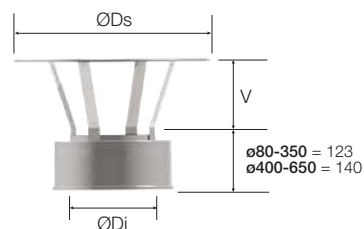

Sombrero salida vertical | Vertical outlet cap | Chapeau sortie verticale



		ØDi mm	80	100	125	130	150	180	200	250	300	350
AISI 304-304	Ref.		4014650	4014651	4014652	4014653	2700655	2700654	2700653	2700661	4007347	4014654
	€ U.		141,05 1	156,75 1	170,90 1	181,25 1	196,70 1	225,20 1	252,35 1	284,75 1	327,45 1	355,90 1
AISI 316L-304	Ref.		4014655**	4014656**	4014657	4014658	4014597	4014659	4014598	4014599	4014660	4014661
	€ U.		160,35 1	178,00 1	193,65 1	205,90 1	223,55 1	255,85 1	286,80 1	323,50 1	372,05 1	404,30 1



300	350
4034300	4034350
523,45 1	689,20 1

250	280
-----	-----

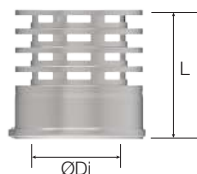

300	350	400	450	500	550	600	650
4007465	4007903	4007904	4007905	4007906	4007907	4007908	4007909
222,20 1	239,10 1	278,00 1	350,80 1	386,95 1	499,85 1	553,40 1	620,40 1

105	105	180	180	180	180	180	180
-----	-----	-----	-----	-----	-----	-----	-----

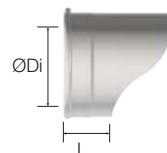

Adaptador caldera exterior | Exterior boiler adapter | *Adaptateur chaudière extérieure*



		ØDi mm							
		80	100	125	130	150	180	200	250
AISI <b>304-304</b>	Ref.	4007628	2700011	4013903	2700084	2700152	2700210	2700259	2700319
	€ U.	<b>40,00</b>	<b>46,95</b>	<b>53,25</b>	<b>54,25</b>	<b>57,60</b>	<b>67,80</b>	<b>74,60</b>	<b>84,90</b>
AISI <b>316L-304</b>	Ref.	4600550	4015572	4016619	4015054	4014557	4016620	4014606	4014607
	€ U.	<b>50,75</b>	<b>61,05</b>	<b>69,20</b>	<b>70,60</b>	<b>75,00</b>	<b>88,15</b>	<b>97,20</b>	<b>110,30</b>

Adaptador caldera interior | Interior boiler adapter | *Adaptateur chaudière intérieure*



		ØDi mm							
		80	100	125	130	150	180	200	250
AISI <b>316L-304</b>	Ref.	4027040	4027041	4027043	4027044	4027045	4027046	4027048	4027049
	€ U.	<b>50,75</b>	<b>61,05</b>	<b>69,20</b>	<b>70,60</b>	<b>75,00</b>	<b>88,15</b>	<b>97,20</b>	<b>110,30</b>

Adaptador caldera antihollín | Anti-soot boiler adapter | *Adaptateur chaudière anti-bistre*



		ØDi mm							
		80	100	125	130	150	180	200	250
AISI <b>316L-304</b>	Ref.	-	4025410	4025411	4025412	4025413	4025414	4025415	4025416
	€ U.	-	<b>66,85</b>	<b>73,45</b>	<b>73,60</b>	<b>77,70</b>	<b>96,20</b>	<b>100,95</b>	<b>115,80</b>

Adaptador DP - SP | DW - SW Adapter | *Adaptateur DP - SP*



		ØDi mm							
		80	100	125	130	150	180	200	250
AISI <b>304-304</b>	Ref.	4010098	4008853	4013798	2700090	2700158	2700211	2700260	2700320
	€ U.	<b>36,80</b>	<b>38,40</b>	<b>45,60</b>	<b>46,15</b>	<b>50,05</b>	<b>62,40</b>	<b>66,10</b>	<b>83,15</b>
AISI <b>316L-304</b>	Ref.	4015108	4016622	4016623	4015055	4014570	4016624	4014580	4014571
	€ U.	<b>47,30</b>	<b>53,30</b>	<b>62,20</b>	<b>63,10</b>	<b>70,20</b>	<b>84,75</b>	<b>90,40</b>	<b>105,45</b>

Medidas | Measurements | Mesures

L	160	160	160	160	160	160	160	160	160
---	-----	-----	-----	-----	-----	-----	-----	-----	-----

Adaptador fumistería a DP | Connecting flue pipe - DW Adapter | *Adaptateur fumisterie - DP*



		ØDi mm							
		80	100	125	125	130	150	180	200
AISI <b>316L-304</b>	Ref.	4040908	4040910	4040911	4040912	4040913	4040915	4040918	4040921
	€ U.	<b>58,85</b>	<b>64,75</b>	<b>74,60</b>	<b>74,60</b>	<b>75,45</b>	<b>83,85</b>	<b>90,60</b>	<b>92,00</b>

Medidas | Measurements | Mesures

ØDf	80	100	120	125	130	150	175	200
-----	----	-----	-----	-----	-----	-----	-----	-----

Adaptador pestaña SP - DP | SW Lip - DW Adapter | *Adaptateur bord tombé SP - DP*



		ØDi mm							
		80	100	125	130	150	180	200	250
AISI <b>316L-304</b>	Ref.	4040660	4040661	4040662	4040663	4040664	4040665	4040666	4040667
	€ U.	<b>47,55</b>	<b>52,35</b>	<b>60,25</b>	<b>60,95</b>	<b>67,75</b>	<b>98,40</b>	<b>86,20</b>	<b>121,75</b>

Adaptador DP - pestaña SP | DW - SW Lip Adapter | *Adaptateur DP - bord tombé SP*



		ØDi mm							
		80	100	125	130	150	180	200	250
AISI <b>316L-304</b>	Ref.	4040680	4040681	4040682	4040683	4040684	4040685	4040686	4040687
	€ U.	<b>47,55</b>	<b>52,35</b>	<b>60,25</b>	<b>60,95</b>	<b>67,75</b>	<b>79,55</b>	<b>86,20</b>	<b>121,75</b>

Ref.	2700152	Unidades de embalaje Packing units Unités d'emballage
€ U.	57,60 <sup>1</sup>	



Abrazadera de unión incluida en todas las piezas.  
Connection bracket included in all parts.  
Collier de fixation inclus dans tous les pièces.

1

300	350	400	450	500	550	600	650
2700822	2700877	2500067	4033051	4033052	4033054	4033055	4033056
119,75 <sup>1</sup>	155,85 <sup>1</sup>	172,45 <sup>1</sup>	187,05 <sup>1</sup>	197,85 <sup>1</sup>	221,15 <sup>1</sup>	240,10 <sup>1</sup>	263,75 <sup>1</sup>
4009454	4016621	4029520	4029521	4029650	4029752	4029964	4030071
155,75 <sup>1</sup>	202,60 <sup>1</sup>	224,10 <sup>1</sup>	231,05 <sup>1</sup>	251,25 <sup>1</sup>	276,35 <sup>1</sup>	300,10 <sup>1</sup>	323,10 <sup>1</sup>

300	350
4027050	4027051
135,75 <sup>1</sup>	191,05 <sup>1</sup>

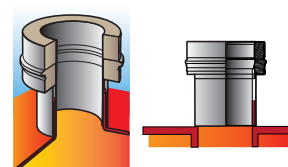
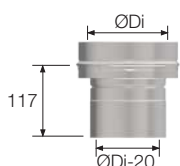
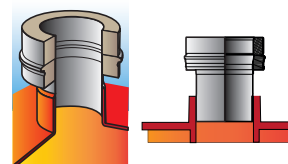
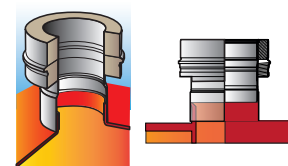

300	350	400	450	500	550	600	650
2700823	2700876	4033500	4033501	4033502	4033503	4033504	4033505
132,15 <sup>1</sup>	161,25 <sup>1</sup>	174,60 <sup>1</sup>	193,65 <sup>1</sup>	222,55 <sup>1</sup>	277,40 <sup>1</sup>	332,30 <sup>1</sup>	382,80 <sup>1</sup>
4015040	4016625	4033273	4033490	4033491	4033494	4033495	4033496
167,80 <sup>1</sup>	204,70 <sup>1</sup>	221,75 <sup>1</sup>	237,10 <sup>1</sup>	273,80 <sup>1</sup>	323,15 <sup>1</sup>	381,00 <sup>1</sup>	426,15 <sup>1</sup>

160	160	240	240	240	240	240	240
-----	-----	-----	-----	-----	-----	-----	-----

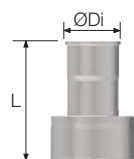

250	300	350
4040925	4040930	4040935
121,80 <sup>1</sup>	185,45 <sup>1</sup>	224,35 <sup>1</sup>

250	300	350
-----	-----	-----

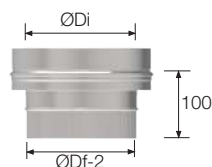

300	350	400	450	500	550	600	650
4040668	4040669	4040670	4040671	4040672	4040673	4040674	4040675
185,45 <sup>1</sup>	181,40 <sup>1</sup>	195,10 <sup>1</sup>	210,20 <sup>1</sup>	239,90 <sup>1</sup>	287,20 <sup>1</sup>	337,15 <sup>1</sup>	378,95 <sup>1</sup>

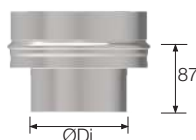

300	350	400	450	500	550	600	650
4040688	4040689	4040690	4040691	4040692	4040693	4040694	4040695
149,95 <sup>1</sup>	181,40 <sup>1</sup>	241,20 <sup>1</sup>	210,20 <sup>1</sup>	239,90 <sup>1</sup>	287,20 <sup>1</sup>	337,15 <sup>1</sup>	378,95 <sup>1</sup>

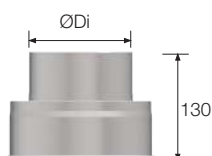

# DP

Ø80-650

## Doble Pared | Double Wall | Double Paroi

Aumento Augmentation adapter Augmentation				Reducción Reduction Adapter Réduction			
ø	80	100	125	ø	80	100	125
80		402281** 238,80	402282 232,10	80		402286** 208,80	402287** 217,10
100	402280 205,15		402283 233,80	100	402290 193,15		402291** 233,80
125	402284 217,20	402285 221,25		125	402293 217,20	402294 221,25	

Aumento · Reducción | Augmentation Adapter · Reduction Adapter | Augmentation · Réduction

Ø	80	100	125	130	150	180	200	250	300	350	400	450	500	550	600	650
80		4022715** <b>173,90</b>	4022718 <b>193,45</b>	4022723 <b>194,55</b>												
	4022652** <b>170,95</b>		4022717 <b>194,95</b>	4022721 <b>199,45</b>	4022731 <b>205,35</b>											
100	4022669 <b>181,00</b>	4022677 <b>184,40</b>		4022720 <b>204,75</b>	4022727 <b>206,25</b>	4022739 <b>209,65</b>	4022743 <b>236,15</b>									
	4022672 <b>182,40</b>	4022679 <b>194,55</b>	4022684 <b>198,50</b>		4022725 <b>207,10</b>	4022735 <b>215,45</b>	4022742 <b>238,55</b>									
125	4022675 <b>183,80</b>	4022682 <b>196,90</b>	4019995 <b>201,85</b>	4022690 <b>204,30</b>		4022733 <b>224,55</b>	4022741 <b>244,70</b>	4022746 <b>272,70</b>								
			4022688 <b>208,10</b>	4022691 <b>209,25</b>	4022693 <b>225,80</b>		4022740 <b>256,50</b>	4022745 <b>275,65</b>								
130			4022689 <b>212,20</b>	4022692 <b>212,95</b>	4022695 <b>228,65</b>	4022698 <b>232,05</b>		4022744 <b>278,60</b>	4022749 <b>299,15</b>	4040821 <b>360,05</b>						
					4022696 <b>232,55</b>	4012123 <b>248,80</b>	4022702 <b>253,20</b>		4022747 <b>309,35</b>	4022751 <b>364,45</b>	4040822 <b>445,50</b>					
150					4014704 <b>251,15</b>	4022701 <b>264,05</b>	4022705 <b>284,55</b>	4022709 <b>298,35</b>		4022750 <b>369,00</b>	4040823 <b>450,90</b>	4040824 <b>671,15</b>				
							4022707 <b>339,50</b>	4022711 <b>345,35</b>	4022713 <b>353,85</b>		4040825 <b>463,45</b>	4040826 <b>648,80</b>	4040827 <b>749,20</b>			
200									4040858 <b>420,00</b>	4040859 <b>452,65</b>		4040828 <b>631,85</b>	4040829 <b>733,05</b>	4040830 <b>894,00</b>		
									4040860 <b>567,70</b>	4040861 <b>594,45</b>	4040862 <b>601,85</b>		4040831 <b>716,50</b>	4040832 <b>853,80</b>	4040833 <b>1.091,15</b>	
250										4040863 <b>735,85</b>	4040864 <b>751,60</b>	4040865 <b>764,05</b>		4040834 <b>776,10</b>	4040835 <b>1.048,50</b>	4040836 <b>1.425,75</b>
											4040866 <b>831,70</b>	4040867 <b>794,20</b>	4040868 <b>721,90</b>		4040837 <b>949,60</b>	4040838 <b>1.360,50</b>
300												4040869 <b>1.015,05</b>	4040870 <b>972,45</b>	4040871 <b>883,30</b>		4040839 <b>1.236,90</b>
													4040872 <b>1.326,25</b>	4040873 <b>1.265,55</b>	4040874 <b>1.150,60</b>	

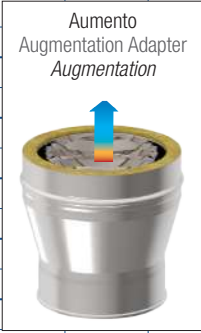
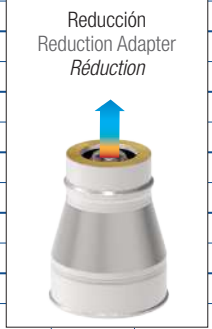

L mm	øDi mm															
	80	100	125	130	150	180	200	250	300	350	400	450	500	550	600	650
80		140	192	192												
100	140		155	155	192											
125	202	155		118	140	197	234									
130	192	155	118		140	197	234									
150	230	192	141	141		159	196	289								
180			197	197	159		141	233								
200			234	234	196	141		196	289	383						
250					290	233	196		204	291	203					
300					383	327	290	204		196	178	203				
350							383	291	196		153	179	203			
400									171	145		147	172	198		
450									195	171	147		146	172	197	
500									195	172	146		147	172	197	
550										198	172	146		146	173	
600											197	172	146		146	
650												197	172	146		

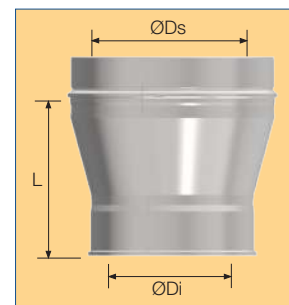





Abrazadera de unión incluida en todas las piezas.  
Connection bracket included in all parts.  
Collier de fixation inclus dans toutes les pièces.



Junta incluida.  
Gasket included.  
Joint inclus. **\*\* ø80 - 100**

Material: | Material: | Matériel : **AISI 316L - 304**

Unidades de embalaje: | Packing units: | Unités d'emballage : **1**

**Aumento y Reducción excéntrica | Eccentric augmentation adapter and reduction adapter | Augmentation et réduction excentrées**

**1**

Ø	80	100	125	130	150	180	200	250	300	350	400	450	500	550	600	650
80		4029368**	4029369	4029370												
		<b>208,80</b>	<b>232,10</b>	<b>233,45</b>												
100	4029300**		4029371	4029372	4029373											
	<b>205,15</b>		<b>233,80</b>	<b>239,40</b>	<b>246,45</b>											
125	4029303	4029304			4029378	4029379	4029380									
	<b>217,20</b>	<b>221,25</b>			<b>247,45</b>	<b>251,65</b>	<b>283,30</b>									
130	4029305	4029306			4029381	4029382	4029383									
	<b>218,90</b>	<b>233,45</b>			<b>248,60</b>	<b>258,45</b>	<b>286,15</b>									
150	4029340	4029341	4029342	4029343		4029384	4029385	4029386								
	<b>220,50</b>	<b>236,35</b>	<b>242,20</b>	<b>245,05</b>		<b>269,45</b>	<b>293,55</b>	<b>327,25</b>								
180			4029344	4029345	4029346		4029389	4029390								
			<b>249,70</b>	<b>251,05</b>	<b>270,85</b>		<b>307,75</b>	<b>330,70</b>								
200			4029947	4029348	4029349	4029355		4029391	4029393	4029951						
			<b>254,75</b>	<b>255,55</b>	<b>274,45</b>	<b>278,40</b>		<b>334,35</b>	<b>358,90</b>	<b>432,05</b>						
250					4029356	4029357	4029358		4029394	4029396	4040840					
					<b>279,05</b>	<b>298,55</b>	<b>303,80</b>		<b>371,15</b>	<b>437,30</b>	<b>534,55</b>					
300					4029359	4029361	4029362	4029363		4029397	4040841	4040842				
					<b>301,45</b>	<b>316,80</b>	<b>341,35</b>	<b>358,00</b>		<b>442,75</b>	<b>541,20</b>	<b>805,35</b>				
350						4029364	4029365	4029366		4040843	4040844	4040845				
						<b>407,35</b>	<b>414,45</b>	<b>424,60</b>		<b>556,10</b>	<b>778,55</b>	<b>899,00</b>				
400									4040887	4040888		4040846	4040847	4040848		
									<b>503,95</b>	<b>543,15</b>		<b>758,25</b>	<b>879,55</b>	<b>1.071,90</b>		
450									4040889	4040890	4040876		4040849	4040850	4040851	
									<b>681,30</b>	<b>713,35</b>	<b>721,55</b>		<b>859,70</b>	<b>1.023,65</b>	<b>1.308,15</b>	
500										4040891	4040877	4040878		4040852	4040853	4040854
										<b>883,05</b>	<b>901,00</b>	<b>916,80</b>		<b>930,45</b>	<b>1.257,00</b>	<b>1.709,20</b>
550											4040879	4040880	4040881		4040855	4040856
											<b>997,00</b>	<b>952,20</b>	<b>865,45</b>		<b>1.138,35</b>	<b>1.631,05</b>
600												4040882	4040883	4040875		4040857
												<b>1.216,95</b>	<b>1.165,85</b>	<b>811,80</b>		<b>1.482,95</b>
650													4040884	4040885	4040886	
													<b>1.583,10</b>	<b>1.517,20</b>	<b>1.379,40</b>	

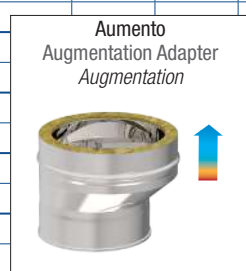

L mm	øDi mm															
	80	100	125	130	150	180	200	250	300	350	400	450	500	550	600	650
80		120	149	149												
100	124		127	127	144											
125	148	128			120	146	164									
130	150	132			120	146	164									
150	167	150	128	124		129	146	189								
180			152	148	131		120	163								
200			170	165	148	124		146	189	236						
250					191	167	150		146	189	248					
300					235	211	193	150		146	205	248				
350							236	193	150		162	205	248			
400									209	165		162	205	248		
450										252	209	165		162	205	248
500											252	209	165		162	205
550												252	209	165		162
600													252	209	165	162
650														252	209	165

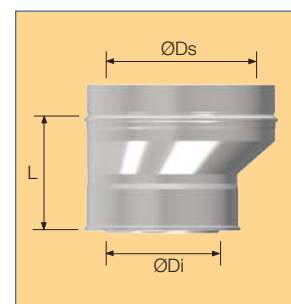
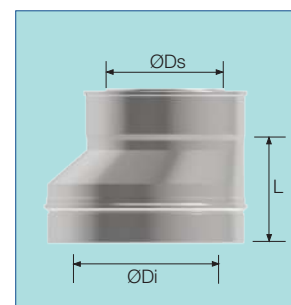

#### Abrazadera de unión clip | Pipe fast locking bracket | Collier de fixation à clip



		ØDi mm										
		80	100	125	130	150	180	200	250	300	350	
AISI 304	Ref.	5003962	5003976	5003977	5003977	5003978	5003988	5003979	5003981	5003982	5003983	
	€ U.	6,80 1	7,45 1	7,60 1	7,75 1	7,95 1	8,05 1	10,60 1	11,65 1	12,80 1	10,95 1	
		ØDe mm										
		130	150	180	180	200	230	250	300	350	400	

#### Junta silicona | Silicone gasket | Joint silicone



		ØDi mm										
		80	100	125	130	150	180	200	250	300	350	400
	Ref.	5003948	5003950	5003951	5003951	5003952	5003953	5003954	5003957	5003958	5003959	5003960
	€ U.	1,50 10	1,65 10	1,95 10	2,60 10	3,75 10	4,15 10	5,60 10	7,60 5	10,30 5	12,90 1	12,90 5

#### Junta Clase D | Class D gasket | Joint Classe D



		ØDi mm										
		80	100	125	130	150	180	200	250	300	350	400
	Ref.	-	-	-	-	-	-	-	5003921	5003922	5003923	5003924
	€ U.	-	-	-	-	-	-	-	9,40 5	10,15 5	16,90 1	22,50 5

#### Junta cerámica autoadhesiva | Self-adhesive ceramic gasket | Joint autoadhésif en céramique



		Medidas   Measurements   Mesures												
		Ref.		Øm										
		2053351		80	100	125	130	150	180	200				
	€ m.	3,50 1		0,25	0,31	0,39	0,41	0,47	0,57	0,63				
		m (desarrollo)												
				0,25	0,31	0,39	0,41	0,47	0,57	0,63				

Precio del metro lineal | Price per linear metre | Prix par mètre linéaire

#### Abrazadera mural exterior | External wall bracket | Collier support mural extérieur \*



Ø 80-300



Ø 350-650

		ØDi mm										
		80	100	125	130	150	180	200	250	300	350	400
AISI 304	Ref.	4019876	4019877	4019878	4019878	4019879	4019880	4019881	4019882			
	€ U.	53,50 1	54,10 1	58,95 1	58,95 1	60,90 1	67,55 1	70,25 1	109,70 1			
		ØDe mm										
		130	150	180	180	200	230	250	300	350	400	

#### Abrazadera mural interior | Interior wall bracket | Collier support mural intérieur \*



		ØDi mm												
		80	100	125	130	150	180	200	250	300	350	400		
AISI 304	Ref.	2500038	2500039	2500040	2500040	2500041	5001351	2500042	2500043	2500510	2500044	4035019		
	€ U.	13,90 6	14,75 6	15,90 6	15,90 6	17,75 6	24,10 2	25,60 2	32,85 2	44,95 2	63,60 2	104,00 1		
		Medidas   Measurements   Mesures												
		A		120	120	150	150	150	190	190	230	230	-	-
		ØDe mm												
		130	150	180	180	200	230	250	300	350	400	450		

#### Abrazadera pared regulable | Adjustable wall bracket | Collier mural réglable



		ØDi mm											
		80	100	125	130	150	180	200	250	300	350		
AISI 304	Ref.	4600707	4600703	4600705	4600705	4600704	4600708	4600706	4600709	4600710	4600711		
	€ U.	17,05 1	19,30 1	23,65 1	23,65 1	29,00 1	34,50 1	38,10 1	46,00 1	46,20 1	59,25 1		
		Medidas   Measurements   Mesures											
		A		186	186	226	226	226	266	266	336	336	
		ØDe mm											
		130	150	180	180	200	230	250	300	350	400		

#### Abrazadera de vientos | Roof brace band | Collier pour hauban



		ØDi mm										
		80	100	125	130	150	180	200	250	300	350	400
AISI 304	Ref.	2700121	2700190	2700241	2700241	2700295	2700214	2700354	2700403	2700323	2700418	4014608
	€ U.	30,35 3	31,60 3	37,70 3	37,70 3	39,80 3	40,75 1	49,15 1	67,75 1	75,25 1	85,70 1	95,20 1
		ØDe mm										
		130	150	180	180	200	230	250	300	350	400	450

#### Abrazadera vientos estática | Static roof brace band | Bride de haubanage statique



		ØDi mm										
		80	100	125	130	150	180	200	250	300	350	
AISI 304	Ref.	4020129	4020130	4020131	4020131	4020132	4020133	4020134	4020135	4020136	4020137	
	€ U.	62,00 1	62,55 1	66,10 1	66,10 1	68,55 1	74,65 1	77,30 1	84,00 1	103,30 1	115,05 1	
		Medidas   Measurements   Mesures										
		L		250	250	250	250	250	250	250	250	333
		ØDe mm										
		130	150	180	180	200	230	250	300	350	400	

Ref.	5003978	Unidades de embalaje Packing units Unités d'emballage
€ U.	7,75 1	

Abrazadera unión ancha | Wide connection bracket | Collier de fixation large

	ØDi mm	400	450	500	550	600	650	
	AISI 304	Ref.	5005567	5005568	5005569	5005570	5005571	5005572
	€ U.	20,95 1	23,10 1	24,95 1	26,65 1	28,80 1	30,95 1	
	ØDe mm	450	500	550	600	650	700	

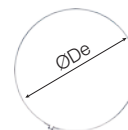

1

450	500	550	600	650
5005716	5005717	5005718	5005719	5005720
16,15 1	19,35 1	22,40 1	25,85 1	28,95 1

450	500	550	600	650
5003925	5003926	5003927	5003928	5003929
30,00 1	37,75 1	45,30 1	53,90 1	70,10 1

250	300	350
0,79	0,94	1,1

300	350	400	450	500	550	600	650
4020326	4020327	4031696	4031697	4031698	4031699	4031700	4031701
156,30 1	163,15 1	187,75 1	219,15 1	250,10 1	279,80 1	320,40 1	365,55 1
350	400	450	500	550	600	650	700

450	500	550	600	650
4035066	4035067	4035068	4035069	4035070
117,10 1	128,50 1	137,85 1	150,55 1	164,05 1

-	-	-	-	-
500	550	600	650	700

450	500	550	600	650
4014609	4014610	4014611	4014612	4014613
96,95 1	101,60 1	106,30 1	114,40 1	123,15 1
500	550	600	650	700

Lubricante silicona | Silicone lubricant | Graisse silicone



**150ml**

Ref.	5002932
€ U.	8,60 1

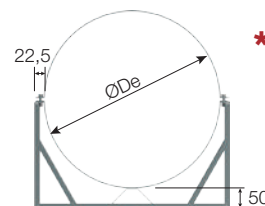
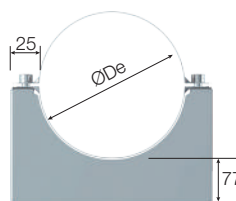

\* Opción regulable: añadir Prolongación mural (ver pág. 132)  
Adjustable option: add Wall extension (see page 132)  
Option réglable: ajouter Rallonge murale (voir page 132)

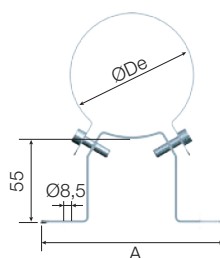

\* Opción regulable: añadir Prolongación mural (ver pág. 132)  
Adjustable option: add Wall extension (see page 132)  
Option réglable: ajouter Rallonge murale (voir page 132)

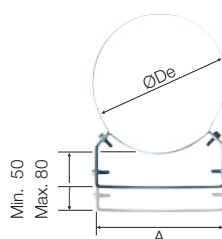

#### Abrazadera de suspensión horizontal | Horizontal suspension bracket | Collier de suspension horizontale



		ØDi mm									
		80	100	125	130	150	180	200	250	300	350
AISI 304	Ref.	-	-	-	5005630	5005631	5005632	5005633	5005634	5005635	5005636
	€ U.	-	-	-	13,50	13,90	14,10	14,20	17,10	19,80	22,30
		ØDe mm									
		-	-	-	180	200	230	250	300	350	400

\* No incluye varillas de fijación ni tornillería necesaria | Fixing rods and necessary screws not included |  
Tiges de fixation et vis nécessaires non incluses

#### Soporte mural intermedio | Intermediate wall support | Support mural intermédiaire \*



		ØDi mm									
		80	100	125	130	150	180	200	250	300	350
AISI 304-304	Ref.	-	-	-	-	-	-	-	-	-	-
	€ U.	-	-	-	-	-	-	-	-	-	-
AISI 316L-304	Ref.	4020107**	4020108**	4022061	4020109	4020110	4020111	4020112	4020113	4020114	4020115
	€ U.	117,65	123,05	143,15	146,90	153,90	166,35	202,40	206,65	234,55	261,70

Medidas | Measurements | Mesures

	A	165	185	210	215	235	263	283	333	383	433
B	245	265	290	295	315	343	363	413	463	513	

\* No incluye escuadras | Square supports not included | Équerres de support non inclus

#### Soporte mural universal | Universal wall support | Support mural universel \*

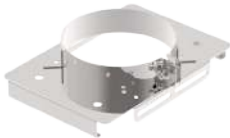

		ØDi mm									
		80	100	125	130	150	180	200	250	300	350
AISI 304	Ref.	4026049	4026050	4026051	4026051	4026052	4026053	4026054	4026059	4026060	4026061
	€ U.	81,40	86,10	93,70	93,70	101,75	111,00	119,20	145,75	168,85	189,40

Medidas | Measurements | Mesures

	A	165	185	213	213	233	263	283	333	383	435
B	245	265	293	293	313	343	363	413	463	515	

		ØDe mm									
		130	150	180	180	200	230	250	300	350	400

\* No incluye escuadras | Square supports not included | Équerres de support non inclus

#### Escuadra de soporte (2 unidades) | Square support (2 units) | Équerre de support (2 unités)



		Pequeña* Small* Petit*	Mediana* Medium* Moyen*	Grande* Large* Grand*
AISI 304	Ref.	4019925	4019926	4019927
	€ Kit	70,65	94,25	122,35

Medidas | Measurements | Mesures

	L	245	360	515
H	290	430	610	

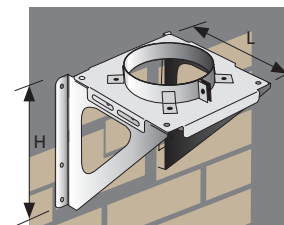

Escuadra con soporte mural  
Square with wall support  
Équerre avec support mural

\* Consultar el tamaño adecuado en la página 143.  
Refer to the appropriate size on page 143.  
Voir la taille appropriée à la page 143.

#### Escuadra de soporte reforzada (2 unidades) | Reinforced square support (2 units) | Équerre de support renforcé (2 unités)



		L		
		500 mm	750 mm	1000 mm
AISI 304	Ref.	5003914	5003915	5003916
	€ Kit	194,95	257,35	292,50

Medidas | Measurements | Mesures

	H	310	470	600
--	---	-----	-----	-----

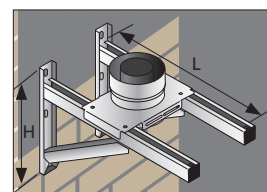

Escuadra reforzada con soporte mural  
Reinforced square with wall support  
Support renforcé avec support mural

\* Apta para Soporte mural universal e intermedio | Suitable for universal and intermediate wall supports |  
Convient pour le Support mural universel et intermédiaire

Ref.	4020110	Unidades de embalaje Packing units Unités d'emballage
€ U.	153,90 1	



Abrazadera de unión incluida en todas las piezas.  
Connection bracket included in all parts.  
Collier de fixation inclus dans toutes les pièces.



Junta incluida.  
Gasket included. **\*\* ø80 - 100**  
Joint inclus.

1

400	450	500	550	600	650
5005637	5005638	5005639	5005640	5005641	5005642
25,45 1	26,00 1	28,40 1	30,80 1	33,40 1	35,00 1
450	500	550	600	650	700

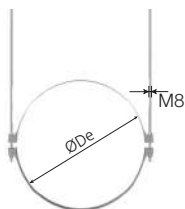

400	450	500	550	600	650
4040425	4040356	4040357	4040358	4040359	4040360
252,15 1	321,65 1	346,85 1	421,40 1	533,90 1	699,05 1
4029487	4029538	4029663	4029776	4030000	4030083
307,50 1	345,80 1	408,00 1	501,55 1	606,65 1	776,70 1

517	567	617	667	717	767
563	613	663	713	763	813

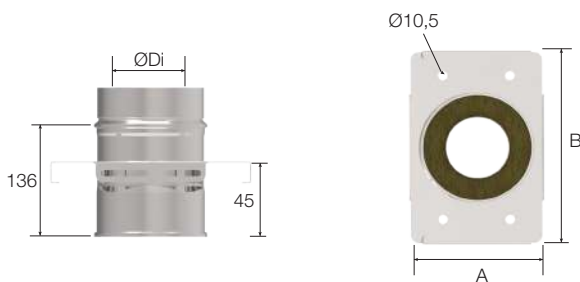

400	450	500	550	600	650
4026062	4026063	4026064	4026066	4026067	4026069
242,05 1	287,20 1	333,70 1	372,55 1	415,95 1	465,60 1

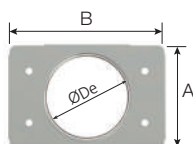

485	535	585	635	685	735
565	615	665	715	765	815
450	500	550	600	650	700

#### Soporte pared regulable | Adjustable wall support | Support mural réglable



		ØDi mm									
		80	100	125	130	150	180	200	250	300	350
AISI 304	Ref.	4600725	4600721	4600722	4600722	4600723	4600726	4600724	4600727	4600728	4600729
	€ U.	98,35	102,70	108,05	108,05	118,90	137,75	148,60	168,75	193,05	222,75
Medidas   Measurements   Mesures											
A		183	203	232	232	252	282	302	351	401	452
B		240	260	290	290	310	340	360	408	458	508
ØDe mm		130	150	180	180	200	230	250	300	350	400

#### Soporte a techo regulable | Adjustable ceiling mounting | Support au toit réglable



		ØDi mm									
		80	100	130	150	180	200	250	300	350	400
AISI 304	Ref.	4013467	4014952	4013529	4012519	4013295	4012428	4015588	4015660	4014552	4040054
	€ U.	85,40	88,15	92,30	92,95	94,30	95,10	97,65	98,20	116,85	134,15
GALVA	Ref.	4012520	4012521	-	4012523	4012524	4012525	-	-	-	-
	€ U.	58,70	58,70	-	58,70	58,70	58,70	-	-	-	-
ØDe mm		130	150	180	200	230	250	300	350	400	450

#### Abrazadera forjado | Ceiling bracket | Collier support plancher



Ø 80-180



Ø 200-650

		ØDi mm									
		80	100	125-130	150	180	200	250	300	350	400
AISI 304	Ref.	4022023	4022025	4022027	4011861	5001470	5001471	5001456	5001472	5001473	5001475
	€ U.	42,95	44,15	45,80	50,85	53,75	55,35	79,65	81,15	98,15	104,60
ØDe mm		130	150	175-180	200	230	250	300	350	400	450

#### Abrazadera forjado reforzada | Reinforced ceiling bracket | Collier support plancher renforcé



		ØDi mm									
		80	100	125-130	150	180	200	250	300	350	400
AISI 304	Ref.	4026828	9023220	4026934	9023221	4026829	4023222	4023223	4023224	4023225	4023226
	€ U.	50,95	51,30	51,80	52,15	54,10	55,85	58,45	59,95	62,10	66,60
Medidas   Measurements   Mesures											
A		103	103	103	103	103	103	103	138	138	138
B		250	250	250	250	250	250	250	300	300	300
ØDe mm		130	150	175-180	200	230	250	300	350	400	450

#### Abrazadera forjado universal | Universal ceiling bracket | Collier support plancher universel \*



1

		ØDi mm									
		80	100	125-130	150	180	200	250	300	350	400
AISI 304	Ref.	4026043	4026044	4026045	4026046	4026047	4026048	4026080	4026081	4026082	4040131
	€ U.	42,10	42,30	42,45	43,40	46,95	47,80	50,90	62,75	72,25	82,30
ØDe mm		130	150	175-180	200	230	250	300	350	400	450

Ref.	4012519	Unidades de embalaje Packing units Unités d'emballage
€ U.	92,95 1	

1

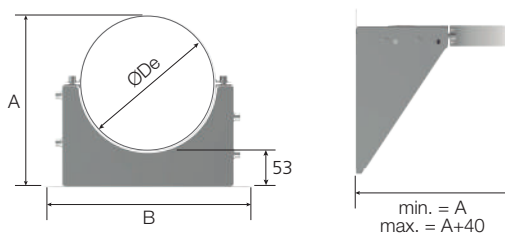

450	500	550	600	650
4040055	4040056	4040057	4040058	4040059
138,40 1	142,65 1	146,85 1	162,75 1	168,75 1
-	-	-	-	-
-	-	-	-	-
500	550	600	650	700

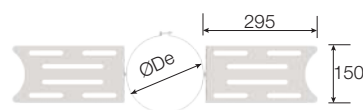

450	500	550	600	650
5001476	5001477	5001478	5001479	5001480
108,60 1	111,70 1	116,40 1	121,90 1	125,65 1
500	550	600	650	700

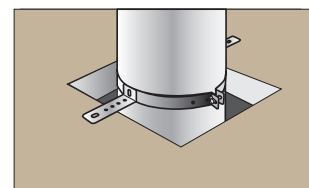
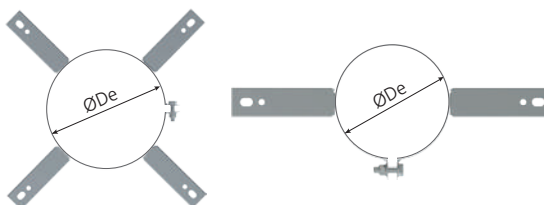

450	500	550	600	650
4026831	4026832	4026833	4026834	4026835
68,60 1	73,05 1	81,35 1	85,85 1	91,15 1
173	173	173	173	173
350	350	350	350	350
500	550	600	650	700

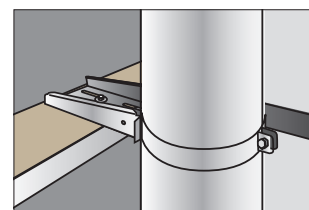
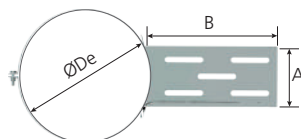

450	500	550	600	650
4040132	4040133	4040134	4040215	4040216
86,30 1	91,10 1	95,85 1	99,35 1	106,50 1
500	550	600	650	700

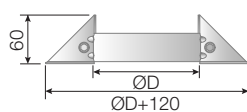

\* Consultar las diferentes opciones de soporte en las páginas 133 y 143.  
For support options, see pages 133 and 143.  
Pour les options de support, voir pages 133 et 143.

# 2 SP

Simple Pared  
Single Wall  
*Simple Paroi*

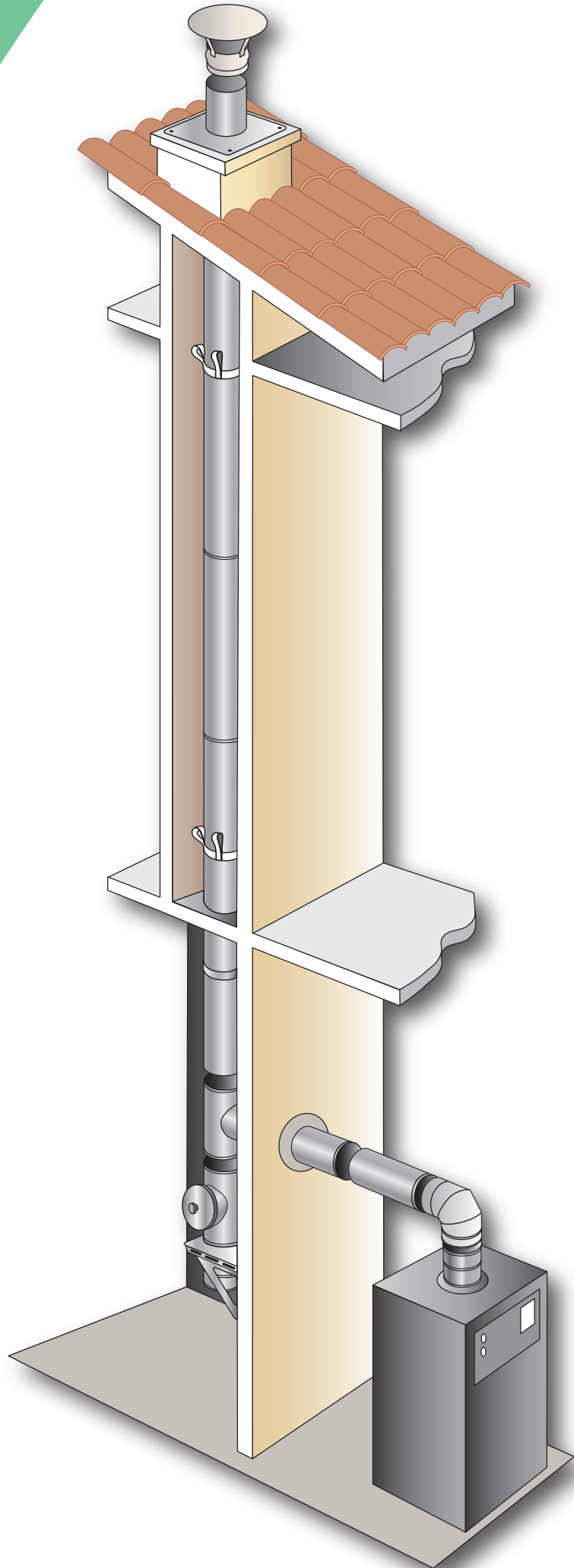





# ROS Pellet

Núm. 14.2/22-2307\_V1

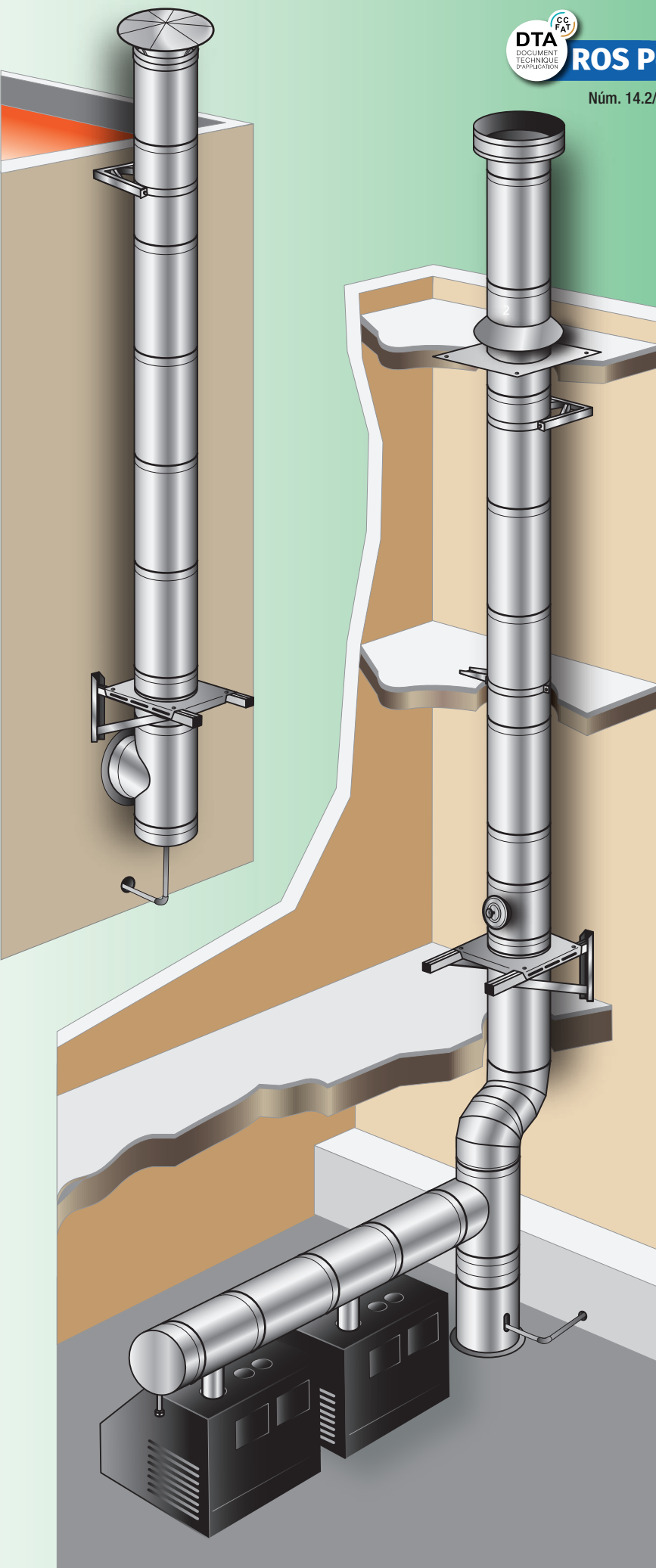

**CE** Especificaciones de acuerdo a la legislación europea en productos de construcción **CPR**  
Specifications according to EU product regulations of construction **CPR**  
Spécifications Selon la réglementation européenne concernant les produits de construction **CPR**

Espeor		Ø80-250	0,4 mm
Thickness		Ø300-400	0,5 mm
Épaisseur		Ø450-700	0,6 mm



**AISI 304**

(1.4301) **2R**

**EN 1856-1**

T200 P1 W Vm L20040 O(30)\*  
T200 N1 W Vm L20040 O(30)  
T300 N1 W Vm L20040 O(75)

**EN 1856-2**

T200 P1 W Vm L20040 O(30)M\*  
T200 N1 W Vm L20040 O(30)M  
T600 N1 W Vm L20040 G(600)M



**AISI 316L**

(1.4404) **2R**

**EN 1856-1**

T200 P1 W V2 L50040 O(30)\*  
T200 N1 W V2 L50040 O(30)  
T300 N1 W V2 L50040 O(75)

**EN 1856-2**

T200 P1 W V2 L50040 O(30)M\*  
T200 N1 W V2 L50040 O(30)M  
T600 N1 W V2 L50040 G(600)M

### Notas: | Notes:

Para diámetros superiores a Ø300 mm, la distancia a los materiales combustibles se debe incrementar mediante un coeficiente.

For diameters more than Ø300 mm, the distance to combustible materials must be increased by a coefficient.

Pour les diamètres supérieurs à Ø300 mm, la distance par rapport aux matériaux combustibles doit être augmentée par un coefficient.

<b>XX Distancia   Distance:</b>	x1,5 (Ø350-450)
	x2 (Ø500-600)
	x3 (Ø650-700)

\* Para cumplir con esta designación todos los elementos deben estar instalados con juntas, consulte la página 54. Para saber el número de juntas, consulte la página 142. Para el resto de elementos, la junta es opcional.

\* To comply with this designation, all elements must be installed with gaskets, see page 54. For the number of gaskets, see page 142. For all other elements, the gasket is optional.

\* Pour respecter cette désignation, tous les éléments doivent être installés avec des joints, voir page 54. Unités de joints par élément, voir page 142. Pour tous les autres éléments, le joint est optionnel.

### Módulo lineal | Linear module | Élément droit



		ØD mm									
		80	100	110	125	130	150	180	200	230	250
<b>L 1000 mm</b>											
AISI 304	Ref.	2700475	2700044	4022225	4013882	2700130	2700199	2700250	2700308	4007270	2700368
	€ U.	29,10 6	33,40 6	34,80 6	35,55 6	36,10 6	40,25 6	48,15 6	53,00 2	68,50 1	72,90 1
AISI 316L	Ref.	4600000**	4600001**	4019524	4016243	4008382	4009355	4009356	4009357	4009358	4009359
	€ U.	40,05 6	45,95 6	48,60 6	49,80 6	50,40 6	54,95 6	67,50 6	72,30 2	91,30 1	97,30 1
<b>L 500mm</b>											
AISI 304	Ref.	2700474	2700043	4022224	4013494	2700129	2700198	2700249	2700307	4007271	2700367
	€ U.	18,50 4	20,95 4	22,30 4	23,00 4	23,50 4	25,55 4	30,85 4	32,65 2	40,10 1	44,45 1
AISI 316L	Ref.	4600020**	4600021**	4019523	4016244	4014912	4014981	4016245	4014390	4016246	4013700
	€ U.	25,85 4	29,35 4	31,20 4	32,05 4	32,85 4	34,85 4	43,20 4	44,55 2	53,60 1	59,25 1
<b>L 250 mm</b>											
AISI 304	Ref.	2700473	2700042	4022223	4013493	2700128	2700197	2700248	2700306	4007422	2700366
	€ U.	12,15 4	14,20 4	15,25 4	16,40 4	16,65 4	17,70 4	21,70 4	23,25 2	25,55 1	30,15 1
AISI 316L	Ref.	4600030**	4016229**	4019522	4016230	4015437	4016231	4016232	4014829	4016233	4016234
	€ U.	17,40 4	20,45 4	21,30 4	23,00 4	23,30 4	24,40 4	30,35 4	31,70 2	33,95 1	40,10 1

### Módulo extensible | Extendable module | Élément télescopique



		ØD mm									
		80	100	110	125	130	150	180	200	230	250
<b>Lmin 500 mm - Lmax 900 mm</b>											
AISI 304	Ref.	4022230	4022231	4022232	4013522	2700127	2700636	2700982	2700304	4022351	2700616
	€ U.	40,70 2	43,75 2	47,95 2	50,40 2	51,10 2	58,55 2	68,75 2	73,60 2	91,65 1	103,30 1
AISI 316L	Ref.	4600070**	4600071**	4022301	4016650	4016652	4016653	4015914	4014801	4022352	4016654
	€ U.	56,65 2	61,25 2	67,15 2	70,60 2	71,55 2	79,90 2	96,25 2	100,40 2	122,10 1	137,85 1
<b>Lmin 335 mm - Lmax 565 mm</b>											
AISI 304	Ref.	2700788	2700041	4022229	4013521	2700126	2700196	2700246	2700302	4007710	2700364
	€ U.	31,20 2	35,25 2	39,05 2	41,90 2	42,45 2	45,70 2	54,15 2	57,10 2	68,00 1	72,35 1
AISI 316L	Ref.	4010847**	4016643**	4019526	4016644	4014503	4014982	4016645	4014389	4016646	4014983
	€ U.	44,00 2	49,80 2	54,60 2	58,65 2	59,35 2	62,35 2	75,80 2	77,85 2	90,65 1	96,55 1
<b>Lmin 200 mm - Lmax 300 mm</b>											
AISI 304	Ref.	4015157	4012190	4022228	4013506	4007937	4008146	4008147	2700305	4012710	4007466
	€ U.	27,50 2	29,75 2	31,30 2	32,65 2	33,00 2	36,25 2	42,40 2	44,70 2	56,00 1	57,90 1
AISI 316L	Ref.	4600060**	4600061**	4019525	4016634	4016635	4016636	4016637	4014802	4016638	4016639
	€ U.	39,15 2	42,60 2	43,75 2	45,70 2	46,20 2	49,40 2	59,25 2	61,05 2	74,40 1	77,30 1

### Tubo descenso | Down piping | Élément descente 1000 mm



		ØD mm					
		450	500	550	600	650	700
AISI 304	Ref.	4040109	4040110	4040111	4040112	4040113	4040114
	€ U.	217,00 1	234,25 1	277,30 1	323,75 1	378,95 1	447,95 1
AISI 316L	Ref.	4040115	4040116	4040117	4040118	4040119	4040120
	€ U.	237,25 1	294,95 1	353,70 1	425,25 1	490,95 1	584,60 1

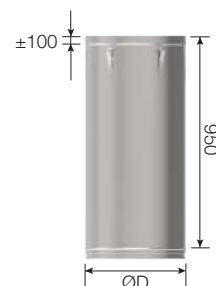

Ref.	2700199	Unidades de embalaje Packing units Unités d'emballage
€ U.	40,25 <b>6</b>	



**Abrazadera de unión incluida en todas las piezas.**  
Connection bracket included in all parts.  
*Collier de fixation inclus dans toutes les pièces.*



**Junta incluida.**  
Gasket included. **\*\***  
*Joint inclus.* **ø80 - 100**

300	350	400	450	500	550	600	650	700
-----	-----	-----	-----	-----	-----	-----	-----	-----

2700413	2700436	2700448	4029576	4029699	4029850	4030039	4030124	4040100
<b>99,15</b>	<b>111,80</b>	<b>124,00</b>	<b>158,45</b>	<b>185,90</b>	<b>229,20</b>	<b>276,80</b>	<b>329,55</b>	<b>400,00</b>
4009360	4009361	4009362	4028610	4029746	4029926	4030065	4030208	4040243
<b>132,70</b>	<b>149,15</b>	<b>166,05</b>	<b>191,35</b>	<b>245,80</b>	<b>307,60</b>	<b>376,35</b>	<b>442,30</b>	<b>536,35</b>

2700412	2700619	2700447	4029578	4029701	4029852	4030041	4030126	4040101
<b>52,95</b>	<b>62,20</b>	<b>69,55</b>	<b>94,25</b>	<b>111,75</b>	<b>141,65</b>	<b>172,65</b>	<b>201,20</b>	<b>243,75</b>
4015434	4016247	4016248	4029645	4029748	4029928	4030067	4030210	4040244
<b>70,90</b>	<b>82,70</b>	<b>93,15</b>	<b>126,25</b>	<b>147,45</b>	<b>189,75</b>	<b>234,80</b>	<b>269,50</b>	<b>326,55</b>

2700411	2700435	2700446	4029577	4029700	4029851	4030040	4030125	4040102
<b>32,95</b>	<b>39,10</b>	<b>43,25</b>	<b>88,60</b>	<b>109,10</b>	<b>134,60</b>	<b>162,40</b>	<b>192,80</b>	<b>233,65</b>
4015551	4016235	4016236	4029644	4029747	4029927	4030066	4030209	4040245
<b>44,20</b>	<b>51,95</b>	<b>57,95</b>	<b>107,30</b>	<b>144,05</b>	<b>180,25</b>	<b>220,85</b>	<b>258,20</b>	<b>313,05</b>

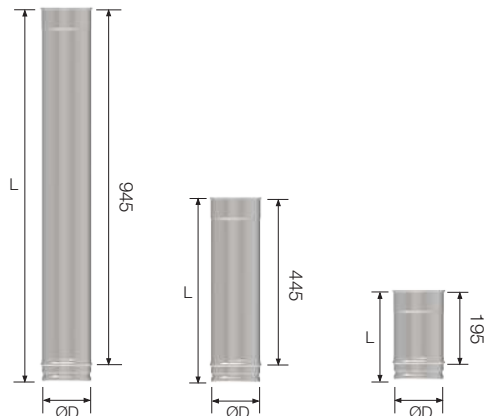

300	350	400	450	500	550	600	650	700
-----	-----	-----	-----	-----	-----	-----	-----	-----

2700594	4008023	4009335	4029565	4029684	4029825	4030026	4030112	4040105
<b>132,95</b>	<b>157,65</b>	<b>176,05</b>	<b>273,80</b>	<b>328,85</b>	<b>397,95</b>	<b>458,55</b>	<b>534,70</b>	<b>622,20</b>
4016655	4016656	4016657	4029628	4029732	4029899	4030050	4030142	4040108
<b>178,15</b>	<b>210,15</b>	<b>235,80</b>	<b>348,10</b>	<b>433,95</b>	<b>533,15</b>	<b>623,60</b>	<b>716,50</b>	<b>833,65</b>

2700410	2700434	2700444	4029564	4029683	4029824	4030025	4030111	4040104
<b>101,10</b>	<b>116,15</b>	<b>137,20</b>	<b>194,75</b>	<b>234,30</b>	<b>283,70</b>	<b>326,00</b>	<b>379,60</b>	<b>444,45</b>
4016647	4016648	4016649	4029627	4029724	4029898	4030049	4030141	4040107
<b>135,45</b>	<b>154,80</b>	<b>183,80</b>	<b>241,90</b>	<b>309,25</b>	<b>380,05</b>	<b>443,35</b>	<b>508,60</b>	<b>595,65</b>

4015158	4015159	4015160	4032467	4032468	4032469	4032470	4032471	4040103
<b>84,20</b>	<b>96,80</b>	<b>114,35</b>	<b>163,05</b>	<b>194,95</b>	<b>238,65</b>	<b>277,15</b>	<b>327,60</b>	<b>384,70</b>
4015537	4016640	4016642	4032472	4032473	4032474	4032475	4032476	4040106
<b>112,90</b>	<b>128,75</b>	<b>153,25</b>	<b>197,30</b>	<b>257,20</b>	<b>319,65</b>	<b>376,95</b>	<b>439,05</b>	<b>515,45</b>

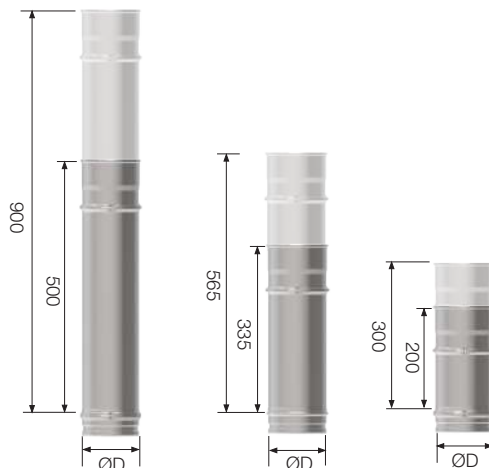

2

### Codo | Elbow | Coude 15°



ØD mm		80	100	110	125	130	150	180	200	230	250
AISI 304	Ref.	4022332	4022333	4022334	4022335	4022336	4022338	4022340	4022341	4022342	4022343
	€ U.	32,05 4	32,75 4	32,80 4	35,15 4	35,35 4	36,50 4	41,15 4	42,50 4	43,80 1	44,65 1
AISI 316L	Ref.	4019654**	4019656**	4019658	4020155	4019659	4019660	4019661	4019662	4020156	4019663
	€ U.	38,20 4	39,10 4	40,05 4	40,65 4	41,00 4	41,95 4	47,25 4	48,90 4	50,30 1	51,35 1
Medidas   Measurements   Mesures											
H		21	21	21	22	22	22	23	23	23	24
V		114	117	118	120	121	123	127	130	133	136

### Codo | Elbow | Coude 30°



ØD mm		80	100	110	125	130	150	180	200	230	250
AISI 304	Ref.	4014431	4018796	4022349	4013535	4007665	2700631	2700981	4007664	4009540	2700355
	€ U.	17,00 4	19,45 4	20,55 4	24,25 4	24,55 4	25,60 4	32,85 4	38,55 4	41,95 1	46,20 1
AISI 316L	Ref.	4015623**	4019645**	4019531	4016557	4016558	4014976	4016559	4014979	4016560	4014980
	€ U.	23,75 4	27,30 4	28,35 4	33,40 4	33,85 4	35,40 4	45,35 4	53,40 4	58,15 1	64,00 1
Medidas   Measurements   Mesures											
H		43	44	45	46	46	48	50	51	53	54
V		111	117	119	123	124	129	136	141	148	153

### Codo | Elbow | Coude 45°



ØD mm		80	100	110	125	130	150	180	200	230	250
AISI 304	Ref.	2700468	2700036	4022350	4013536	2700122	2700191	2700242	2700296	4007272	2700356
	€ U.	17,00 4	19,45 4	20,55 4	24,25 4	24,55 4	25,60 4	32,85 4	38,55 4	41,95 1	46,20 1
AISI 316L	Ref.	4600080**	4600081**	4019532	4016563	4014913	4014984	4016564	4014388	4016565	4014985
	€ U.	23,75 4	27,30 4	28,35 4	33,40 4	33,85 4	35,40 4	45,35 4	53,40 4	58,15 1	64,00 1
Medidas   Measurements   Mesures											
H		63	66	67	69	70	73	76	79	83	86
V		116	123	126	131	133	140	149	156	167	173

### Codo | Elbow | Coude 87°



ØD mm		80	100	110	125	130	150	180	200	230	250
AISI 304	Ref.	2700469	2700037	9022075	4013537	2700123	2700192	2700243	2700298	4022284	2700358
	€ U.	24,90 4	27,65 4	30,10 4	31,75 4	32,25 4	33,80 4	39,20 4	43,50 4	56,30 1	62,35 1
AISI 316L	Ref.	4600090**	4600091**	4019533	4016567	4014915	4010654	4016556	4014800	4022285	4014986
	€ U.	34,90 4	38,70 4	41,40 4	43,80 4	44,45 4	46,80 4	54,10 4	60,10 4	77,35 1	86,55 1
Medidas   Measurements   Mesures											
H		138	148	153	161	163	173	187	197	212	222
V		91	100	105	112	115	124	137	147	161	170

### Codo con soporte | Elbow with bracket | Coude avec support 87°



ØD mm		80	100	110	125	130	150	180	200	230	250
AISI 316L	Ref.	4019930**	4019931**	4019932	4022288	4019933	4019934	4019935	4019936	4022295	4019937
	€ U.	80,60 4	84,40 4	93,55 4	102,55 4	103,00 4	111,95 4	119,35 4	144,90 4	188,20 1	197,45 1
Medidas   Measurements   Mesures											
H		98	108	113	120	123	133	147	157	172	182
V1		133	143	148	155	157	167	180	189	204	213
V2		191	211	221	236	241	263	291	311	341	359
A		96	112	120	132	136	158	180	196	220	239

Ref.	2700631	Unidades de embalaje Packing units Unités d'emballage
€ U.	25,60 <span style="border: 1px solid red; border-radius: 50%; padding: 2px;">4</span>	



**Abrazadera de unión incluida en todas las piezas.**  
Connection bracket included in all parts.  
*Collier de fixation inclus dans toutes les pièces.*



**Junta incluida.**  
Gasket included.  
*Joint inclus.*

**\*\* ø80 - 100**

300	350	400	450	500	550	600	650	700
4022344	4022345	4025190	4029559	4029679	4029818	4030016	4030107	4040121
<b>56,10</b>	<b>58,70</b>	<b>62,05</b>	<b>139,60</b>	<b>172,85</b>	<b>212,75</b>	<b>259,20</b>	<b>306,95</b>	<b>369,45</b>
4019664	4019665	4025191	4029617	4029719	4029868	4030045	4030135	4040125
<b>64,50</b>	<b>67,55</b>	<b>72,25</b>	<b>188,45</b>	<b>214,00</b>	<b>265,80</b>	<b>322,95</b>	<b>380,05</b>	<b>458,40</b>

25	25	26	43	44	45	46	47	48
142	149	155	282	288	295	301	308	314

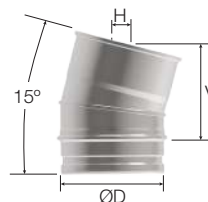

300	350	400	450	500	550	600	650	700
4008150	4009541	4028109	4029560	4029680	4029819	4030018	4030108	4040122
<b>64,00</b>	<b>79,00</b>	<b>86,05</b>	<b>171,95</b>	<b>211,65</b>	<b>254,10</b>	<b>298,70</b>	<b>348,45</b>	<b>420,50</b>
4016561	4016562	4029513	4029618	4029721	4029869	4030046	4030136	4040126
<b>88,75</b>	<b>109,60</b>	<b>143,00</b>	<b>203,60</b>	<b>248,25</b>	<b>296,05</b>	<b>331,45</b>	<b>401,50</b>	<b>479,70</b>

58	61	64	115	118	122	125	128	132
166	178	191	382	395	407	420	432	445

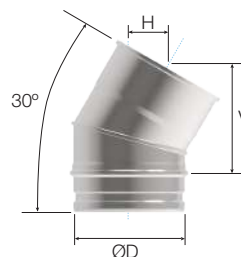

300	350	400	450	500	550	600	650	700
2700404	2700432	2700443	4029561	4029681	4029820	4030019	4030109	4040123
<b>64,00</b>	<b>79,00</b>	<b>86,05</b>	<b>184,90</b>	<b>227,45</b>	<b>273,15</b>	<b>321,20</b>	<b>374,50</b>	<b>452,00</b>
4015041	4013096	4016566	4029619	4029722	4029870	4030047	4030137	4040127
<b>88,75</b>	<b>109,60</b>	<b>143,00</b>	<b>218,85</b>	<b>266,80</b>	<b>318,30</b>	<b>371,75</b>	<b>431,55</b>	<b>515,60</b>

93	100	107	178	185	193	200	207	215
191	208	225	367	385	403	420	438	456

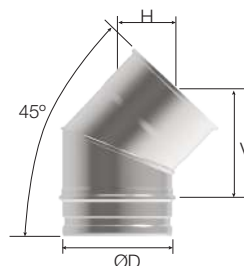

300	350	400	450	500	550	600	650	700
2700405	2700433	2700635	-	-	-	-	-	-
<b>102,75</b>	<b>125,90</b>	<b>149,95</b>	-	-	-	-	-	-
4015433	4016568	4016569	4029626	4029723	4029897	4030048	4030138	4040128
<b>142,75</b>	<b>162,35</b>	<b>193,45</b>	<b>252,00</b>	<b>309,40</b>	<b>369,70</b>	<b>432,00</b>	<b>505,95</b>	<b>601,40</b>

247	272	297	456	481	506	531	556	581
194	218	242	478	502	526	550	573	597

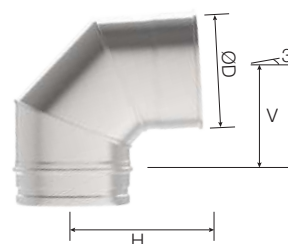

300	350	400
4019938	4019939	4019940
<b>253,60</b>	<b>305,80</b>	<b>336,85</b>

207	232	257
237	260	284
409	459	509
279	319	359

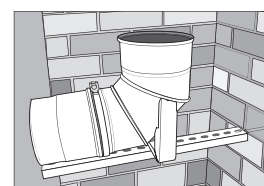
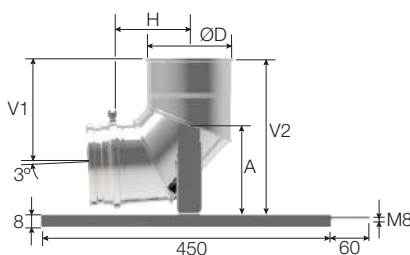

2

### Te | "T" piece | Té 90° \*



		ØD mm									
		80	100	110	125	130	150	180	200	230	250
AISI 304	Ref.	4022162	4022163	4022164	4022165	4022166	4022168	4022171	4022172	4022173	4022174
	€ U.	33,80 3	37,10 3	39,60 3	41,45 3	43,00 3	50,20 2	60,05 2	70,65 2	77,70 1	91,30 1
AISI 316L	Ref.	4022035**	4022036**	4019527	4022037	4022038	4022040	4022042	4022043	4022045	4022047
	€ U.	45,00 3	52,85 3	54,10 3	56,35 3	58,35 3	67,20 2	82,20 2	91,30 2	100,45 1	118,10 1
Medidas   Measurements   Mesures											
H		90	100	105	113	115	125	139	149	164	174
V		75	85	90	100	100	117	126	136	151	161
L		193	213	223	243	243	276	293	313	343	363

### Te | "T" Piece | Té 93° \*



		ØD mm									
		80	100	110	125	130	150	180	200	230	250
AISI 304	Ref.	4019580	4019581	4022195	4019582	4019583	4019584	4019585	4019586	4019587	4019588
	€ U.	33,80 3	37,10 3	39,60 3	41,45 3	43,00 3	50,20 2	60,05 2	70,65 2	77,70 1	91,30 1
AISI 316L	Ref.	4022073**	4022074**	9022076	9022077	4022078	4022080	4022082	4022083	4022084	4022085
	€ U.	45,00 3	52,85 3	54,10 3	56,35 3	58,35 3	67,20 2	82,20 2	91,30 2	100,45 1	118,10 1
Medidas   Measurements   Mesures											
H		92	103	108	116	119	129	144	154	170	181
V		70	80	85	94	94	110	118	127	142	151
L		193	213	223	243	243	276	293	313	343	363

### Te | "T" Piece | Té 135° \*



		ØD mm									
		80	100	110	125	130	150	180	200	230	250
AISI 304	Ref.	4022237	4022238	4022239	4022240	4022242	4022244	4018147	4022246	4022247	4022248
	€ U.	60,65 2	64,05 2	65,45 2	68,50 2	71,55 2	104,00 2	117,20 2	144,35 2	157,25 1	174,00 1
AISI 316L	Ref.	4022250**	4022251**	4019528	4022254	4022255	4022257	4022262	4022264	4022265	4022269
	€ U.	69,70 2	73,70 2	75,35 2	78,80 2	82,20 2	119,55 2	134,80 2	166,05 2	187,75 1	209,50 1
Medidas   Measurements   Mesures											
H		111	128	137	149	154	171	195	212	237	254
V		21	28	32	37	39	46	56	63	73	80
L		227	256	270	291	298	326	366	394	437	465

### Te base con tapa | Base "T" Piece with cap | Té base avec tampon 90°



		ØD mm							
		80	100	110	125	130	150	180	200
AISI 316L	Ref.	4021627**	4011365**	-	4034949	4034950	4034951	4034952	4034953
	€ U.	73,85 1	82,65 1	-	89,40 1	91,95 1	101,85 1	122,50 1	133,95 1
Medidas   Measurements   Mesures									
A		93	103	-	115	118	128	142	152
L		237	237	-	245	272	287	320	337

### Tapa | Cap | Tampon



		ØD mm									
		80	100	110	125	130	150	180	200	230	250
AISI 316L	Ref.	4010844	4015924	4019529	4015926	4015927	4014992	4015928	4014991	4016288	4014993
	€ U.	28,95 4	29,95 4	31,65 4	33,20 4	33,70 4	34,75 4	40,40 4	42,70 4	44,30 1	52,40 1
Medidas   Measurements   Mesures											
H		75	75	75	75	75	75	75	75	75	75

### Tapa purga | Condensate cap | Tampon récupérateur condensats



		ØD mm									
		80	100	110	125	130	150	180	200	230	250
AISI 316L	Ref.	4015544	4015955	4019530	4015932	4014506	4015057	4015933	4014393	4022403	4014923
	€ U.	31,10 4	32,25 4	34,00 4	35,75 4	36,20 4	37,40 4	43,50 4	45,95 4	47,75 1	56,30 1
Medidas   Measurements   Mesures											
H		75	75	75	75	75	75	75	75	75	75
ØG		1/2"	1/2"	1/2"	1/2"	1/2"	1/2"	3/4"	3/4"	3/4"	3/4"

### Tapa purga lateral | Lateral purge cap | Tampon récupérateur condensats laterale

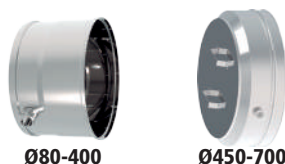

		ØD mm									
		80	100	110	125	130	150	180	200	230	250
AISI 316L	Ref.	4019678	4019680	4019691	4022405	4019692	4019693	4019694	4019695	4022408	4019696
	€ U.	43,80 1	45,25 1	46,20 1	46,90 1	47,55 1	49,15 1	51,65 1	54,10 1	65,10 1	82,70 1
Medidas   Measurements   Mesures											
H		95	95	95	95	95	95	95	95	95	95
ØG		1/2"	1/2"	1/2"	1/2"	1/2"	1/2"	3/4"	3/4"	3/4"	3/4"

Ref.	4022168	Unidades de embalaje Packing units Unités d'emballage
€ U.	50,20	



Abrazadera de unión incluida en todas las piezas.  
Connection bracket included in all parts.  
Collier de fixation inclus dans toutes les pièces.



Junta incluida.  
Gasket included.  
Joint inclus.

\*\* ø80 - 100

300	350	400	450	500	550	600	650	700
4022221	2700978	4009296	4029574	4029697	4029848	4030037	4030122	4040161
116,25	193,20	255,50	316,10	376,75	458,55	537,60	626,40	711,10
4022048	4022049	4022051	-	-	-	-	-	-
150,25	228,50	306,80	-	-	-	-	-	-

199	224	249	295	320	345	370	395	420
201	211	236	306	331	356	381	406	456
443	463	513	700	750	800	850	900	950

300	350	400	450	500	550	600	650	700
4019589	4019590	4019591	-	-	-	-	-	-
116,25	193,20	255,50	-	-	-	-	-	-
9022086	4022087	4022088	4029642	4029744	4029925	4030064	4030207	4040162
150,25	228,50	306,80	373,90	447,35	527,70	619,40	704,05	801,30

207	233	259	307	334	360	386	413	439
190	198	222	306	331	356	381	406	456
443	463	513	700	750	800	850	900	1000

300	350	400	450	500	550	600	650	700
4011126	4022249	4011173	4033789	4033790	4033791	4033792	4033793	4040163
190,80	245,30	272,45	383,40	492,70	582,70	998,80	1.160,95	1.239,75
4022271	4022272	4022273	4033794	4033795	4033796	4033797	4033798	4040164
254,30	317,90	351,95	438,15	568,05	677,60	1.171,55	1.373,50	1.483,70

297	340	382	464	492	519	583	611	638
98	116	133	189	201	213	238	251	263
536	606	677	850	900	950	1050	1100	1150

300	350	400	450	500	550	600	650	700
4015953	4015929	4015930	4029635	4029739	4029913	4030057	4030202	4040166
76,15	99,95	113,75	133,40	140,75	149,50	170,00	192,00	222,70
75	75	75	158	184	208	232	257	282

300	350	400	450	500	550	600	650	700
4015554	4015934	4015935	4029634	4029738	4029905	4030056	4030201	4040168
83,40	109,50	124,55	150,05	158,35	168,20	191,30	216,00	250,55
75	75	75	158	184	208	232	257	282
1"	1"	1"	1"	1"	1"	1"	1"	1"

300	350	400	450	500	550	600	650	700
4019697	4019698	4035156	4035165	4035166	4035167	4035168	4035169	4040169
108,15	127,75	165,35	200,20	222,85	238,95	277,75	316,50	360,10
95	95	95	158	184	208	232	257	282
1"	1"	1"	1"	1"	1"	1"	1"	1"

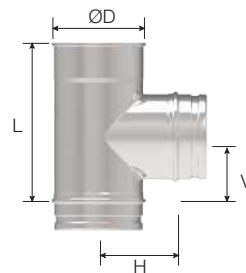

\* No incluye tapa  
Cover not included  
Couvercle non inclus

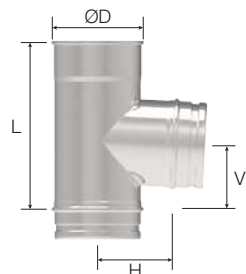

\* No incluye tapa  
Cover not included  
Couvercle non inclus

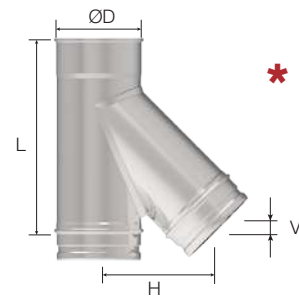

\* No incluye tapa  
Cover not included  
Couvercle non inclus

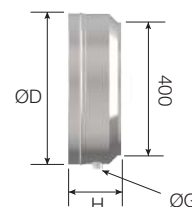
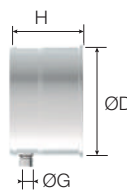
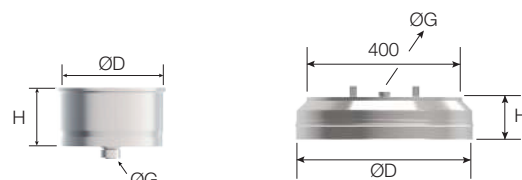
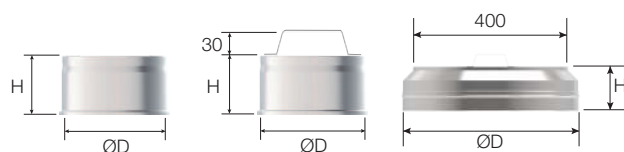
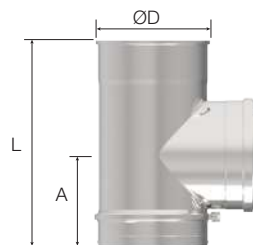

2

### Módulo purga lateral | Lateral purge module | Module récupérateur condensats latérale



		ØD mm									
		80	100	110	125	130	150	180	200	230	250
AISI 316L	Ref.	4020210**	4020211**	-	4020212	4020213	4020214	4020215	4020216	4020217	4020218
	€ U.	52,50	54,20	-	56,95	56,95	58,95	62,00	64,90	77,90	99,15
Medidas   Measurements   Mesures											
		ØG	1/2"	1/2"	-	1/2"	1/2"	1/2"	3/4"	3/4"	3/4"

### Regulador de tiro | Draft regulator | Modérateur de tirage

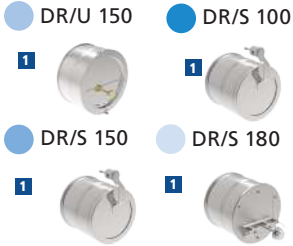

		ØD mm									
		80	100	110	125	130	150	180	200	230	250
AISI 304	Ref.	-	-	-	-	4025655	4025656	4025657	-	-	-
	€ U.	-	-	-	-	121,95	123,00	135,65	-	-	-
Medidas   Measurements   Mesures											
		ØG	1/2"	1/2"	-	1/2"	1/2"	1/2"	3/4"	3/4"	3/4"

### Módulo de limpieza oval con tapa | Oval cleaning module with cap | Module ramonage ovale avec trappe \*



		ØD mm							
		80	100	110	125	130	150	180	200
AISI 316L	Ref.	-	4017160**	-	-	4017162	-	-	4017165
	€ U.	-	96,55	-	-	107,30	-	-	162,25

\* Disponible hasta fin de existencias.  
Available until stocks last.  
Jusqu'à épuisement des stocks.

### Módulo de inspección | Inspection module | Module inspection



		ØD mm									
		80	100	110	125	130	150	180	200	230	250
AISI 304	Ref.	4021835	4021836	4021837	4021838	4021839	4021840	4021841	4021842	4021843	4021844
	€ U.	45,60	50,10	53,35	56,00	57,95	67,75	81,10	95,40	104,90	118,80
AISI 316L	Ref.	4020116**	4020117**	4020118	4020157	4020119	4020120	4020121	4020122	4020158	4020123
	€ U.	62,05	70,50	71,55	72,95	76,70	84,00	102,75	114,20	136,20	141,70
Medidas   Measurements   Mesures											
		H	73	83	88	98	98	108	122	132	156
		L	194	214	223	244	244	277	294	314	343
		*ØT	80	100	110	130	130	150	180	200	250

### Codo inspección | Inspection elbow | Coude inspection

87°



		ØD mm									
		80	100	110	125	130	150	180	200	230	250
AISI 316L	Ref.	4024385**	4024387**	-	4024390	4024391	4024392	4024393	4024394	-	4024395
	€ U.	99,35	110,05	-	122,45	124,15	128,40	150,30	162,15	-	198,10
Medidas   Measurements   Mesures											
		H	154	166	-	181	184	197	214	226	256
		V	119	132	-	148	152	165	182	195	228
		*ØT	80	100	-	130	130	150	180	200	250

### Tapa de inspección | Inspection cover | Trappe d'inspection

200° C / 200 Pa

450° C / 40 Pa



Resistente a condensados  
Condensate-resistant  
Résistant aux condensats

Para combustibles sólidos  
For solid fuels  
Pour combustibles solides

		ØD mm									
		80	100	110	125	130	150	180	200	230	250
200° C / 200 Pa											
AISI 304	Ref.	5003265	5003266	5004391	5003267	5003267	5003268	5003269	5003270	5003270	5003271
	€ U.	25,75	26,20	28,45	30,70	30,70	33,85	44,50	48,15	48,15	70,75
450° C / 40 Pa											
AISI 304	Ref.	5003391	5003392	5004389	5003393	5003393	5003394	5003395	5003396	5003396	5003397
	€ U.	36,05	41,60	45,00	47,10	47,10	52,60	60,45	66,75	66,75	98,90
Medidas   Measurements   Mesures											
		ØT	80	100	110	130	130	150	180	200	250



Ref.	4020214	Unidades de embalaje Packing units Unités d'emballage
€ U.	58,95	1



**Abrazadera de unión incluida en todas las piezas.**  
Connection bracket included in all parts.  
*Collier de fixation inclus dans toutes les pièces.*



**Junta incluida.**  
Gasket included.  
*Joint inclus.*

**\*\* ø80 - 100**

300	350	400	450	500	550	600	650	700
4020219	4020220	4020221	4040209	4040210	4040211	4040212	4040213	4040214
129,75	153,30	198,40	226,30	251,85	313,85	270,10	357,60	406,85
1"	1"	1"	1"	1"	1"	1"	1"	1"

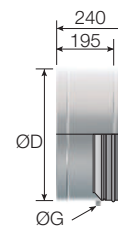
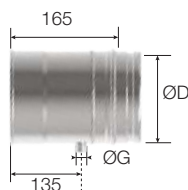

2

1

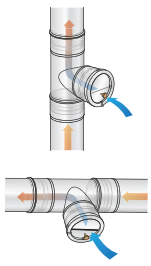
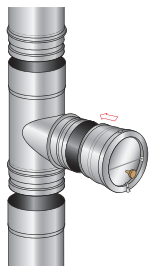

en vertical  
vertically  
verticalement

en horizontal  
horizontally  
horizontalement

**Montaje del regulador de tiro**  
Draft regulator assembly  
*Montage du modérateur de tirage*

**1** Montado en una Te de 90°. Vea la ilustración  
Mounted on a 90° "T" Piece. See the image  
*Se monte sur un Té 90°. Voir illustration*

**Sifón | Siphon | Siphone**



Ref.	4030741
€ U.	41,00
	1

max. 160° C

300	350	400	450	500	550	600	650	700
4021845	4021846	4029517	4029566	4029685	4029840	4030027	4030113	4040182
151,15	231,80	306,60	363,50	433,25	527,30	618,15	720,40	817,65
4020124	4020125	4029516	4029629	4029733	4029900	4030051	4030147	4040183
192,10	262,85	352,85	436,25	520,45	632,80	741,80	864,35	981,25
182	216	241	275	300	325	350	375	400
444	464	514	455	455	455	455	455	455
300	300	300	300	300	300	300	300	300

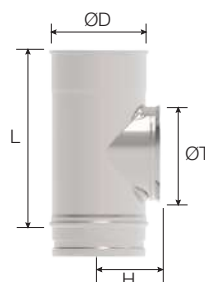
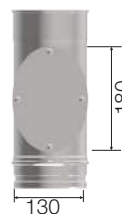

\* No incluye tapa.  
Cover not included.  
*Couvercle non inclus.*

300	350	400	450	500	550	600	650	700
4017353	4033096	4033097	4033098	4033099	4033100	4033101	4033102	4040190
234,70	258,95	280,40	390,65	479,70	554,40	626,30	733,65	871,95
287	318	348	626	649	673	697	720	744
260	292	325	597	622	647	672	697	722
300	300	300	300	300	300	300	300	300

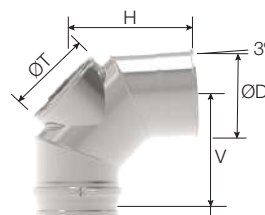

\* No incluye tapa.  
Cover not included.  
*Couvercle non inclus.*

300	350	400	450	500	550	600	650	700
5003272								
97,45								
5003398								
125,70								
300								

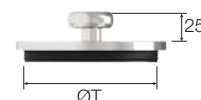
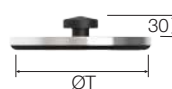

### Módulo analizador gas | Gas analyzer module | Module analyseur de gaz



		ØD mm									
		80	100	110	125	130	150	180	200	230	250
AISI 304	Ref.	2700472	2700040	-	4013894	2700125	2700195	2700245	2700301	-	2700363
	€ U.	45,95	47,85	-	49,10	49,25	50,35	51,70	59,20	-	62,60
AISI 316L	Ref.	4010846**	4011364**	-	2700806	4014502	4019105	2700810	4016097	-	2700812
	€ U.	57,55	59,35	-	61,40	63,30	66,75	69,20	74,90	-	85,10

### Módulo analizador gas y temperatura | Gas and temperature analyzer module | Module analyseur de gaz et de température \*



		ØD mm									
		80	100	110	125	130	150	180	200	230	250
AISI 304	Ref.	4016715	4016716	-	4016717	4016718	4016719	4016720	4016721	-	4016722
	€ U.	98,95	103,80	-	105,25	105,45	106,70	116,60	130,80	-	150,95
AISI 316L	Ref.	4017170**	4017171**	-	4017172	4017173	4017174	4017175	4017177	-	4017178
	€ U.	113,35	116,85	-	121,50	122,15	124,00	135,70	146,25	-	161,95

\* Pirómetro incluido | Pyrometer included | Pyromètre inclus

### Tapa condensación | Condensate cap | Tampon récupérateur condensats



		ØD mm									
		80	100	110	125	130	150	180	200	230	250
AISI 316L	Ref.	4027439**	4027440**	4027441	4027442	4027443	4027445	4027447	4027448	4027449	4027450
	€ U.	48,15	49,20	49,75	51,10	51,35	56,45	58,85	60,45	69,90	71,90
Medidas   Measurements   Mesures											
ØG		1/2"	1/2"	1/2"	1/2"	1/2"	1/2"	3/4"	3/4"	3/4"	3/4"

### Tubo recortable | Cut-out piping | Élément recoupable 1000 mm, 500 mm

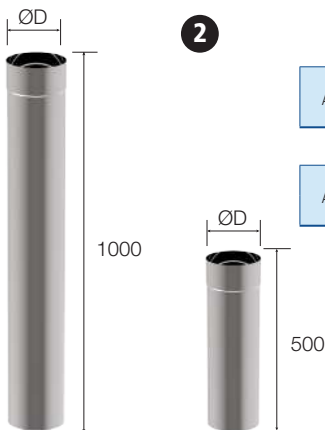

		ØD mm									
		80	100	110	125	130	150	180	200	230	250
		<b>L 1000 mm</b>									
AISI 304	Ref.	4019893	4019894	4027456	4019895	4019895	4019896	4019897	4019898	4019899	4019900
	€ U.	33,45	37,55	43,55	48,45	48,45	52,85	68,85	74,05	90,05	100,10
		<b>L 500 mm</b>									
AISI 304	Ref.	4019883	4019884	4027454	4019885	4019885	4019886	4019887	4019888	4019889	4019890
	€ U.	29,10	31,50	34,20	35,90	35,90	37,75	41,00	44,00	52,20	54,85

### Base inicial con salida lateral | Floor base with lateral outlet | Plaque de départ avec sortie latérale



		ØD mm									
		80	100	110	125	130	150	180	200	230	250
AISI 304	Ref.	4021877	4027432	4027433	4021875	4021875	4021876	4019971	4019973	4019974	4019975
	€ U.	61,70	64,70	67,40	69,15	69,15	76,10	90,45	96,55	104,65	112,85

Ref.	4016719	Unidades de embalaje Packing units Unités d'emballage
€ U.	106,70 1	



**Abrazadera de unión incluida en todas las piezas.**  
Connection bracket included in all parts.  
*Collier de fixation inclus dans toutes les pièces.*



**Junta incluida.**  
Gasket included. **\*\* ø80 - 100**  
*Joint inclus.*

300	350	400	450	500	550	600	650	700
2700409	2700804	2700805	-	-	-	-	-	-
77,95 1	90,80 1	107,70 1	-	-	-	-	-	-
2700813	2700814	2700815	4040197	4040198	4040199	4040200	4040201	4040202
104,00 1	124,15 1	136,00 1	173,35 1	208,75 1	256,35 1	304,95 1	358,05 1	431,20 1

300	350	400
4016723	4016724	4016725
173,30 1	193,70 1	224,50 1
4017179	4017180	4017181
209,65 1	245,85 1	259,40 1

300	350	400	450	500	550	600	650	700
4027451	4027452	4027453	4028611	4029740	4029922	4030058	4030203	4040307
84,70 1	89,55 1	95,50 1	172,55 1	182,00 1	193,45 1	219,90 1	248,30 1	288,05 1
1"	1"	1"	1"	1"	1"	1"	1"	1"

300	350	400	450	500	550	600	650	700
4019901	4022057	4022058	4028614	4040400	4040401	4040402	4040403	4040404
126,35 1	164,80 1	181,80 1	198,20 1	227,95 1	276,45 1	328,15 1	382,75 1	456,15 1

300	350	400	450	500	550	600	650	700
4019891	4022050	4022056	4040405	4040406	4040407	4040408	4040409	4040410
77,65 1	102,65 1	113,20 1	117,15 1	135,60 1	169,15 1	202,65 1	232,10 1	276,55 1

300	350	400	450	500	550	600	650	700
4019977	4019978	4022033	4028612	4040412	4040413	4040414	4040415	4040416
128,10 1	146,45 1	166,30 1	242,10 1	293,90 1	355,20 1	423,50 1	499,45 1	605,60 1

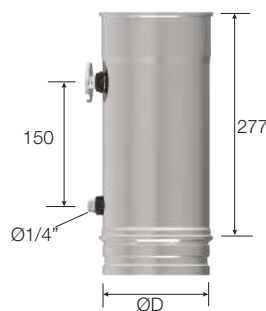

Pirómetro | Pyrometer | Pyromètre



Ref.	2500297
€ U.	31,60 1

0-500°C

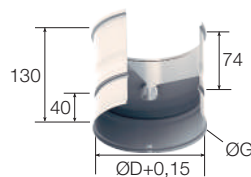

**Alternativas de montaje de la base inicial**  
Alternative floor base mounting  
*Possibilités de montage de la plaque de départ au sol*

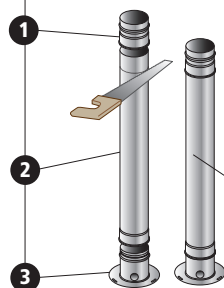

**Montaje | Mounting | Montage 1**  
Con tubo recortable | With cut-out piping | Avec tuyau recoupable

El tubo recortable puede ser cortado a medida para que encaje perfectamente entre el suelo y la te de conexión a la caldera.  
The cut-out piping can be cut to size for correct fitting between the floor and the boiler connection "T" Piece  
*L'élément recoupable peut être coupé sur mesure pour s'emboîter parfaitement entre le sol et le té de raccordement à la chaudière.*

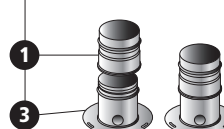

**Montaje | Mounting | Montage 2**  
Sin tubo recortable  
Without cut-out piping  
*Sans élément recoupable*

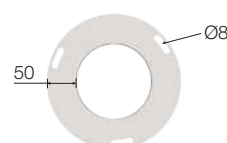

### Soporte forjado | Ceiling support | Plaque plancher



		ØD mm									
		80	100	110	125	130	150	180	200	230	250
AISI 304	Ref.	2700974	2700967	4022028	4013905	2700968	2700969	2700970	2700971	4022328	2700972
	€ U.	73,10	75,60	77,60	82,60	83,70	87,35	92,30	101,00	114,15	134,15
AISI 316L	Ref.	4016373**	4016374**	4022326	4016375	4016376	4016377	4016378	4016379	4022327	4016380
	€ U.	85,40	91,05	93,00	94,95	96,25	100,45	106,20	116,15	131,20	154,30
Medidas   Measurements   Mesures											
□ A		330	350	360	375	380	400	430	450	480	500

### Soporte forjado SP - DP | SW - DW Ceiling support | Plaque plancher SP - DP



		ØD mm									
		80	100	110	125	130	150	180	200	230	250
AISI 304	Ref.	4013071	4015135	-	4013970	4009216	4007590	4007591	4007592	-	4011056
	€ U.	92,00	93,70	-	104,45	106,65	112,50	135,95	143,75	-	192,70
AISI 316L	Ref.	4700730**	4016395**	-	4016396	4016399	4016400	4016401	4016402	-	4016403
	€ U.	107,55	112,90	-	124,95	132,60	140,90	162,35	174,95	-	221,60
Medidas   Measurements   Mesures											
□ A		330	350	360	375	380	400	430	450	480	500

### Terminal obra ventilado con collarín | Ventilated end piece with storm collar | Solin toit plat ventilé avec collerette



		ØD mm									
		80	100	110	125	130	150	180	200	230	250
AISI 304	Ref.	4019701	4019705	4019707	4020159	4019708	4019709	4019710	4019711	4020160	4019712
	€ U.	103,65	104,65	110,95	112,45	114,50	120,30	134,60	137,55	147,65	162,95
□ A		395	395	395	395	395	395	450	450	450	495
ØDp		125	145	145	170	175	195	222	242	272	292

### Terminal obra | End piece | Solin toit



		ØD mm									
		80	100	110	125	130	150	180	200	230	250
AISI 304	Ref.	4020097	4020098	4020099	4022440	4020100	4020101	4020102	4020103	4022433	4020104
	€ U.	74,75	75,50	76,05	83,40	87,35	88,60	95,40	96,65	104,20	113,10
Medidas   Measurements   Mesures											
□ A		390	390	390	390	390	390	390	450	450	495

### Sombrero bicónico | Jet cap | Chapeau jet



		ØD mm					
		450	500	550	600	650	700
AISI 304	Ref.	4040191	4040192	4040193	4040194	4040195	4040196
	€ U.	2.182,40	2.329,00	2.484,75	2.643,20	2.867,90	3.154,60
Medidas   Measurements   Mesures							
ØDs		540	600	660	720	780	840
ØDc		790	885	980	1075	1140	1225
H		867	947	1027	1107	1188	1268

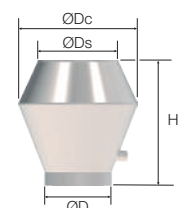

Ref.	2700969	Unidades de embalaje Packing units Unités d'emballage
€ U.	87,35	



**Abrazadera de unión incluida en todas las piezas.**  
Connection bracket included in all parts.  
*Collier de fixation inclus dans toutes les pièces.*



**Junta incluida.**  
Gasket included. **\*\* Ø80 - 100**  
*Joint inclus.*

300	350	400
2700973	4022329	4022330
157,70	176,00	197,80
4016381	4016382	4022331
181,30	202,40	227,45
550	600	650

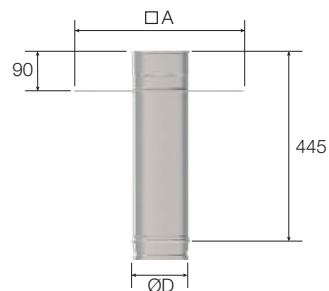

300	350	400
4015137	4015138	4015170
264,20	296,10	337,30
4016253	4016256	4015171
303,90	340,40	387,80
550	600	650

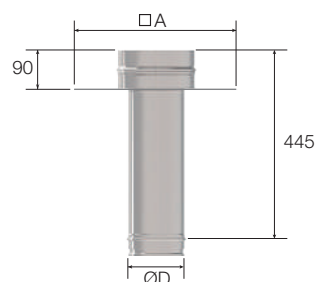

300	350	400
4019713	4019714	4019728
175,70	204,30	252,70
495	495	600
342	392	442

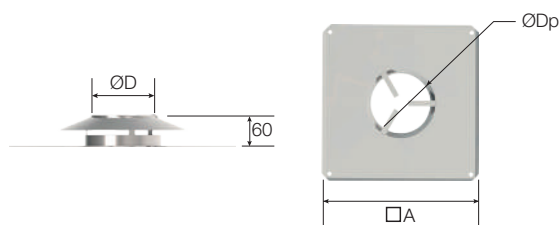

300	350	400
4020105	4020106	4019729
129,50	151,65	168,35
495	495	495



2

### Sombrero antilluvia | Rain cap | *Chapeau pare-pluie*



\*Opción antipájaros  
\*Bird guard option  
\*Option anti-volatile

		ØD mm									
		80	100	110	125	130	150	180	200	230	250
AISI 304	Ref.	2700476	2700045	4022481	4013733	2700132	2700200	2700251	2700309	4011596	2700369
	€ U.	40,75	43,15	43,55	43,65	44,30	46,20	54,85	61,65	74,90	85,35
AISI 316L	Ref.	4600330**	4600331**	4022482	4016429	4016430	4014987	4016431	4014988	4020676	4014989
	€ U.	56,20	59,50	60,00	60,20	61,00	62,30	72,95	80,60	100,10	109,10
AISI 316L*	Ref.	4016850**	4016851**	-	4016852	4016853	4016854	4016855	4016856	-	4016857
	€ U.	75,95	79,25	-	81,55	82,70	85,75	98,95	108,35	-	141,10
Medidas   Measurements   Mesures											
V		106	106	106	106	106	106	106	106	106	143
ØDp		250	250	300	300	300	350	350	400	450	

### Sombrero antiretorno | Non-return cap | *Chapeau anti-refoulement*



		ØD mm									
		80	100	110	125	130	150	180	200	230	250
AISI 304	Ref.	2700477	2700046	4022483	4013909	2700133	2700201	2700252	2700310	4011751	2700370
	€ U.	63,20	70,20	72,10	73,35	74,35	90,45	102,20	118,25	130,35	140,95
AISI 316L	Ref.	4600320**	4600321**	4022484	4016439	4016440	4016441	4016442	4016443	4022487	4016444
	€ U.	88,40	97,65	101,35	103,15	105,10	127,20	143,75	162,40	183,25	198,25
Medidas   Measurements   Mesures											
U		142	142	142	142	142	142	142	200	200	200
V		182	182	182	182	182	182	182	240	240	240
ØDp		180	200	210	230	230	250	280	350	380	400

### Sombrero giratorio | Wind directional cap | *Chapeau aspirateur*



		ØD mm							
		125	130	150	180	200	250	300	350
AISI 304	Ref.	4013734	2500319	2500320	2500321	2500322	2500323	2700415	2700437
	€ U.	248,05	251,25	270,30	311,75	321,65	353,25	470,65	602,40
Medidas   Measurements   Mesures									
L		372	372	392	392	442	442	462	532
V		415	415	435	435	485	485	505	575
ØA		175	175	205	205	250	250	260	290



Unión para tubo Simple Pared | Single-wall piping connection | Raccord pour tuyau Simple Paroi

### Sombrero salida libre | Outlet cone | *Cône de finition*



		ØD mm									
		80	100	110	125	130	150	180	200	230	250
AISI 304	Ref.	2700479	2700048	4022485	4013736	2700134	2700202	2700253	2700311	4022488	2700371
	€ U.	43,50	48,10	51,35	55,00	59,60	66,45	76,05	84,80	93,60	103,90
AISI 316L	Ref.	4600340**	4600341**	4022486	4016455	4014504	4015048	4016456	4014368	4022489	4013701
	€ U.	58,65	64,90	69,25	78,15	86,00	89,80	101,45	106,00	110,15	119,50

### Sombrero salida vertical | Vertical outlet cap | *Chapeau sortie verticale*



		ØD mm									
		80	100	110	125	130	150	180	200	230	250
AISI 304	Ref.	4040062	4040063	-	4040065	4040066	2700659	2700658	2700657	-	2700656
	€ U.	48,25	49,60	-	51,10	54,05	60,50	72,95	89,10	-	125,20
AISI 316L	Ref.	4040069**	4040070**	-	4040072	4040073	4016477	4016478	4016480	-	4016481
	€ U.	65,10	66,95	-	68,95	72,90	81,60	98,35	120,25	-	162,75
Medidas   Measurements   Mesures											
L		283									
H		78	88	88	90	90	90	95	150	153	179

### Sombrero salida horizontal | Horizontal outlet cap | *Chapeau sortie horizontale* 500 mm



		ØD mm					
		80	100	110	125	130	150
AISI 304	Ref.	2700478	2700047	4023531	4013735	4007269	4040060
	€ U.	36,30	37,75	49,15	61,80	68,85	89,30
AISI 316L	Ref.	4600350**	4016484**	4023533	4016485	4016486	4040061
	€ U.	46,80	48,55	61,45	77,30	86,05	111,70

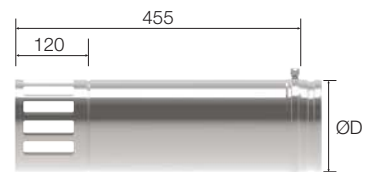

### Sombrero pico flauta | Flute peak cap | *Chapeau de flûte*



		ØD mm									
		80	100	110	125	130	150	180	200	230	250
AISI 316L	Ref.	4007540**	4007541**	-	4007543	4007544	4007546	4007548	4010230	-	4014635
	€ U.	61,05	64,10	-	68,50	70,50	72,35	85,35	90,80	-	126,25

Ref.	2700202	Unidades de embalaje Packing units Unités d'emballage
€ U.	66,45 <sup>1</sup>	



**Abrazadera de unión incluida en todas las piezas.**  
Connection bracket included in all parts.  
*Collier de fixation inclus dans toutes les pièces.*



**Junta incluida.**  
Gasket included. **\*\* ø80 - 100**  
*Joint inclus.*

300	350	400	450	500	550	600	650	700
2700414	2700586	2700880	4029567	4029686	4029841	4030028	4030114	4040227
<b>120,40</b> <sup>1</sup>	<b>125,20</b> <sup>1</sup>	<b>163,65</b> <sup>1</sup>	<b>236,45</b> <sup>1</sup>	<b>309,95</b> <sup>1</sup>	<b>339,95</b> <sup>1</sup>	<b>437,40</b> <sup>1</sup>	<b>474,50</b> <sup>1</sup>	<b>530,60</b> <sup>1</sup>
4015435	4016432	4016433	4029630	4029734	4029901	4030052	4030149	4040228
<b>153,95</b> <sup>1</sup>	<b>173,35</b> <sup>1</sup>	<b>205,40</b> <sup>1</sup>	<b>275,85</b> <sup>1</sup>	<b>356,40</b> <sup>1</sup>	<b>391,00</b> <sup>1</sup>	<b>503,10</b> <sup>1</sup>	<b>545,65</b> <sup>1</sup>	<b>610,20</b> <sup>1</sup>
4016858	-	-	-	-	-	-	-	-
<b>190,20</b> <sup>1</sup>	-	-	-	-	-	-	-	-

143	143	143	150	200	200	200	300	300
500	550	600	800	900	990	990	1300	1300

300	350	400	450	500	550	600	650	700
4010181	2700882	2700595	4040231	4040232	4040233	4040234	4040235	4040236
<b>187,15</b> <sup>1</sup>	<b>207,80</b> <sup>1</sup>	<b>263,60</b> <sup>1</sup>	<b>312,85</b> <sup>1</sup>	<b>358,45</b> <sup>1</sup>	<b>493,45</b> <sup>1</sup>	<b>533,35</b> <sup>1</sup>	<b>617,95</b> <sup>1</sup>	<b>737,90</b> <sup>1</sup>
4016445	4016446	4016447	4040237	4040238	4040239	4040240	4040241	4040242
<b>251,25</b> <sup>1</sup>	<b>285,50</b> <sup>1</sup>	<b>324,45</b> <sup>1</sup>	<b>343,80</b> <sup>1</sup>	<b>439,30</b> <sup>1</sup>	<b>597,10</b> <sup>1</sup>	<b>632,30</b> <sup>1</sup>	<b>720,30</b> <sup>1</sup>	<b>845,15</b> <sup>1</sup>

200	200	200	500	500	500	500	500	500
240	240	240	595	595	595	595	595	595
450	500	550	650	700	750	800	850	900

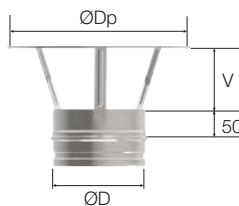

**Sombrero giratorio universal | Universal wind-directional cap | Chapeau aspirateur universel**



ØD mm	125	130	150	180	200	250	300	350
AISI 304 Ref.	-	3032088	3034036	3034041	3034042	3034043	3034044	3034045
€ U.	-	<b>221,05</b> <sup>1</sup>	<b>231,75</b> <sup>1</sup>	<b>265,45</b> <sup>1</sup>	<b>282,25</b> <sup>1</sup>	<b>307,60</b> <sup>1</sup>	<b>419,90</b> <sup>1</sup>	<b>559,60</b> <sup>1</sup>
Medidas   Measurements   Mesures								
V	-	287	307	307	357	357	377	447
ØA	-	175	205	205	250	250	260	290

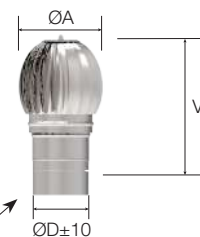

Unión para tubo liso | Smooth piping connection | Raccord pour tuyau lisse

300	350	400	450	500	550	600	650	700
2700593	2700438	4007438	4029569	4029692	4029843	4030030	4030117	4040129
<b>137,55</b> <sup>1</sup>	<b>172,90</b> <sup>1</sup>	<b>179,40</b> <sup>1</sup>	<b>196,20</b> <sup>1</sup>	<b>231,50</b> <sup>1</sup>	<b>289,30</b> <sup>1</sup>	<b>385,10</b> <sup>1</sup>	<b>452,90</b> <sup>1</sup>	<b>561,50</b> <sup>1</sup>
4015042	4013101	4016457	4029632	4029736	4029903	4030054	4030151	4040130
<b>158,20</b> <sup>1</sup>	<b>190,20</b> <sup>1</sup>	<b>197,35</b> <sup>1</sup>	<b>258,25</b> <sup>1</sup>	<b>289,30</b> <sup>1</sup>	<b>361,60</b> <sup>1</sup>	<b>462,15</b> <sup>1</sup>	<b>520,90</b> <sup>1</sup>	<b>645,75</b> <sup>1</sup>



300	350	400
4011811	4015665	4019424
<b>148,20</b> <sup>1</sup>	<b>165,45</b> <sup>1</sup>	<b>199,45</b> <sup>1</sup>
4016482	4016483	4040077
<b>200,10</b> <sup>1</sup>	<b>223,35</b> <sup>1</sup>	<b>269,25</b> <sup>1</sup>



445		
185	239	255

300	350	400	450	500	550	600	650	700
4012570	4020915	4007550	4007557	4007558	4007559	4007560	4007561	4007562
<b>144,65</b> <sup>1</sup>	<b>161,70</b> <sup>1</sup>	<b>223,90</b> <sup>1</sup>	<b>242,50</b> <sup>1</sup>	<b>260,60</b> <sup>1</sup>	<b>334,55</b> <sup>1</sup>	<b>361,10</b> <sup>1</sup>	<b>415,30</b> <sup>1</sup>	<b>498,35</b> <sup>1</sup>

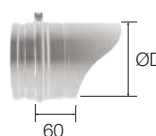

2

### Adaptador caldera | Boiler adapter | *Adaptateur chaudière*



		ØD mm									
		80	100	110	125	130	150	180	200	230	250
AISI 304	Ref.	2700463	2700031	4022439	4013911	2700116	2700185	2700237	2700291	4022443	2700732
	€ U.	17,25 4	19,20 4	19,85 4	20,10 4	21,90 4	24,80 4	34,60 4	39,95 4	42,90 1	46,80 1
AISI 316L	Ref.	4010848	4016593	4022442	4016594	4016595	4016596	4016597	4016598	4022445	4016599
	€ U.	23,75 4	26,55 4	27,35 4	27,80 4	28,15 4	30,05 4	37,95 4	46,95 4	54,75 1	59,75 1

### Adaptador caldera antihollín | Anti-soot boiler adapter | *Adaptateur chaudière anti-bistre*



		ØD mm									
		80	100	110	125	130	150	180	200	230	250
AISI 316L	Ref.	-	4025397	4025399	4025400	4025401	4025403	4025406	4025407	4025408	4025409
	€ U.	-	28,35 4	29,75 4	30,70 4	30,95 4	32,50 4	46,60 4	48,15 4	56,25 1	63,25 1
Medidas   Measurements   Mesures											
ØDi		-	80	90	105	110	132	158	178	208	228
ØDe		-	102	112	127	132	152	182	202	232	252

### Adaptador SP - DP | SW - DW Adapter | *Adaptateur SP - DP*



		ØD mm									
		80	100	110	125	130	150	180	200	230	250
AISI 304	Ref.	4007484	2700013	4022451	4013792	2700092	2700160	2700213	2700262	-	2700322
	€ U.	36,80 1	38,40 1	43,00 1	45,60 1	46,15 1	50,05 1	62,40 1	66,10 1	-	83,15 1
AISI 316L	Ref.	4700545**	4700546**	4022452	4016602	4015766	4014568	4015915	4014579	-	4014569
	€ U.	47,30 1	53,30 1	58,70 1	62,20 1	63,10 1	70,20 1	84,75 1	90,40 1	-	105,45 1

### Adaptador Macho SP - Pestaña SP | SW male - SW lip adapter | *Adaptateur Mâle SP - bord tombé SP \**



		ØD mm									
		80	100	110	125	130	150	180	200	230	250
AISI 316L	Ref.	4040640	4040641	4040642	4040643	4040644	4040645	4040646	4040647	-	4040648
	€ U.	19,20 1	21,20 1	22,00 1	23,30 1	23,75 1	25,40 1	28,05 1	30,15 1	-	35,40 1

### Adaptador Hembra SP - Pestaña SP | SW female - SW lip adapter | *Adaptateur Femelle SP - bord tombé SP*



		ØD mm									
		80	100	110	125	130	150	180	200	230	250
AISI 316L	Ref.	4040600	4040601	4040602	4040603	4040604	4040605	4040606	4040607	-	4040608
	€ U.	15,00 1	17,05 1	17,70 1	19,00 1	19,20 1	20,55 1	23,10 1	24,95 1	-	29,95 1

### Adaptador Macho - Macho | Male - Male Adapter | *Adaptateur Mâle - Mâle*



		ØD mm									
		80	100	110	125	130	150	180	200	230	250
AISI 304	Ref.	2700465	2700033	4022478	4013912	2700119	2700188	2700239	2700293	2700525	2700352
	€ U.	11,80 4	13,75 4	17,00 4	17,75 4	19,30 4	21,95 4	25,75 4	26,65 4	27,45 1	30,35 1
AISI 316L	Ref.	4010845**	4016603**	4022479	4016604	4016605	4014994	4016606	4016607	4016608	4016609
	€ U.	16,20 4	19,05 4	23,30 4	24,45 4	24,75 4	26,50 4	28,40 4	30,25 4	34,95 1	38,85 1

### Adaptador Hembra - Hembra | Female - Female Adapter | *Adaptateur Femelle - Femelle*



		ØD mm									
		80	100	110	125	130	150	180	200	230	250
AISI 304	Ref.	2700464	2700032	4022476	4013913	2700118	2700187	2700238	2700292	4014532	2700351
	€ U.	12,10 4	14,40 4	15,15 4	15,35 4	16,75 4	20,40 4	24,35 4	26,65 4	31,20 1	33,15 1
AISI 316L	Ref.	4009592	4015046	4022477	4016612	4016613	4014990	4016614	4016615	4022480	4016616
	€ U.	16,65 4	19,95 4	20,95 4	21,20 4	21,55 4	24,60 4	26,85 4	32,05 4	39,80 1	42,25 1

### Paso mural | Wall bushing | *Traversée de mur*



		ØD mm									
		80	100	110	125	130	150	180	200	230	250
AISI 316L	Ref.	4019781	4019782	4019783	-	4019784	4019785	4019786	4019787	-	4019788
	€ U.	52,85 4	56,85 4	57,40 4	-	57,95 4	59,75 4	63,90 4	64,70 4	-	70,40 1



Ref.	2700185	Unidades de embalaje Packing units Unités d'emballage
€ U.	24,80 <b>4</b>	



**Abrazadera de unión incluida en todas las piezas.**  
Connection bracket included in all parts.  
*Collier de fixation inclus dans toutes les pièces.*



**Junta incluida.**  
Gasket included. **\*\* ø80 - 100**  
*Joint inclus.*

300	350	400	450	500	550	600	650	700
2700399	4030562	4029553	4029554	4029675	4029813	4030013	4030104	4040135
<b>70,85</b> 1	<b>82,15</b> 1	<b>93,95</b> 1	<b>105,90</b> 1	<b>129,45</b> 1	<b>146,90</b> 1	<b>172,45</b> 1	<b>205,70</b> 1	<b>249,55</b> 1
4016600	4030563	4029555	4029556	4029703	4029853	4030042	4030127	4040136
<b>90,35</b> 1	<b>100,20</b> 1	<b>112,45</b> 1	<b>114,80</b> 1	<b>140,30</b> 1	<b>172,95</b> 1	<b>207,55</b> 1	<b>247,60</b> 1	<b>300,45</b> 1

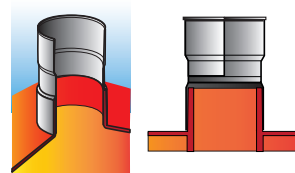
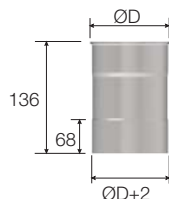

2

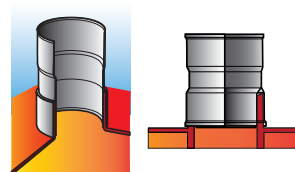
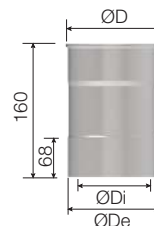

300	350	400	450	500	550	600	650
2700825	4008960	4027340	4029558	4029678	4029817	4030015	4030106
<b>132,15</b> 1	<b>161,25</b> 1	<b>174,60</b> 1	<b>193,65</b> 1	<b>222,55</b> 1	<b>277,40</b> 1	<b>332,30</b> 1	<b>382,80</b> 1
4023385	4014405	4028927	4029616	4029705	4029865	4030044	4030134
<b>167,80</b> 1	<b>204,70</b> 1	<b>221,75</b> 1	<b>237,10</b> 1	<b>273,80</b> 1	<b>323,15</b> 1	<b>381,00</b> 1	<b>426,15</b> 1

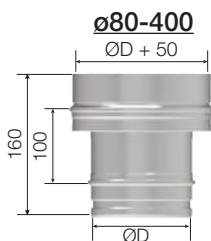

**ø450 - 700**

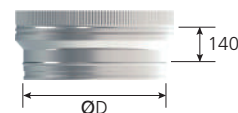

300	350	400
4040649	4040650	4040651
<b>41,10</b> 1	<b>46,95</b> 1	<b>52,60</b> 1

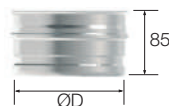

**\* Incluye Abrazadera unión tornillo**  
Connection bracket, screwed included  
*Collier de fixation à vis inclus*

300	350	400
4040609	4040610	4040611
<b>35,25</b> 1	<b>40,25</b> 1	<b>45,35</b> 1

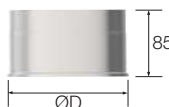

300	350	400	450	500	550	600	650	700
2700401	4008295	4011679	4040149	4040150	4040151	4040152	4040153	4040154
<b>50,40</b> 1	<b>65,85</b> 1	<b>70,95</b> 1	<b>83,45</b> 1	<b>102,70</b> 1	<b>126,60</b> 1	<b>152,80</b> 1	<b>181,30</b> 1	<b>219,90</b> 1
4016610	4016611	4040015	4040155	4040156	4040157	4040158	4040159	4040160
<b>64,35</b> 1	<b>88,00</b> 1	<b>103,50</b> 1	<b>111,45</b> 1	<b>135,95</b> 1	<b>169,25</b> 1	<b>203,90</b> 1	<b>241,85</b> 1	<b>293,95</b> 1

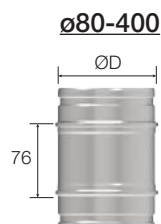

**ø450 - 700**

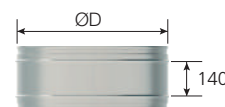

300	350	400	450	500	550	600	650	700
2700400	2700431	4009297	4040137	4040138	4040139	4040140	4040141	4040142
<b>49,00</b> 1	<b>62,60</b> 1	<b>70,75</b> 1	<b>77,70</b> 1	<b>96,30</b> 1	<b>118,70</b> 1	<b>143,20</b> 1	<b>170,05</b> 1	<b>206,20</b> 1
4016617	4016618	4040016	4040143	4040144	4040145	4040146	4040147	4040148
<b>62,35</b> 1	<b>83,70</b> 1	<b>98,90</b> 1	<b>104,60</b> 1	<b>127,50</b> 1	<b>158,60</b> 1	<b>191,25</b> 1	<b>226,75</b> 1	<b>275,65</b> 1

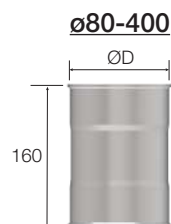

**ø450 - 700**

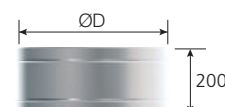

300	350	400
4019789	4019790	4019791
<b>91,05</b> 1	<b>100,75</b> 1	<b>128,60</b> 1

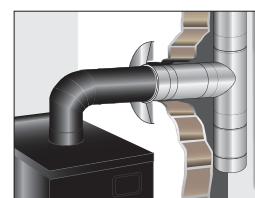
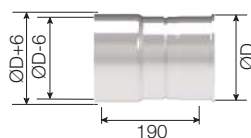

# SP

## Simple Pared | Single Wall | Simple Pared

Ø80-700

Aumento Augmentation adapter Augmentation	ø	80	100	125	Reducción Reduction Adapter Réduction	ø	80	100	125	
	80		4022589**	4022590		4022591	4022592**	208,80	221,10	233,80
	100	4022590	205,15	233,80		4022591	233,80	233,80		
	125	217,20	221,25	4022594	217,20	221,25				

Aumento - Reducción | Augmentation adapter - Reduction adapter | Augmentation · Réduction

Ø	80	100	110	125	130	150	180	200	230	250	300	350	400	450	500	550	600	650	700
80		4022589** 58,95	4022591 60,90	4022598 63,15	4022607 64,95														
100	4600404** 54,85		4022590 63,65	4022596 65,25	4015436 65,70	4022631 69,70	4022658 74,90												
110	4022510 56,35	4022513 65,25		4022593 66,90	4022602 67,20	4022629 71,70	4022657 75,35												
125	4020560 56,70	4022514 65,30	4022517 66,70		4022599 68,55	4022628 73,00	4022655 80,90	4022663 90,50											
130	4014505 58,35	4015045 65,60	4022520 67,15	4018342 67,00		4015653 73,70	4022651 81,15	4022662 95,50	4022674 97,50										
150	4017721 64,90	4022516 67,80	4022525 69,20	4022528 70,45	4022533 71,70		4015654 84,80	4022660 97,05	4022671 98,05	4018425 99,65									
180				4022530 70,60	4022554 76,90	4022564 88,15		4015655 99,25	4022668 102,30	4022678 103,15									
200		4030132 89,90		4022531 79,70	4022555 80,60	4015882 91,65	4022571 97,80		4022664 106,40	4015656 109,35	4022683 125,45								
230							4022572 102,55	4022575 105,90		4022676 114,05	4022681 126,50								
250						4022566 108,15	4022573 109,75	4022276 111,80	4022578 121,45		4015657 127,95	4022694 150,45	4022685 168,80						
300							4022574 121,25	4022576 126,25	4022579 130,65	4022581 131,45		4022687 155,35	4022686 174,50	4040768 258,40					
350								4022577 135,10	4022580 138,60	4022582 143,75	4022583 149,25		4022697 180,60	4040769 244,35	4040770 279,10				
400									4009573 196,25	4011762 203,80	4008962 211,70		4040771 236,75	4040772 276,15	4040773 302,80				
450										4040762 285,65	4040763 274,05	4040750 220,25		4040774 255,55	4040775 290,15	4040776 331,95			
500											4040764 294,50	4040751 259,60	4040753 237,65		4040777 263,95	4040778 319,75	4040779 354,15		
550												4040752 301,10	4040754 269,95	4040756 245,45		4040780 288,85	4040781 337,40	4040782 437,40	
600													4040755 308,70	4040757 297,30	4040759 268,65		4040783 306,90	4040784 424,10	
650														4040758 329,35	4040760 313,85	4040761 285,50		4040785 411,05	
700															4040765 411,00	4040766 389,65	4040767 353,55		



L mm	øDi mm																		
	80	100	110	125	130	150	180	200	230	250	300	350	400	450	500	550	600	650	700
80		141	159	187	197														
100	141		110	150	159	197	248												
110	159	110		110	110	178	230												
125	187	150	110		110	150	202	240											
130	197	159	110	110		141	193	230	286										
150	234	197	178	150	110		155	193	249	286									
180				202	193	155		141	197	234									
200		280		240	230	193	141		160	197	290								
230							197	160		141	234								
250						153	234	197	141		197	290	383						
300							164	154	234	197		234	287	180					
350								179	164	154	234		197	155	180				
400										179	154	197	130	156	180				
450											186	161	136	134	160	185			
500												186	162	134	134	160	185		
550													186	160	134	134	160	185	
600														185	160	134	134	160	
650															160	160	134	134	
700																185	160	134	

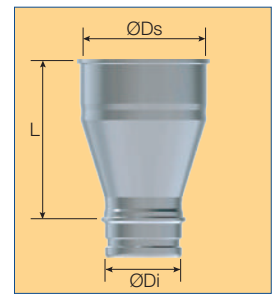
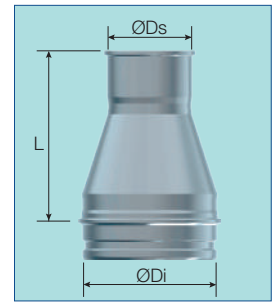

 Abrazadera de unión incluida en todas las piezas.  
Connection bracket included in all parts.  
Collier de fixation inclus dans toutes les pièces.

 Junta incluida.  
Gasket included.  
Joint inclus. **\*\* ø80 - 100**



Material: | Material: | Matériel : **AIISI 316L**

Unidades de embalaje: | Packing units: | Unités d'emballage : **1**

**Aumento y reducción excéntrica** | Eccentric augmentation adapter and reduction adapter | *Augmentation et réduction excentrées*

Ø	80	100	110	125	130	150	180	200	230	250	300	350	400	450	500	550	600	650	700	
80		4029179**	4029180	4029182	4029183															
		73,70	76,10	78,90	81,25															
100	4028780**			4029186	4029187	4029192	4029194													
	68,50			81,55	82,15	87,10	93,60													
110	4029062			4029195	4029196	4029200	4029206													
	70,50			83,60	84,00	89,65	94,15													
125	4029063	4029067	4029079			4029210	4029212	4029213												
	70,85	81,60	83,30			91,25	101,20	113,10												
130	4029064	4029068	4029081			4029215	4029217	4029218												
	72,90	82,00	83,90			92,10	101,40	119,40												
150	4029066	4029070	4029084	4029088	4029093		4029224	4029225	4029226	4029227										
	81,20	84,75	86,45	88,10	89,60		106,00	121,35	122,45	124,55										
180				4029090	4029115	4029123		4029232	4029233	4029234										
				88,25	96,10	110,05		124,05	127,80	128,90										
200				4029091	4029116	4029124	4029136		4029235	4029236	4029237									
				99,55	100,65	114,55	122,35		132,80	136,55	156,80									
230						4029125	4029137	4029139		4029239	4029240									
						125,90	128,05	132,35		142,50	158,05									
250						4029126	4029138	4029140	4029145		4029242	4029243	4029244							
						135,15	137,15	139,65	151,80		159,90	188,10	211,00							
300						4029141	4029142	4029146	4029148		4029245	4029246	4040815							
						151,50	157,80	163,25	164,30		194,20	218,05	323,00							
350						4029144	4029147	4029173	4029176		4029247	4040816	4040817							
						168,80	173,30	179,60	186,45		225,70	305,45	348,90							
400										4029175	4029177	4029178		4040803	4040804	4040806				
										245,30	254,80	264,65		295,20	345,10	377,45				
450											4040797	4040798	4040786		4040805	4040807	4040809			
											357,15	342,55	274,60		318,65	361,90	413,80			
500												4040799	4040266	4040787		4040808	4040810	4040812		
												368,15	323,75	296,30		329,00	398,60	441,55		
550													4040788	4040789	4040790		4040811	4040813	4040819	
													376,40	336,60	306,00		360,15	420,75	546,80	
600														4040791	4040792	4040793		4040814	4040818	
														384,90	370,85	335,00		382,70	530,20	
650															4040794	4040795	4040796		4040820	
															410,65	391,25	355,95		513,85	
700																4040800	4040801	4040802		
																513,75	487,00	441,85		



**2**

L mm	øDi mm																			
	80	100	110	125	130	150	180	200	230	250	300	350	400	450	500	550	600	650	700	
80		121	129	147	147															
100	121			125	129	147	171													
110	129			117	121	138	162													
125	147	125	117			125	149	167												
130	147	129	121			121	145	162												
150	164	147	138	125	121		128	145	171	188										
180				149	145	128		121	147	164										
200				167	162	145	121		130	147	190									
230						171	147	130		121	164									
250						188	164	147	121		147	190	233							
300							208	190	164	147		147	207	235						
350								233	207	190	147		147	192	235					
400									233	190	147		149	192	235					
450										235	192	149		153	196	240				
500											235	192	153		153	197	240			
550												235	197	153		153	197	240		
600													240	197	153		153	197		
650														240	197	153		153		
700															240	197	153			

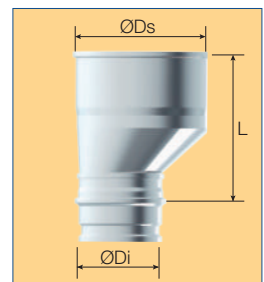
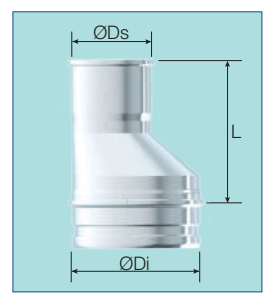

### Abrazadera mural interior | Interior wall bracket | Collier support mural intérieur \*



Ø80-400

Ø450-700

ØD mm		80	100	110	125	130	150	180	200	230	250
AISI 304	Ref.	2500046	2500037	5003875	4013902	2500038	2500039	2500040	2500041	5001351	2500042
	€ U.	10,30 6	11,80 6	13,10 6	13,50 6	13,90 6	14,75 6	15,90 6	17,75 6	24,10 2	25,60 2
Medidas   Measurements   Mesures											
A		120	120	120	150	150	150	190	190	190	230

\* Opción regulable: añadir Prolongación mural (ver pág. 132)  
Adjustable option: add Wall extension (see page 132)  
Option réglable: ajouter Rallonge murale (voir page 132)

### Abrazadera pared regulable | Adjustable wall bracket | Collier mural réglable \*



ØD mm		80	100	110	125	130	150	180	200	230	250
AISI 304	Ref.	4600700	4600701	5003876	4600702	4600707	4600703	4600705	4600704	4600708	4600706
	€ U.	12,95 1	14,75 1	15,90 1	16,45 1	17,05 1	19,30 1	23,65 1	29,00 1	34,50 1	38,10 1
Medidas   Measurements   Mesures											
A		156	156	156	186	186	186	226	226	226	266

\* Opción regulable: añadir Prolongación mural (ver pág. 132)  
Adjustable option: add Wall extension (see page 132)  
Option réglable: ajouter Rallonge murale (voir page 132)

### Abrazadera atornillar | Screwed bracket | Collier à vis



ØD mm		80	100	110	125	130	150
AISI 304	Ref.	2500026	2500023	5003877	4013908	2500024	2500025
	€ U.	8,65 1	8,90 1	9,30 1	9,50 1	9,55 1	9,80 1

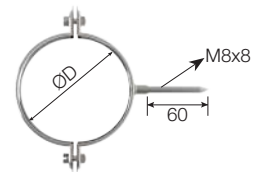

### Abrazadera de vientos | Roof brace band | Collier pour hauban



ØD mm		80	100	110	125	130	150	180	200	230	250
AISI 304	Ref.	2700467	2700035	4019537	4013907	2700121	2700190	2700241	2700295	2700214	2700354
	€ U.	28,65 3	29,45 3	29,75 3	30,15 3	30,35 3	31,60 3	37,70 3	39,80 3	40,75 1	49,15 1

### Abrazadera descenso | Chimney-lowering bracket | Collier de descente



ØD mm		80	100	110	125	130	150	180	200	230	250
AISI 304	Ref.	4035095	4035096	-	4035111	4035097	4035098	4035099	4035100	4035101	4035102
	€ U.	46,20 1	47,55 1	-	49,35 1	50,70 1	52,35 1	55,30 1	58,45 1	59,25 1	59,35 1

### Abrazadera araña | Spider bracket | Bride araignée



ØD mm		80	100	110	125	130	150	180	200	230	250
AISI 304	Ref.	4008372	4018448	4018693	4018695	4013533	4009721	4012491	4016687	4027251	4025629
	€ U.	48,60 1	50,05 1	51,45 1	51,95 1	53,30 1	55,10 1	58,15 1	61,45 1	62,40 1	62,50 1

### Abrazadera de suspensión horizontal | Horizontal suspension bracket | Collier de suspension horizontale



ØD mm		80	100	110	125	130	150	180	200	230	250
AISI 304	Ref.	-	-	-	-	-	-	5005630	5005631	5005632	5005633
	€ U.	-	-	-	-	-	-	13,50 1	13,90 1	14,10 1	14,20 1

\* No incluye varillas de fijación ni tornillería necesaria | Fixing rods and necessary screws not included |  
Tiges de fixation et vis nécessaires non incluses

Ref.	2500039	Unidades de embalaje
€ U.	14,75	Packing units
	6	Unités d'emballage

300	350	400	450	500	550	600	650	700
2500043	2500510	2500044	4035019	4035066	4035067	4035068	4035069	4035070
32,85	44,95	63,60	104,00	117,10	128,50	137,85	150,55	164,05
230	300	300	-	-	-	-	-	-

300	350	400
4600709	4600710	4600711
46,00	46,20	59,25
266	336	336

300	350	400	450	500	550	600	650	700
2700403	2700323	2700418	4014608	4014609	4014610	4014611	4014612	4014613
67,75	75,25	85,70	95,20	96,95	101,60	106,30	114,40	123,15

300	350	400	450	500	550	600	650	700
4035103	4035104	4035105	4040417	4040418	4040419	4040420	4040421	4040422
60,00	67,65	75,00	83,90	88,00	92,80	97,65	101,30	108,50

300	350	400	450	500	550	600	650	700
4016411	4016412	4016414	4040203	4040204	4040205	4040206	4040207	4040208
63,15	63,50	66,90	73,00	76,60	80,70	85,05	88,15	94,40

300	350	400	450	500	550	600	650	700
5005634	5005635	5005636	5005637	5005638	5005639	5005640	5005641	5005642
17,10	19,80	22,30	25,45	26,00	28,40	30,80	33,40	35,00

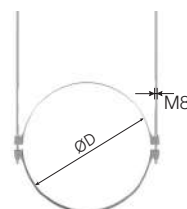
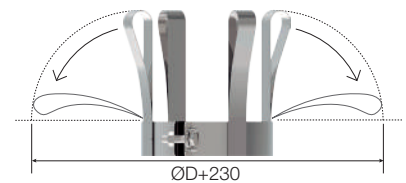
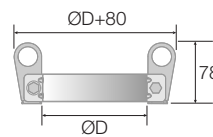
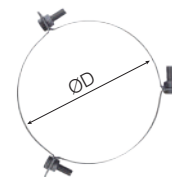
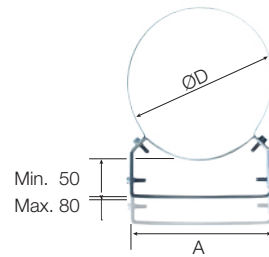
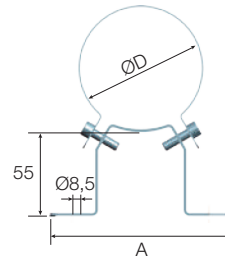

### Soporte mural intermedio | Intermediate wall support | Support mural intermédiaire \*



ØD mm		80	100	110	125	130	150	180	200	230	250
AISI 304	Ref.	4020313	4020315	4022425	4020316	4020317	4020318	4020319	4020320	4022429	4020321
	€ U.	70,50	76,35	83,45	93,95	94,50	95,40	103,40	125,45	126,60	128,05
AISI 316L	Ref.	4023689**	4023690**	4023691	4023692	4023693	4023695	4023697	4023698	4023699	4023700
	€ U.	102,30	107,10	117,05	124,50	127,75	133,75	144,65	176,00	177,65	179,75

Medidas | Measurements | Mesures

	A	115	135	145	160	165	185	213	233	263	283
	B	195	215	225	240	245	265	293	313	343	363

\* No incluye escuadras | Square supports not included | Équerres de support non inclus

### Soporte mural universal | Universal wall support | Support mural universel \*

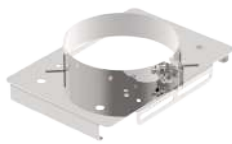

ØD mm		80	100	110	125	130	150	180	200	230	250
AISI 304	Ref.	-	-	-	4028317	4026049	4026050	4026051	4026052	4026053	4026054
	€ U.	-	-	-	80,35	81,40	86,10	93,70	101,75	111,00	119,20

Medidas | Measurements | Mesures

	A	-	-	-	165	165	185	213	233	263	283
	B	-	-	-	245	245	265	293	313	343	363

\* No incluye escuadras | Square supports not included | Équerres de support non inclus

### Escuadra de soporte (2 unidades) | Square support (2 units) | Équerre de support (2 unités)



		Pequeña* Small* Petit*	Mediana* Medium* Moyen*	Grande* Large* Grand*
AISI 304	Ref.	4019925	4019926	4019927
	€ Kit	70,65	94,25	122,35

Medidas | Measurements | Mesures

	L	245	360	515
	H	290	430	610

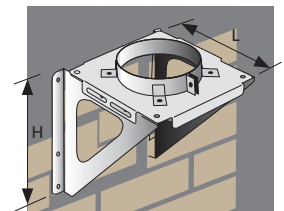

Escuadra con soporte mural  
Square with wall support  
Équerre avec support mural

\* Consultar el tamaño adecuado en la página 143 | Refer to the appropriate size on page 143 | Voir la taille appropriée à la page 143

### Escuadra de soporte reforzada (2 unidades) | Reinforced square support (2 units) | Équerre de support renforcé (2 unités)



		L	500 mm	750 mm	1000 mm
AISI 304	Ref.	5003914	5003915	5003916	
	€ U.	194,95	257,35	292,50	

Medidas | Measurements | Mesures

	H	310	470	600
--	---	-----	-----	-----

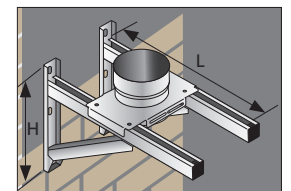

Escuadra reforzada con soporte mural  
Reinforced square with wall support  
Support renforcé avec support mural

\* Apto para Soporte mural universal e intermedio | Suitable for universal and intermediate wall supports | Convient pour le Support mural universel et intermédiaire

### Abrazadera de unión tornillo | Connection bracket, screwed | Collier de fixation à vis



ØD mm		80	100	110	125	130	150	180	200	230	250
AISI 304	Ref.	5003964	5003965	5003966	5004280	5003967	5003968	5003969	5003970	5003971	5003972
	€ U.	4,30	4,35	4,40	4,70	4,75	4,90	5,05	5,15	5,35	5,60

### Junta silicona | Silicone gasket | Joint silicone 200° C



ØD mm		80	100	110	125	130	150	180	200	230	250
Ref.		5003948	5003950	5004278	5003951	5003951	5003952	5003953	5003954	5003956	5003957
€ U.		1,50	1,65	1,90	1,95	1,95	2,60	3,75	4,15	5,35	5,60

### Junta cerámica autoadhesiva | Self-adhesive ceramic gasket | Joint autoadhésif en céramique 600° C



Ref.		Medidas   Measurements   Mesures				
Ref.	2053351					
€ m.	3,50					
	Ø m	80	100	110	125	130
	m (desarrollo   unfolding   déroulage)	0,25	0,31	0,35	0,39	0,41

Ref.	4020318	Unidades de embalaje Packing units Unités d'emballage
€ U.	95,40 1	



**Abrazadera de unión incluida en todas las piezas.**  
Connection bracket included in all parts.  
*Collier de fixation inclus dans toutes les pièces.*



**Junta incluida.**  
Gasket included.  
*Joint inclus.*      \*\* **ø80 - 100**

300	350	400	450	500	550	600	650	700
4020322	4020323	4020324	4029570	4029693	4029844	4030032	4030118	4040229
136,45 1	146,85 1	176,50 1	250,65 1	286,20 1	357,50 1	461,75 1	606,65 1	720,65 1
4023701	4023702	4023703	4029633	4029737	4029904	4030055	4030200	4040230
191,50 1	203,75 1	247,00 1	300,65 1	337,75 1	415,75 1	527,55 1	681,15 1	794,65 1

333	383	433	567	617	667	717	767	817
413	463	513	613	663	713	763	813	863

300	350	400	450	500	550	600	650	700
4026059	4026060	4026061	4026062	4026063	4026064	4026066	4026067	4026069
145,75 1	168,85 1	189,40 1	242,05 1	287,20 1	333,70 1	372,55 1	415,95 1	465,60 1

333	383	435	485	535	585	635	685	735
413	463	515	565	615	665	715	765	815

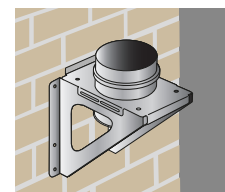
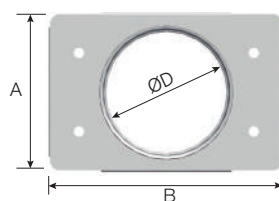
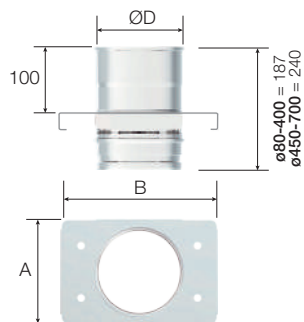

**Escuadra con soporte mural intermedio**  
Square with intermediate wall support  
*Èquerre avec support mural intermédiaire*

**Rosetón blanco | White Rosette | Rosace blanche EPDM**



	80	100	125
Ref.	5005897	5005899	2700131
€ U.	5,95 1	7,45 1	10,25 1

300	350	400	450	500	550	600	650	700
5003973	5003974	5003975	5004828	5004829	5004830	5004831	5004832	5004833
6,00 5	6,70 5	7,40 5	17,25 1	19,55 1	22,00 1	24,45 1	26,75 1	29,35 1



300	350	400	450	500	550	600	650	700
5003958	5003959	5003960	5005716	5005717	5005718	5005719	5005720	5005721
7,60 5	10,30 5	12,90 5	16,15 1	19,35 1	22,40 1	25,85 1	28,95 1	32,35 1

**Lubricante silicona | Silicone lubricant | Graisse silicone**



**150ml**

Ref.	5002932
€ U.	8,60 1

150	180	200	230	250	300	350	400
0,47	0,57	0,63	0,72	0,79	0,94	1,10	1,26

2

### Soporte pared regulable | Adjustable wall support | Support mural réglable



		ØD mm									
		80	100	110	125	130	150	180	200	230	250
AISI 304	Ref.	4600718	4600719	-	4600720	4600725	4600721	4600722	4600723	4600726	4600724
	€ U.	85,15	89,20	-	93,20	98,35	102,70	108,05	118,90	137,75	148,60
Medidas   Measurements   Mesures											
A		133	153	-	178	183	203	232	252	282	302
B		190	210	-	234	240	260	290	310	340	360

### Soporte a techo regulable | Adjustable ceiling mounting | Support au toit réglable



		ØD mm									
		80	100	110	125	130	150	180	200	230	250
AISI 304	Ref.	-	-	-	-	4013467	4014952	4013529	4012519	4013295	4012428
	€ U.	-	-	-	-	85,40	88,15	92,30	92,95	94,30	95,10
GALVA	Ref.	-	-	-	-	4012520	4012521	-	4012523	4012524	4012525
	€ U.	-	-	-	-	58,70	58,70	-	58,70	58,70	58,70

### Abrazadera forjado | Ceiling bracket | Collier support plancher



		ØD mm									
		80	100	110	125	130	150	180	200	230	250
AISI 304	Ref.	4022020	4022021	4022022	4028373	4022023	4022025	4022027	4011861	5001470	5001471
	€ U.	33,70	41,00	41,50	42,00	42,95	44,15	45,80	50,85	53,75	55,35

### Abrazadera forjado reforzada | Reinforced ceiling bracket | Collier support plancher renforcé



		ØD mm									
		80	100	110	125	130	150	180	200	230	250
AISI 304	Ref.	-	-	-	4028374	4026828	9023220	4026934	9023221	4026829	4023222
	€ U.	-	-	-	50,95	50,95	51,30	51,80	52,15	54,10	55,85
Medidas   Measurements   Mesures											
A		-	-	-	103	103	103	103	103	103	103
B		-	-	-	250	250	250	250	250	250	250

### Abrazadera forjado universal | Universal ceiling bracket | Collier support plancher universel \*



		ØD mm									
		80	100	110	125	130	150	180	200	230	250
AISI 304	Ref.	-	-	-	4028318	4026043	4026044	4026045	4026046	4026047	4026048
	€ U.	-	-	-	42,10	42,10	42,30	42,45	43,40	46,95	47,80



Ref.	4600721	Unidades de embalaje Packing units Unités d'emballage
€ U.	102,70 1	

300	350	400
4600727	4600728	4600729
168,75 1	193,05 1	222,75 1

351	401	452
408	458	508

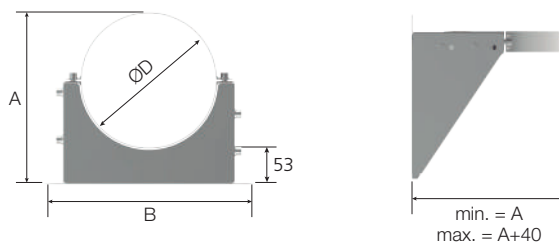

2

300	350	400	450	500	550	600	650	700
4015588	4015660	4014552	4040054	4040055	4040056	4040057	4040058	4040059
97,65 1	98,20 1	116,85 1	134,15 1	138,40 1	142,65 1	146,85 1	162,75 1	168,75 1
-	-	-	-	-	-	-	-	-
-	-	-	-	-	-	-	-	-

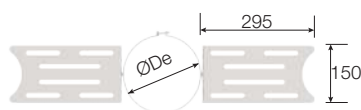

300	350	400	450	500	550	600	650	700
5001456	5001472	5001473	5001475	5001476	5001477	5001478	5001479	5001480
79,65 1	81,15 1	98,15 1	104,60 1	108,60 1	111,70 1	116,40 1	121,90 1	125,65 1

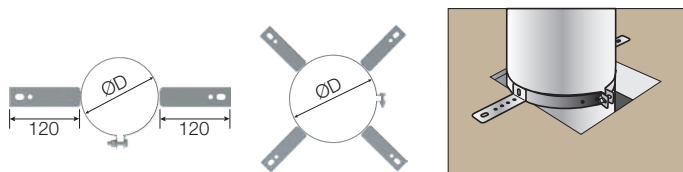

300	350	400	450	500	550	600	650	700
4023223	4023224	4023225	4023226	4026831	4026832	4026833	4026834	4026835
58,45 1	59,95 1	62,10 1	66,60 1	68,60 1	73,05 1	81,35 1	85,85 1	91,15 1

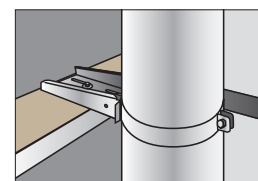
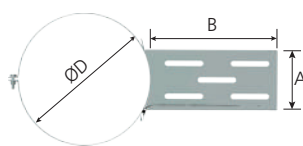

138	138	138	138	173	173	173	173	173
300	300	300	300	350	350	350	350	350

300	350	400	450	500	550	600	650	700
4026080	4026081	4026082	4040131	4040132	4040133	4040134	4040215	4040216
50,90 1	62,75 1	72,25 1	82,30 1	86,30 1	91,10 1	95,85 1	99,35 1	106,50 1

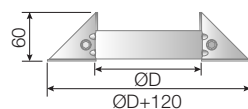

\* Consultar las diferentes opciones de soporte en las páginas 133 y 143.  
For support options, see pages 133 and 143.  
Pour les options de support, voir pages 133 et 143.

# 3 CC

Conducto Concéntrico  
Concentric Piping  
*Conduit Concentrique*

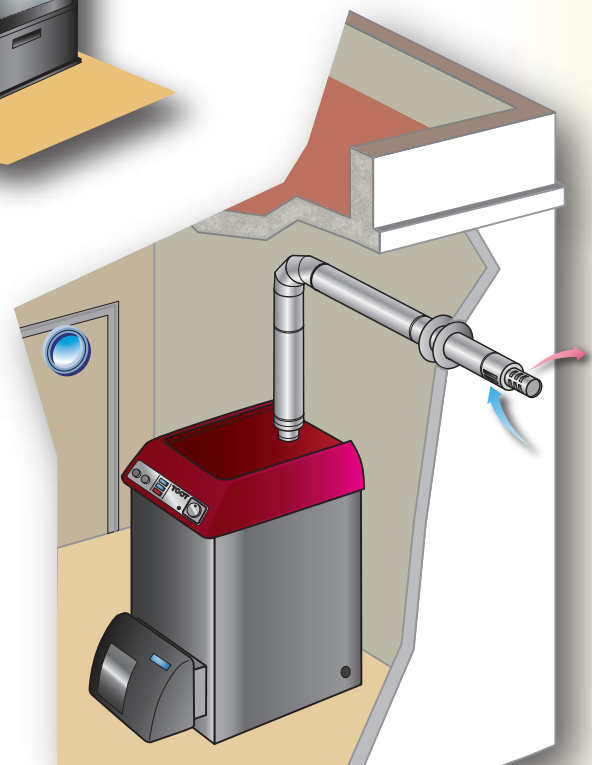
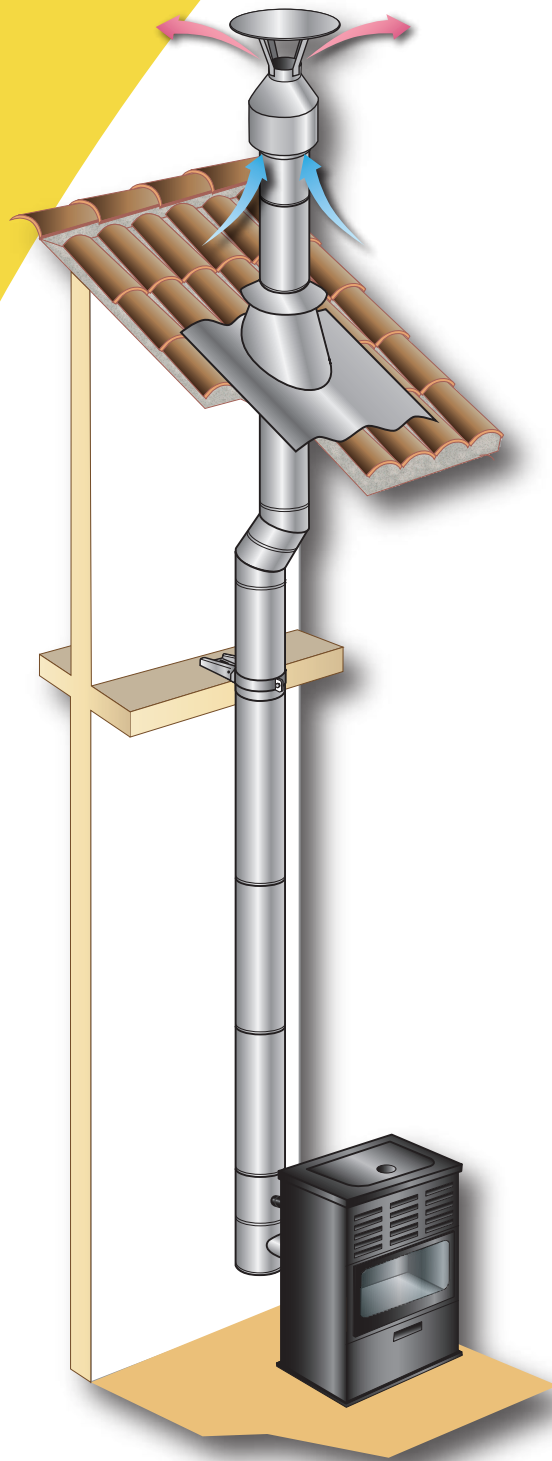



Núm. 14.2/15-2103\_V1



Núm. 14.2/22-2307\_V1

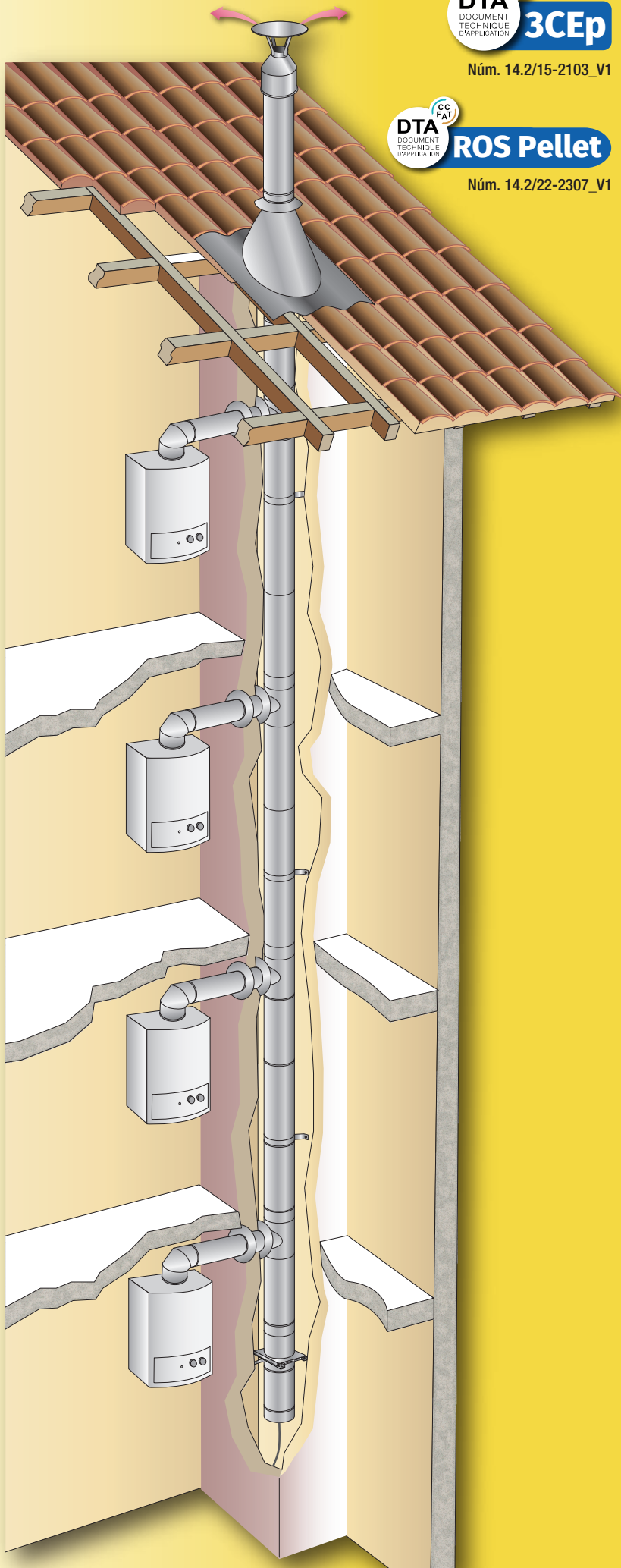

CE Especificaciones de acuerdo a la legislación europea en productos de construcción CPR  
 Specifications according to EU product regulations of construction CPR  
 Spécifications Selon la réglementation européenne concernant les produits de construction CPR

Espesor Thickness Epaisseur	ø80-250	0,4 mm
	ø300-400	0,5 mm



interior | inside | intérieur

AISI 316L

(1.4404) 2R

exterior | outside | extérieur

AISI 304

(1.4301) 2R

### EN 1856-1

T200 P1 W V2 L50040 O(20)\*

T200 N1 W V2 L50040 O(20)

### EN 14989-2

T200 P1 W V2 L50040 O(20)\*

T200 N1 W V2 L50040 O(20)

T450 N1 W V2 L50040 G(100)



interior y exterior | inside and outside | intérieur et extérieur

AISI 304

(1.4301) 2R

### EN 14989-2

T200 P1 W Vm L20040 O(20)\*

T200 N1 W Vm L20040 O(20)

T450 N1 W Vm L20040 G(100)



interior | inside | intérieur

\* AISI 904L

(1.4539) 2R

exterior | outside | extérieur

AISI 304

(1.4301) 2R

### EN 14989-2

\* Consultar Departamento Comercial

Consult Sales Department

Consulter le Département Commercial

### Módulo lineal | Linear module | Élément droit

ØDi / ØDe mm **80/125** **80/130** **100/150** **110/180** **130/200** **150/250** **180/300** **200/350** **250/400**

#### L 1000 mm

AISI	Ref.	4028278	2700144	2700555	-	4010086	-	-	-	-
<b>304-304</b>	€ U.	<b>92,35</b>	<b>93,90</b>	<b>97,30</b>	-	<b>127,95</b>	-	-	-	-
AISI	Ref.	4025846	4012945	4014581	4031460	4016735	4023114	4023119	4023126	4023131
<b>316L-304</b>	€ U.	<b>108,70</b>	<b>110,40</b>	<b>114,40</b>	<b>140,90</b>	<b>147,75</b>	<b>162,45</b>	<b>222,00</b>	<b>273,25</b>	<b>303,25</b>

#### L 500 mm

AISI	Ref.	4028281	2700143	2700590	-	4010087	-	-	-	-
<b>304-304</b>	€ U.	<b>76,75</b>	<b>77,90</b>	<b>82,20</b>	-	<b>102,70</b>	-	-	-	-
AISI	Ref.	4025845	4012944	4014593	4031459	4016738	4023115	4023120	4023128	4023133
<b>316L-304</b>	€ U.	<b>90,25</b>	<b>91,60</b>	<b>94,45</b>	<b>109,75</b>	<b>113,00</b>	<b>114,35</b>	<b>156,15</b>	<b>192,25</b>	<b>213,35</b>

#### L 250 mm

AISI	Ref.	4028282	2700142	2700612	-	4010089	-	-	-	-
<b>304-304</b>	€ U.	<b>61,40</b>	<b>62,35</b>	<b>67,95</b>	-	<b>94,40</b>	-	-	-	-
AISI	Ref.	4025844	4015102	4016739	4031458	4016740	4023117	4023124	4023130	4023135
<b>316L-304</b>	€ U.	<b>74,70</b>	<b>75,95</b>	<b>76,75</b>	<b>86,95</b>	<b>102,85</b>	<b>104,80</b>	<b>138,45</b>	<b>170,35</b>	<b>189,10</b>

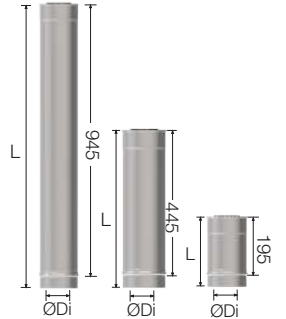

### Módulo extensible | Extendable module | Élément télescopique

ØDi / ØDe mm **80/125** **80/130** **100/150** **110/180** **130/200** **150/250** **180/300** **200/350** **250/400**

#### Lmin 750 mm - Lmax 1350 mm

AISI	Ref.	-	-	4028366	4031436	4028367	4028368	4028369	4028370	4028371
<b>316L-304</b>	€ U.	-	-	<b>203,75</b>	<b>219,90</b>	<b>233,40</b>	<b>284,40</b>	<b>345,25</b>	<b>415,55</b>	<b>440,40</b>

#### Lmin 500 mm - Lmax 900 mm

AISI	Ref.	4028286	4023100	4023102	-	4023103	-	-	-	-
<b>304-304</b>	€ U.	<b>143,20</b>	<b>145,50</b>	<b>153,95</b>	-	<b>185,60</b>	-	-	-	-

AISI	Ref.	4025850	9023075	9023076	9031421	9023077	9023111	4023113	4023118	4023121
<b>316L-304</b>	€ U.	<b>154,85</b>	<b>157,20</b>	<b>168,25</b>	<b>183,35</b>	<b>206,20</b>	<b>248,90</b>	<b>309,65</b>	<b>368,20</b>	<b>394,30</b>

#### Lmin 335 mm - Lmax 565 mm

AISI	Ref.	4028283	2700517	2700581	-	4010090	-	-	-	-
<b>304-304</b>	€ U.	<b>130,45</b>	<b>132,50</b>	<b>133,35</b>	-	<b>149,15</b>	-	-	-	-

AISI	Ref.	4025849	4012946	4014592	9031420	4016741	4023134	9023138	4023139	4023140
<b>316L-304</b>	€ U.	<b>141,00</b>	<b>143,15</b>	<b>145,70</b>	<b>158,05</b>	<b>165,65</b>	<b>216,70</b>	<b>276,65</b>	<b>328,70</b>	<b>348,15</b>

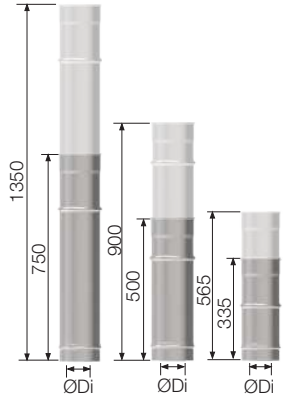

### Codo | Elbow | Coude **30°**

ØDi / ØDe mm **80/125** **80/130** **100/150** **110/180** **130/200** **150/250** **180/300** **200/350** **250/400**

AISI	Ref.	4028289	4023122	4023123	-	4023125	-	-	-	-
<b>304-304</b>	€ U.	<b>72,05</b>	<b>73,10</b>	<b>78,20</b>	-	<b>92,40</b>	-	-	-	-
AISI	Ref.	4028305	4023088	4023089	4031416	4023090	4023147	4023148	4023150	4023151
<b>316L-304</b>	€ U.	<b>75,80</b>	<b>76,95</b>	<b>82,30</b>	<b>94,15</b>	<b>97,30</b>	<b>126,55</b>	<b>157,40</b>	<b>193,90</b>	<b>215,10</b>

Medidas | Measurements | Mesures

	H	46	46	48	50	51	54	58	61	64
V		129	130	135	142	147	160	172	185	197

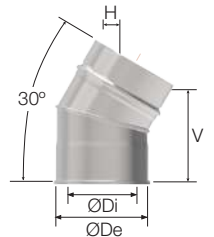

### Codo | Elbow | Coude **45°**

ØDi / ØDe mm **80/125** **80/130** **100/150** **110/180** **130/200** **150/250** **180/300** **200/350** **250/400**

AISI	Ref.	4028290	2700139	2700556	-	4010092	-	-	-	-
<b>304-304</b>	€ U.	<b>72,05</b>	<b>73,10</b>	<b>78,20</b>	-	<b>92,40</b>	-	-	-	-
AISI	Ref.	4027144	4012947	4014583	4031417	4016744	4023153	4023154	4023156	4023158
<b>316L-304</b>	€ U.	<b>75,80</b>	<b>76,95</b>	<b>82,30</b>	<b>94,15</b>	<b>97,30</b>	<b>126,55</b>	<b>157,40</b>	<b>193,90</b>	<b>215,10</b>

Medidas | Measurements | Mesures

	H	72	73	75	80	82	90	97	104	112
V		131	132	139	149	156	174	191	204	227

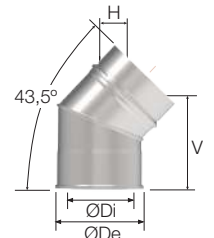

### Codo | Elbow | Coude **87°**

ØDi / ØDe mm **80/125** **80/130** **100/150** **130/200** **150/250**

AISI	Ref.	4028291	2700140	2700580	-	4010093	-
<b>304-304</b>	€ U.	<b>115,30</b>	<b>117,10</b>	<b>125,00</b>	-	<b>151,80</b>	-
AISI	Ref.	4025847	4012948	4014584	-	4016745	4040026
<b>316L-304</b>	€ U.	<b>121,40</b>	<b>123,25</b>	<b>131,55</b>	-	<b>159,70</b>	<b>199,60</b>

Medidas | Measurements | Mesures

	V	112	114	124	-	146	170
H		162	163	173	-	194	215



Ref.	2700555	Unidades de embalaje Packing units Unités d'emballage
€ U.	97,30 1	



**Abrazadera de unión incluida en todas las piezas.**  
Connection bracket included in all parts.  
*Collier de fixation inclus dans tous les pièces.*



**Junta incluida.**  
Gasket included.  
*Joint inclus.*

### Te sin tapa | "T" Piece without cap | Té sans tampon **93°**



ØDi / ØDe mm		80/125	80/130	100/150	130/200	150/250
AISI <b>304-304</b>	Ref.	4028294	4023083	4023084	4023087	-
	€ U.	102,80 1	116,30 1	119,80 1	143,10 1	-
AISI <b>316L-304</b>	Ref.	4028307	4028446	4028447	4028448	4040035
	€ U.	108,20 1	122,40 1	126,10 1	150,65 1	188,20 1

Medidas | Measurements | Mesures

	L	245	245	278	315	364
H	115	118	130	155	180	
V	100	100	115	135	160	

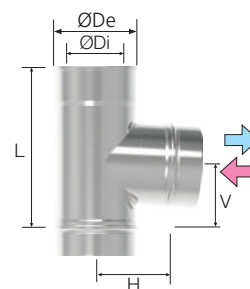

### Te admisión reducida a 60 | Admission "T" Piece reduced to 60 | Té admission réduit à 60 **90°**



ØDi / ØDe mm		80/125	80/130	100/150	130/200
AISI <b>304-304</b>	Ref.	4028295	4015481	4015793	4023091
	€ U.	128,60 1	130,60 1	151,80 1	170,80 1
AISI <b>316L-304</b>	Ref.	4028308	4020568	4020569	4023066
	€ U.	135,40 1	137,45 1	159,70 1	179,85 1

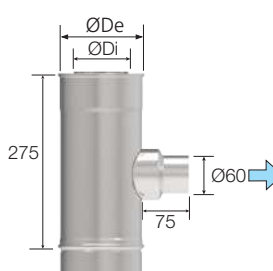

### Te salida gas con tapa purga | "T" Piece gas outlet with condensate cap | Té sortie gaz avec tampon récupérateur condensats **93°**



ØDi / ØDe mm		80/125	80/130	100/150	130/200
AISI <b>304-304</b>	Ref.	4028296	4023093	4023094	4023095
	€ U.	242,25 1	257,10 1	291,45 1	318,55 1
AISI <b>316L-304</b>	Ref.	4028309	4023067	9023068	4023069
	€ U.	255,70 1	265,10 1	300,85 1	334,05 1

Medidas | Measurements | Mesures

	L	318	318	351	368
H	156	156	166	182	
V	137	137	153	161	
øDd	80	80	100	130	

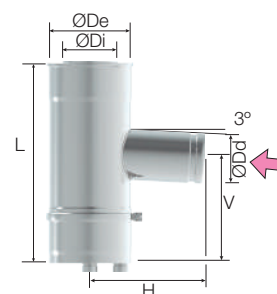

### Adaptador caldera | Boiler adapter | Adaptateur chaudière



ØDi / ØDe mm		80/125	80/130	100/150	130/200
AISI <b>304-304</b>	Ref.	4028293	4023107	2700613	4015213
	€ U.	49,20 1	50,00 1	52,45 1	65,85 1
AISI <b>316L-304</b>	Ref.	4028306	9023112	4014586	4016743
	€ U.	54,60 1	55,45 1	58,35 1	73,10 1

Medidas | Measurements | Mesures

	ØDni	82	82	102	132
	ØDne	127	132	152	202

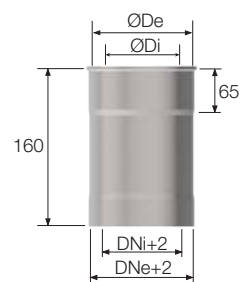

### Adaptador caldera interior | Interior boiler adapter | Adaptateur chaudière intérieure



ØDi / ØDe mm		80/125	80/130	100/150	130/200
AISI <b>316L-304</b>	Ref.	4028320	4028321	4028322	4028323
	€ U.	65,55 1	66,60 1	69,95 1	87,75 1



### Adaptador caldera interior con analizador de gas | Interior boiler adapter with gas inspection | Adaptateur chaudière intérieure avec inspection de gaz



ØDi / ØDe mm		80/125	80/130	100/150	110/180	130/200
AISI <b>316L-304</b>	Ref.	4028330	4028331	4028332	4028333	4028334
	€ U.	105,25 1	105,45 1	108,30 1	109,65 1	114,40 1

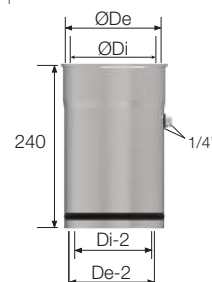

3

Módulo analizador de gas | Gas inspection module | Module d'inspection de gaz



		ØDi / ØDe mm				
		80/125	80/130	100/150	110/180	130/200
AISI 304-304	Ref.	-	2700141	2700618	-	4015212
	€ U.	-	78,90 1	81,25 1	-	126,25 1
AISI 316L-304	Ref.	4015100	4015103	4014582	4031440	4016742
	€ U.	105,25 1	105,45 1	108,35 1	109,65 1	164,10 1



Adaptador conector aumento | Augmentation connection adapter | Adaptateur raccord augmentation



		ØDi / ØDe mm			
		60/100	80/110	80/125	
AISI 304-304	Ref.	80/130	4023110	-	4023116
	€ U.	80/130	108,70 1	-	97,50 1
Medidas   Measurements   Mesures		L	180		
AISI 316L-304	Ref.	80/125	4023108	4023343	-
	€ U.	80/125	114,35 1	109,35 1	-
	Ref.	80/130	4023109	4023344	4012949
	€ U.	80/130	114,35 1	109,35 1	102,60 1
Medidas   Measurements   Mesures		L	160		



Piezas específicas para instalaciones colectivas | Specific pieces for collective installations

Pièces spécifiques pour installations collectives



Te reducida a | "T" Piece reduced to | Té réduit à 60/100 93°



		ØDi / ØDe mm						
		100/150	110/180	130/200	150/250	180/300	200/350	250/400
AISI 316L-304	Ref.	4020464	4031447	4020416	4028382	4021580	4028383	4028384
	€ U.	170,65 1	183,80 1	201,10 1	220,75 1	260,30 1	313,55 1	332,35 1



Te reducida a | "T" Piece reduced to | Té réduit à 80/130 93°



		ØDi / ØDe mm						
		100/150	110/180	130/200	150/250	180/300	200/350	250/400
AISI 316L-304	Ref.	4022397	4031449	4023175	4023179	4023180	4023191	4023192
	€ U.	186,35 1	201,15 1	220,30 1	242,55 1	285,35 1	343,00 1	365,15 1

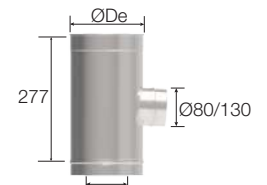

Te reducida a | "T" Piece reduced to | Té réduit à 80/130 93°



		ØDi / ØDe mm							
		80/130	100/150	110/180	130/200	150/250	180/300	200/350	250/400
AISI 316L-304	Ref.	4032974	4023205	4031457	4023206	4023207	4023208	4023209	4023211
	€ U.	211,85 1	223,00 1	238,60 1	262,85 1	298,35 1	370,90 1	406,40 1	433,20 1

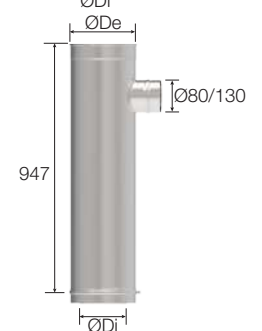

Conducto de conexión | Connection piping | Conduit de raccordement

RAL 9016



		ØDi / ØDe mm
		80/130
AISI 316L-304	Ref.	4026068
	€ U.	102,70 1

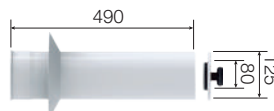

Reducción | Reduction adapter | Réduction



		ØDi / ØDe mm
		80/130 - 80/125
AISI 316L-304	Ref.	4019106
	€ U.	102,35 1

Ref.	4028382	Unidades de embalaje Packing units Unités d'emballage
€ U.	220,75 <sup>1</sup>	



Abrazadera de unión incluida en todas las piezas.  
Connection bracket included in all parts.  
Collier de fixation inclus dans tous les pièces.



Junta incluida.  
Gasket included.  
Joint inclus.

### Módulo inspección | Inspection module | Module d'inspection \*



ØDi / ØDe mm		80/125	80/130	100/150	130/200
AISI <b>304-304</b>	Ref.	4028298	4023096	4023097	4023098
	€ U.	104,95 <sup>1</sup>	106,60 <sup>1</sup>	112,00 <sup>1</sup>	118,95 <sup>1</sup>
AISI <b>316L-304</b>	Ref.	4028311	4023072	4023073	4023074
	€ U.	108,20 <sup>1</sup>	109,85 <sup>1</sup>	115,55 <sup>1</sup>	122,60 <sup>1</sup>
Medidas   Measurements   Mesures					
L		245	245	278	315

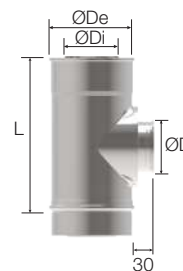

\* No incluye tapa  
Cover not included  
Couvercle non inclus

### Te giratoria | Rotary "T" Piece | Té rotatif

		ØDi / ØDe mm		80/130		100/150	
		standard	reducida a reduced to réduit à	standard	reducida a reduced to réduit à		
		ø80	ø60	ø80	ø60		
AISI <b>316L-304</b>	Te giratoria 90° H/H Rotary "T" piece 90° F/F Té rotatif 90° F/F	Ref.	<sup>1</sup> 4029295	-	<sup>1</sup> 4029296	-	
	€ U.	357,40 <sup>1</sup>	-	287,20 <sup>1</sup>	-		
	Te giratoria 90° M/H Rotary "T" piece 90° M/F Té rotatif 90° M/F	Ref.	<sup>2</sup> 4022090	<sup>3</sup> 4023071	<sup>2</sup> 4029293	<sup>3</sup> 9023070	
	€ U.	346,90 <sup>1</sup>	411,05 <sup>1</sup>	364,35 <sup>1</sup>	431,80 <sup>1</sup>		
Medidas   Measurements   Mesures							
C		105		135			
L		320		360			

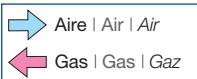

<sup>1</sup> Te giratoria 90° H/H standard  
Rotary "T" piece 90° F/F standard  
Té rotatif 90° F/F standard

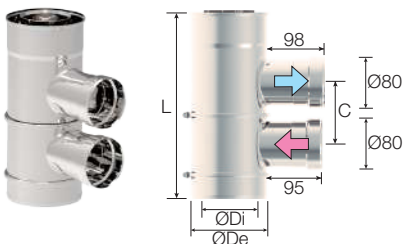

<sup>2</sup> Te giratoria 90° M/H standard  
Rotary "T" piece 90° M/F standard  
Té rotatif 90° M/F standard

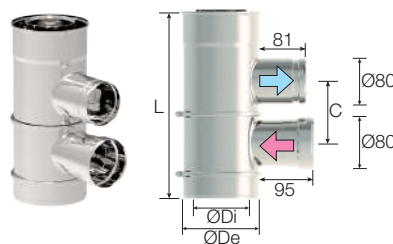

<sup>3</sup> Te giratoria 90° M/H reducida  
Rotary "T" piece 90° M/F reduced  
Té rotatif 90° M/F réduit

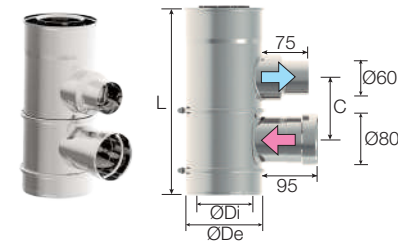

### Tapa | Cap | Tampon



ØDi / ØDe mm		80/125	80/130	100/150	130/200
AISI <b>316L-304</b>	Ref.	4028312	4020663	4020664	4023082
	€ U.	80,15 <sup>1</sup>	81,40 <sup>1</sup>	84,00 <sup>1</sup>	87,10 <sup>1</sup>

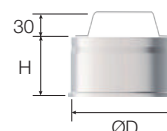

### Tapa purga | Condensate cap | Tampon récupérateur condensats



ØDi / ØDe mm		80/125	80/130	100/150	110/180	130/200	150/250	180/300	200/350	250/400
AISI <b>316L-304</b>	Ref.	4028313	4020602	4020465	4031445	4020604	4023248	4023249	4023251	4023252
	€ U.	98,40 <sup>1</sup>	99,95 <sup>1</sup>	105,40 <sup>1</sup>	107,10 <sup>1</sup>	109,60 <sup>1</sup>	119,95 <sup>1</sup>	130,75 <sup>1</sup>	141,70 <sup>1</sup>	164,30 <sup>1</sup>
Medidas   Measurements   Mesures										
ØG		1/2"	1/2"	1/2"	1/2"	1/2"	1/2"	3/4"	3/4"	3/4"

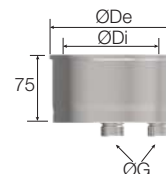

### Tapa de inspección | Inspection cover | Trappe d'inspection 200°C / 200 Pa



ØDi / ØDe mm		80/125	80/130	100/150	130/200
AISI <b>304</b>	Ref.	5003265	5003265	5003266	5003267
	€ U.	25,75 <sup>1</sup>	25,75 <sup>1</sup>	26,20 <sup>1</sup>	30,70 <sup>1</sup>



### Tapa de inspección | Inspection cover | Trappe d'inspection 450°C / 40 Pa



ØDi / ØDe mm		80/125	80/130	100/150	130/200
AISI <b>304</b>	Ref.	5003391	5003391	5003392	5003393
	€ U.	36,05 <sup>1</sup>	36,05 <sup>1</sup>	41,60 <sup>1</sup>	47,10 <sup>1</sup>

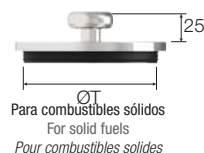

3

### Adaptador biflujo horizontal | Horizontal biflow adapter | Adaptateur de bi-flux horizontal



ØDi / ØDe mm		80/125	80/130	100/150	130/200	150/250
AISI	Ref.	4040020	4040021	4040022	4040023	4040025
<b>316L-304</b>	€ U.	<b>182,65</b> 1	<b>185,50</b> 1	<b>214,15</b> 1	<b>246,80</b> 1	<b>296,20</b> 1
Medidas   Measurements   Mesures						
ØDs		60	60	60	80	80
Aire   Air   Air Gas   Gas   Gaz						

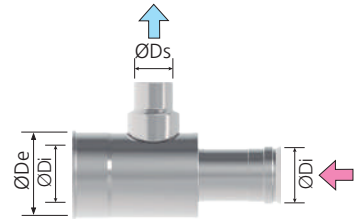

### Kit base inicial trípode | Floor base tripod kit | Kit trépied plaque de départ au sol



#### 1 Tapa condensación trípode | Tripod condensate cap | Tampon condensats trépied

ØDi / ØDe mm		80/125	80/130	100/150	110/180	130/200
AISI	Ref.	4033305	4033306	4033307	4033308	4033309
<b>316L-304</b>	€ U.	<b>98,30</b> 1	<b>99,80</b> 1	<b>105,25</b> 1	<b>107,10</b> 1	<b>109,40</b> 1

#### 2 Soporte base trípode | Base tripod support | Support au sol trépied

ØDi / ØDe mm		80/125	80/130	100/150	110/180	130/200
AISI	Ref.	4033310	4033310	4033453	4033454	4033455
<b>304</b>	€ U.	<b>71,45</b> 1	<b>71,45</b> 1	<b>73,80</b> 1	<b>75,05</b> 1	<b>76,70</b> 1

Prolongación base trípode 1 m  
Base tripod extension 1 m  
Rallonge support au sol trépied 1 m

Ref.	4033311
€ U.	<b>46,70</b> 1

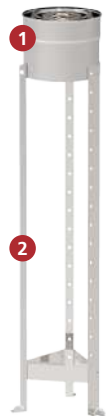

### Sombrero salida vertical | Vertical exit cap | Chapeau sortie verticale



ØDi / ØDe mm		80/125	80/130	100/150	110/180	130/200	150/250	180/300	200/350	250/400
AISI	Ref.	4028303	2700518	2700557	-	4010094	-	-	-	-
<b>304-304</b>	€ U.	<b>184,80</b> 1	<b>187,20</b> 1	<b>196,65</b> 1	-	<b>199,90</b> 1	-	-	-	-
AISI	Ref.	4028314	4012950	4014585	4031442	4016746	4028377	4028378	4028379	4028380
<b>316L-304</b>	€ U.	<b>205,30</b> 1	<b>208,10</b> 1	<b>218,55</b> 1	<b>220,30</b> 1	<b>222,10</b> 1	<b>248,90</b> 1	<b>276,65</b> 1	<b>304,45</b> 1	<b>349,45</b> 1
Medidas   Measurements   Mesures										
ØDp		250	250	250	250	300	300	350	400	500
ØDd		178	178	198	180	298	300	400	500	550

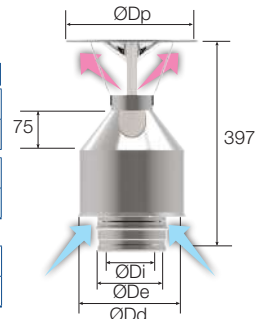

### Sombrero salida horizontal | Horizontal exit cap | Chapeau sortie horizontale



ØDi / ØDe mm		80/125	80/130	100/150	130/200	150/250
AISI	Ref.	4028302	2700145	2700582	4010095	-
<b>304-304</b>	€ U.	<b>181,30</b> 1	<b>183,15</b> 1	<b>188,40</b> 1	<b>209,70</b> 1	-
AISI	Ref.	4028315	4013748	4016747	4016748	4016749
<b>316L-304</b>	€ U.	<b>190,85</b> 1	<b>192,85</b> 1	<b>198,40</b> 1	<b>220,75</b> 1	<b>276,00</b> 1

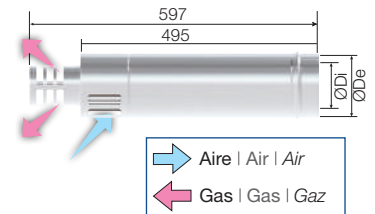

### Abrazadera de unión tornillo | Connection bracket, screwed | Collier de fixation à vis



ØDi - ØDe mm		80/125	80/130	100/150	110/180	130/200	150/250	180/300	200/350	250/400
AISI	Ref.	5004280	5003967	5003968	5003969	5003970	5003972	5003973	5003974	5003975
<b>304</b>	€ U.	<b>4,70</b> 10	<b>4,75</b> 10	<b>4,90</b> 10	<b>5,05</b> 10	<b>5,15</b> 10	<b>5,60</b> 10	<b>6,00</b> 5	<b>6,70</b> 5	<b>7,40</b> 5



### Junta silicona | Silicone gasket | Joint silicone



ØDi / ØDe mm		80/125	80/130	100/150	110/180	130/200	150/250	180/300	200/350	250/400
Ref.		5003948	5003948	5003950	5004278	5003951	5003952	5003953	5003954	5003957
€ U.		<b>1,50</b> 10	<b>1,50</b> 10	<b>1,65</b> 10	<b>1,90</b> 10	<b>1,95</b> 10	<b>2,60</b> 10	<b>3,75</b> 10	<b>4,15</b> 10	<b>5,60</b> 10



Ref.	4033307	Unidades de embalaje Packing units Unités d'emballage
€ U.	105,25 <sup>1</sup>	



Abrazadera de unión incluida en todas las piezas.  
Connection bracket included in all parts.  
Collier de fixation inclus dans tous les pièces.



Junta incluida.  
Gasket included.  
Joint inclus.

### Abrazadera mural exterior | External wall bracket | Collier support mural extérieur \*



		ØDi - ØDe mm			
		80/125	80/130	100/150	130/200
AISI 304	Ref.	4035905	4019876	4019877	4019879
	€ U.	59,10 <sup>1</sup>	53,50 <sup>1</sup>	54,10 <sup>1</sup>	60,90 <sup>1</sup>

\* Opción regulable: añadir Prolongación mural (ver pág. 132)  
Adjustable option: add Wall extension (see page 132)  
Option réglable: ajouter Rallonge murale (voir page 132)

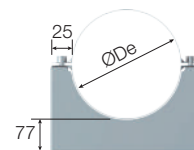

### Abrazadera mural interior | Interior wall bracket | Collier support mural intérieur \*



		ØDi - ØDe mm								
		80/125	80/130	100/150	110/180	130/200	150/250	180/300	200/350	250/400
AISI 304	Ref.	4013902	2500038	2500039	2500040	2500041	2500042	2500043	2500510	2500044
	€ U.	13,50 <sup>6</sup>	13,90 <sup>6</sup>	14,75 <sup>6</sup>	15,90 <sup>6</sup>	17,75 <sup>6</sup>	25,60 <sup>2</sup>	32,85 <sup>2</sup>	44,95 <sup>2</sup>	63,60 <sup>2</sup>

Medidas | Measurements | Mesures

A	150	150	150	160	190	230	230	300	300
---	-----	-----	-----	-----	-----	-----	-----	-----	-----

\* Opción regulable: añadir Prolongación mural (ver pág. 132)  
Adjustable option: add Wall extension (see page 132)  
Option réglable: ajouter Rallonge murale (voir page 132)

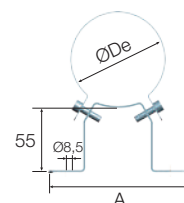

### Abrazadera pared regulable | Adjustable wall bracket | Collier mural réglable



		ØDi - ØDe mm								
		80/125	80/130	100/150	110/180	130/200	150/250	180/300	200/350	250/400
AISI 304	Ref.	4600702	4600707	4600703	4600705	4600704	4600706	4600709	4600710	4600711
	€ U.	16,45 <sup>1</sup>	17,05 <sup>1</sup>	19,30 <sup>1</sup>	23,65 <sup>1</sup>	29,00 <sup>1</sup>	38,10 <sup>1</sup>	46,00 <sup>1</sup>	46,20 <sup>1</sup>	59,25 <sup>1</sup>

Medidas | Measurements | Mesures

A	186	186	186	196	226	266	266	336	336
---	-----	-----	-----	-----	-----	-----	-----	-----	-----

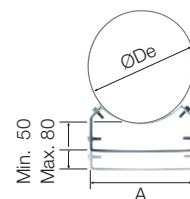

### Abrazadera de vientos | Roof brace band | Collier pour hauban



		ØDi - ØDe mm								
		80/125	80/130	100/150	110/180	130/200	150/250	180/300	200/350	250/400
AISI 304	Ref.	4013907	2700121	2700190	2700241	2700295	2700354	2700403	2700323	2700418
	€ U.	30,15 <sup>3</sup>	30,35 <sup>3</sup>	31,60 <sup>3</sup>	37,70 <sup>3</sup>	39,80 <sup>3</sup>	49,15 <sup>1</sup>	67,75 <sup>1</sup>	75,25 <sup>1</sup>	85,70 <sup>1</sup>



### Rosetón blanco | White Rosette | Rosace blanche EPDM



		125
Ref.		2700131
€ U.		10,25 <sup>1</sup>

### Sifón | Siphon | Siphon



Ref.	4030741
€ U.	41,00 <sup>1</sup>

max. 160° C

### Soporte mural intermedio | Intermediate wall support | Support mural intermédiaire \*



ØDi / ØDe mm		80/125	80/130	100/150	110/180	130/200	150/250	180/300	200/350	250/400
AISI	Ref.	4028316	4023078	4023079	4031444	4023080	4023213	4023214	4023269	4023274
<b>316L-304</b>	€ U.	<b>88,30</b>	<b>88,30</b>	<b>92,35</b>	<b>95,20</b>	<b>124,95</b>	<b>134,90</b>	<b>144,25</b>	<b>180,45</b>	<b>192,40</b>
Medidas   Measurements   Mesures										
	A	160	165	185	213	233	283	333	383	433
	B	240	245	265	293	313	363	413	463	513

\* No incluye escuadras | Square supports not included | Équerres de support non inclus

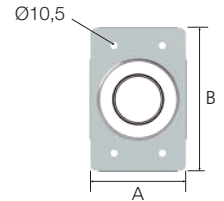
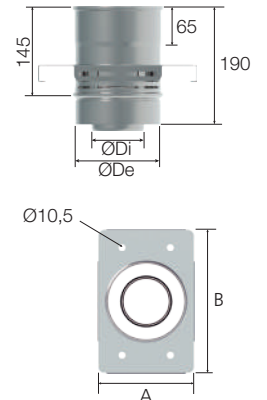

### Soporte mural universal | Universal wall support | Support mural universel \*

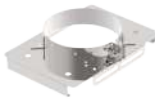

ØDi / ØDe mm		80/125	80/130	100/150	110/180	130/200	150/250	180/300	200/350	250/400
AISI	Ref.	4028317	4026049	4026050	4026051	4026052	4026054	4026059	4026060	4026061
<b>304</b>	€ U.	<b>80,35</b>	<b>81,40</b>	<b>86,10</b>	<b>93,70</b>	<b>101,75</b>	<b>119,20</b>	<b>145,75</b>	<b>168,85</b>	<b>189,40</b>
Medidas   Measurements   Mesures										
	A	165	165	185	213	233	283	333	383	435
	B	245	245	265	293	313	363	413	463	515

\* No incluye escuadras | Square supports not included | Équerres de support non inclus

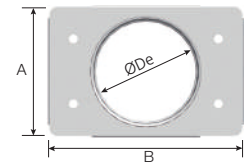

### Escuadra de soporte (2 unidades) | Square support (2 units) | Équerre de support (2 unités)



		Pequeña* Small* Petit*	Mediana* Medium* Moyen*	Grande* Large* Grand*
AISI	Ref.	4019925	4019926	4019927
<b>304</b>	€ Kit	<b>70,65</b>	<b>94,25</b>	<b>122,35</b>
Medidas   Measurements   Mesures				
	L	245	360	515
	H	290	430	610

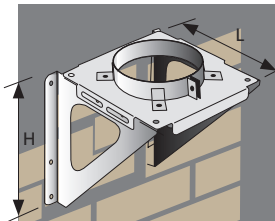

\* Consultar el tamaño adecuado en la página 143.  
Refer to the appropriate size on page 143.  
Voir la taille appropriée à la page 143.

Escuadra con soporte mural  
Square with wall support  
Équerre avec support mural

### Escuadra de soporte reforzada (2 unidades) | Reinforced square support (2 units) | Équerre de support renforcé (2 unités)



		L	500 mm	750 mm	1000 mm
AISI	Ref.	5003914	5003915	5003916	
<b>304</b>	€ Kit	<b>194,95</b>	<b>257,35</b>	<b>292,50</b>	
Medidas   Measurements   Mesures					
	H	310	470	600	

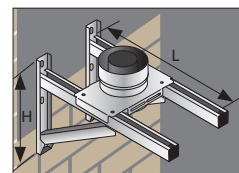

Escuadra reforzada con soporte mural  
Reinforced square with wall support  
Support renforcé avec support mural

Ref.	4023213	Unidades de embalaje Packing units Unités d'emballage
€ U.	134,90 <sup>1</sup>	



**Abrazadera de unión incluida en todas las piezas.**  
Connection bracket included in all parts.  
*Collier de fixation inclus dans tous les pièces.*



**Junta incluida.**  
Gasket included.  
*Joint inclus.*

### Abrazadera forjado | Ceiling bracket | *Collier support plancher*

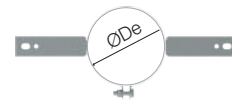

Ø 80/125 - 130/200

ØDi / ØDe mm		80/125	80/130	100/150	110/180	130/200	150/250	180/300	200/350	250/400
AISI 304	Ref.	4028373	4022023	4022025	4022027	4011861	5001471	5001456	5001472	5001473
	€ U.	42,00 <sup>1</sup>	42,95 <sup>1</sup>	44,15 <sup>1</sup>	45,80 <sup>1</sup>	50,85 <sup>1</sup>	55,35 <sup>1</sup>	79,65 <sup>1</sup>	81,15 <sup>1</sup>	98,15 <sup>1</sup>



Ø 150/250 - 250/400

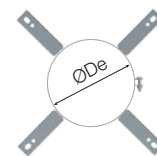

3

### Abrazadera forjado reforzada | Reinforced ceiling bracket | *Collier support plancher renforcé*



ØDi / ØDe mm		80/125	80/130	100/150	110/180	130/200	150/250	180/300	200/350	250/400
AISI 304	Ref.	4028374	4026828	9023220	4026934	9023221	4023222	4023223	4023224	4023225
	€ U.	50,95 <sup>1</sup>	50,95 <sup>1</sup>	51,30 <sup>1</sup>	51,80 <sup>1</sup>	52,15 <sup>1</sup>	55,85 <sup>1</sup>	58,45 <sup>1</sup>	59,95 <sup>1</sup>	62,10 <sup>1</sup>
Medidas   Measurements   Mesures										
	A	103	103	103	103	103	103	138	138	138
	B	250	250	250	250	250	250	300	300	300

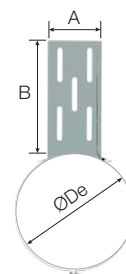

### Abrazadera forjado universal | Universal ceiling bracket | *Collier support plancher universel* \*



ØDi / ØDe mm		80/125	80/130	100/150	110/180	130/200	150/250	180/300	200/350	250/400
AISI 304	Ref.	4028318	4026043	4026044	4026045	4026046	4026048	4026080	4026081	4026082
	€ U.	42,10 <sup>1</sup>	42,10 <sup>1</sup>	42,30 <sup>1</sup>	42,45 <sup>1</sup>	43,40 <sup>1</sup>	47,80 <sup>1</sup>	50,90 <sup>1</sup>	62,75 <sup>1</sup>	72,25 <sup>1</sup>

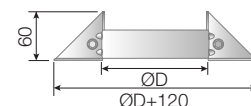

\* Consultar las diferentes opciones de soporte en las páginas 133 y 143.  
For support options, see pages 133 and 143.  
*Pour les options de support, voir pages 133 et 143.*

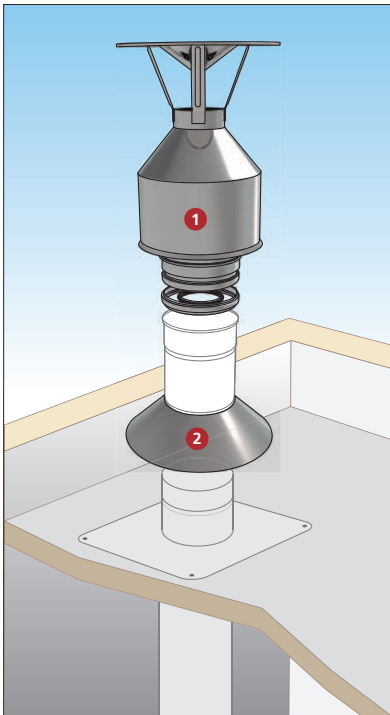

## Kit terminal End-piece kit Kit finition

El kit incluye los siguientes elementos: | The kit includes: | *Le kit comprend les éléments suivants:*

<b>1</b>	<b>Sombrero salida vertical + junta</b> Vertical termination + gasket <i>Chapeau sortie verticale + joint</i>
	Ø 80 - 130
	Ø 100 - 150
	Ø 110 - 180
	Ø 130 - 200
	Ø 150 - 250
<b>+</b>	<b>Juntas   Gaskets   Joints</b>
	Ø 80 - 130
	Ø 100 - 150 / Ø 110 - 180
	Ø 130 - 200
	Ø 150 - 250



<b>2</b>	<b>Collarín   Storm collar   Collettere 75 mm</b>
	Ø 80 - 130
	Ø 100 - 150
	Ø 110 - 180
	Ø 130 - 200
	Ø 150 - 250

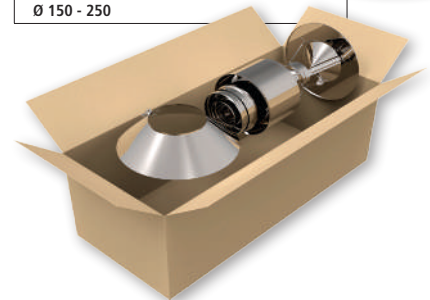
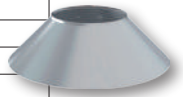

Puede encontrar estos módulos en las secciones concéntricas de esta tarifa.  
You can find these modules in the concentric sections of this price list.  
*Vous pouvez trouver ces modules dans les sections concentriques de ce tarif.*

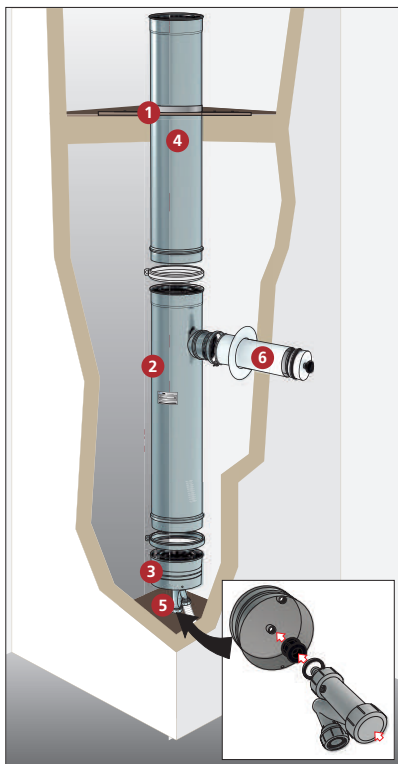

## Kit base Base kit Kit départ au sol

El kit incluye los siguientes elementos: | The kit includes: | *Le kit comprend les éléments suivants:*

<b>1</b>	<b>Abrazadera forjado</b> Ceiling bracket   <i>Collier support plancher</i>
	Ø 80 - 130
	Ø 100 - 150
	Ø 110 - 180
	Ø 130 - 200
	Ø 150 - 250
<b>3</b>	<b>Tapa condensación</b> Condensate cap <i>Tampon récupérateur condensats</i>
	Ø 80 - 130
	Ø 100 - 150
	Ø 110 - 180
	Ø 130 - 200
	Ø 150 - 250
<b>5</b>	<b>Kit sifón   Siphon kit   <i>Kit siphone 1/2"</i></b>
<b>6</b>	<b>Conducto de conexión   Conexión conduit   <i>Conduit de liaison</i></b> Ø 80/125 - 80/130
<b>+</b>	<b>Juntas   Gaskets   Joints</b>
	Ø 80 - 130
	Ø 100 - 150 / Ø 110 - 180
	Ø 130 - 200
	Ø 150 - 250

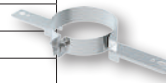

<b>2</b>	<b>Te 93° reducido a Ø80/130+2 juntas</b> "T" Piece 93° reduced to Ø80/130+2 gaskets <i>Té 93° réduit à Ø80/130+2 joints</i>
	Ø 80 - 130
	Ø 100 - 150
	Ø 110 - 180
	Ø 130 - 200
	Ø 150 - 250



<b>4</b>	<b>Módulo lineal   Linear module   <i>Élément droit</i></b> 1000 mm+Juntas   Gaskets   <i>Joints</i>
	Ø 80 - 130
	Ø 100 - 150
	Ø 110 - 180
	Ø 130 - 200
	Ø 150 - 250

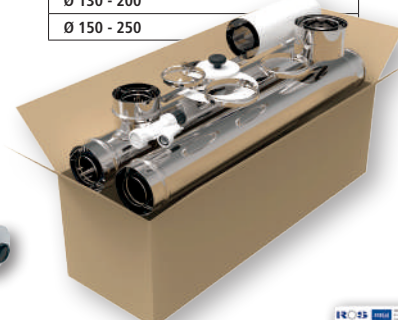

Puede encontrar estos módulos en las secciones concéntricas de esta tarifa.  
You can find these modules in the concentric sections of this price list.  
*Vous pouvez trouver ces modules dans les sections concentriques de ce tarif.*

Adhesivo identificativo  
Identifying adhesive label  
*Étiquette d'identification*  
3CEP - REF. 4033302



## Kit forjado Ceiling kit Kit plancher

ØD	Referencia Reference Référence	Precio Price Prix
80 - 130	4035389	630,40 €
100 - 150	4035390	657,25 €
110 - 180	4035391	723,75 €
130 - 200	4035392	793,45 €
150 - 250	4035398	880,75 €

El kit incluye los siguientes elementos: | The kit includes: | Le kit comprend les éléments suivants:

**1** Abrazadera forjado  
Ceiling bracket | Collier support plancher

Ø 80 - 130
Ø 100 - 150
Ø 110 - 180
Ø 130 - 200
Ø 150 - 250

**3** Conducto de conexión |  
Conexion conduit | Conduit de liaison  
Ø 80/125 - 80/130

**5** Módulo lineal 1000 mm + juntas  
Linear module 1000 mm + gaskets  
Élément droit 1000 mm + joints

Ø 80 - 130
Ø 100 - 150
Ø 110 - 180
Ø 130 - 200
Ø 150 - 250

**+** Juntas | Gaskets | Joints

Ø 80 - 130
Ø 100 - 150 / Ø 110 - 180
Ø 130 - 200
Ø 150 - 250

**2** Te 93° reducido a Ø80/130 + 2 juntas  
"T" Piece 93° reduced to Ø80/130 + 2 gaskets  
Té 93° réduit à Ø80/130 + 2 joints

Ø 80 - 130
Ø 100 - 150
Ø 110 - 180
Ø 130 - 200
Ø 150 - 250

**4** Módulo extensible | Extendable element  
Élément télescopique 750-1350 + 2 joints

Ø 80 - 130
Ø 100 - 150
Ø 110 - 180
Ø 130 - 200
Ø 150 - 250

Adhesivo identificativo  
Identifying adhesive label  
Étiquette d'identification  
3CEP - REF. 4033302



Puede encontrar estos módulos en las secciones concéntricas de esta tarifa.  
You can find these modules in the concentric sections of this price list.  
Vous pouvez trouver ces modules dans les sections concentriques de ce tarif.

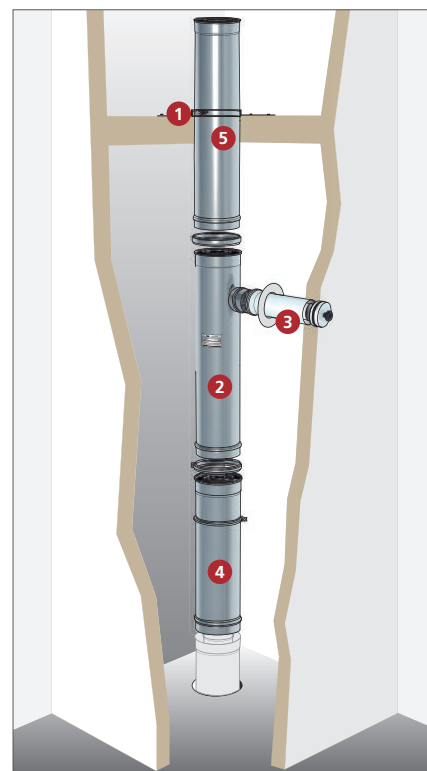

3

## Kit pasante Bushing kit Kit borgne

ØD	Referencia Reference Référence	Precio Price Prix
80 - 130	4032977	443,15 €
100 - 150	4032978	493,70 €
110 - 180	4032979	554,95 €
130 - 200	4032980	588,25 €
150 - 250	4035398	880,75 €

El kit incluye los siguientes elementos: | The kit includes: | Le kit comprend les éléments suivants:

**1** Abrazadera forjado  
Ceiling bracket | Collier support plancher

Ø 80 - 130
Ø 100 - 150
Ø 110 - 180
Ø 130 - 200
Ø 150 - 250

**3** Módulo extensible | Extendable element  
Élément télescopique 750-1350+2 joints

Ø 80 - 130
Ø 100 - 150
Ø 110 - 180
Ø 130 - 200
Ø 150 - 250

**+** Juntas | Gaskets | Joints

Ø 80 - 130
Ø 100 - 150 / Ø 110 - 180
Ø 130 - 200
Ø 150 - 250

**2** Módulo lineal | Linear module | Élément droit  
1000 mm+2x2 juntas | gaskets | joints

Ø 80 - 130
Ø 100 - 150
Ø 110 - 180
Ø 130 - 200
Ø 150 - 250

2 unidades | units | unités



Puede encontrar estos módulos en las secciones concéntricas de esta tarifa.  
You can find these modules in the concentric sections of this price list.  
Vous pouvez trouver ces modules dans les sections concentriques de ce tarif.

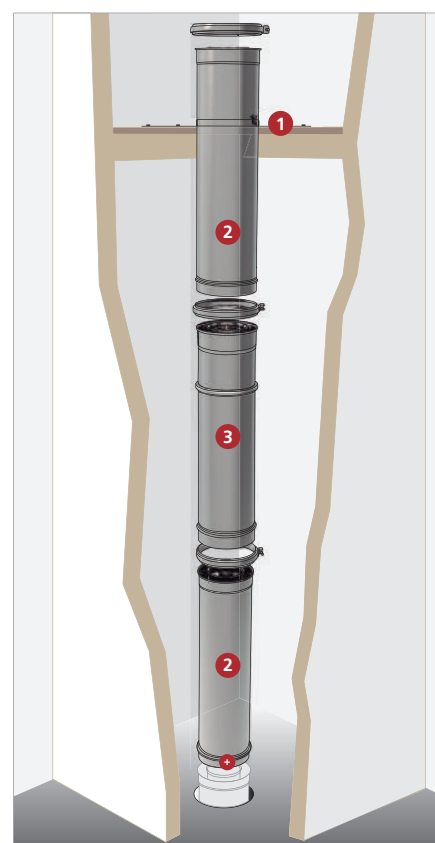

# 4

# EI

Resistencia al fuego EI

Fire resistance EI

Résistance au feu EI

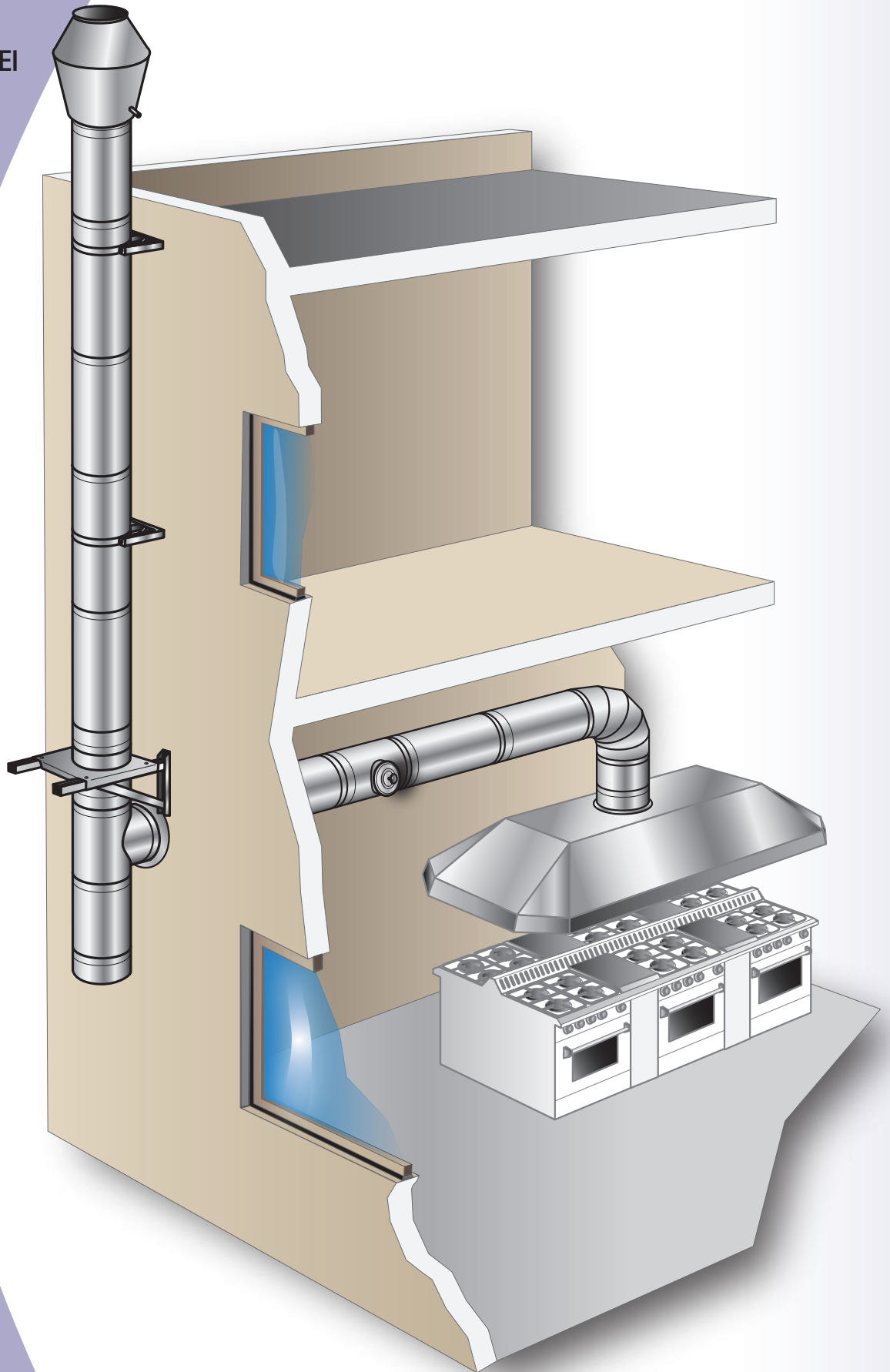



**CE** Especificaciones de acuerdo a la legislación europea en productos de construcción **CPR**  
 Specifications according to EU product regulations of construction **CPR**  
*Spécifications Selon la réglementation européenne concernant les produits de construction **CPR***

Espesor Thickness Épaisseur		Ø130-250 ..... <b>0,4 mm</b>
		Ø300-400 ..... <b>0,5 mm</b>
		Ø450-650 ..... <b>0,6 mm</b>

Aislante Insulation Isolation		25 mm	Lana de roca Rock wool Laine de roche
-------------------------------------	---	-------	---



interior y exterior | inside and outside | *intérieur et extérieur*

**AISI 304**

(1.4301) **2R**

**EN 1856-1**

T200 P1 W Vm L20040 O(15)

T200 N1 W Vm L20040 O(15)

T450 N1 W Vm L20040 O(40)

T600 N1 W Vm L20040 O(45)

T600 N1 D Vm L20040 G(70)

**Notas: | Notes:**

Para diámetros superiores a Ø300 mm, la distancia a los materiales combustibles se debe incrementar mediante un coeficiente.

For diameters more than Ø300 mm, the distance to combustible materials must be increased by a coefficient.

*Pour les diamètres supérieurs à Ø300 mm, la distance par rapport aux matériaux combustibles doit être augmentée par un coefficient.*

**XX Distancia | Distance:** x1,5 (Ø350-450)  
x2 (Ø500-600)  
x3 (Ø650)

\* Para cumplir con la clasificación EI todos los elementos deben estar instalados con juntas, consulte la página 92. Para saber el número de juntas, consulte la página 142.

\* To comply with EI classification, all elements must be installed with gaskets, see page 92. For the number of gaskets, see page 142.

\* *Pour respecter la classification EI, tous les éléments doivent être installés avec des joints, voir page 92. Unités de joints par élément, voir page 142.*

### Módulo lineal | Linear module | Élément droit



1000



500



250

ØDi mm **130 150 180 200 250 300 350 400**

#### L 1000 mm

AISI 304-304	Ref.	2700104	2700172	2700226	2700275	2700334	2700390	2700427	4027339
	€ U.	<b>100,10</b>	<b>107,95</b>	<b>125,60</b>	<b>136,65</b>	<b>191,65</b>	<b>248,90</b>	<b>274,50</b>	<b>351,70</b>

#### L 500 mm

AISI 304-304	Ref.	2700103	2700171	2700225	2700274	2700333	2700389	2700426	4032126
	€ U.	<b>63,25</b>	<b>67,95</b>	<b>75,80</b>	<b>81,55</b>	<b>107,00</b>	<b>134,05</b>	<b>166,70</b>	<b>209,65</b>

#### L 250 mm

AISI 304-304	Ref.	2700102	2700170	2700224	2700273	2700332	2700388	2700425	4032118
	€ U.	<b>49,15</b>	<b>50,30</b>	<b>58,85</b>	<b>63,75</b>	<b>92,55</b>	<b>103,30</b>	<b>127,80</b>	<b>173,10</b>

### Módulo extensible | Extendable module | Élément télescopique



500-900



335-565



200-300

ØDi mm **130 150 180 200 250 300 350 400**

#### Lmin 500 mm - Lmax 900 mm

AISI 304-304	Ref.	2700100	2700168	2700222	2700271	2700331	2700386	2700424	4032446
	€ U.	<b>152,25</b>	<b>153,85</b>	<b>184,25</b>	<b>198,45</b>	<b>290,50</b>	<b>320,20</b>	<b>419,80</b>	<b>477,45</b>

#### Lmin 335 mm - Lmax 565 mm

AISI 304-304	Ref.	2700098	2700166	2700220	2700269	2700329	2700385	2700423	4032435
	€ U.	<b>113,10</b>	<b>116,75</b>	<b>128,55</b>	<b>144,95</b>	<b>179,95</b>	<b>228,70</b>	<b>284,55</b>	<b>343,25</b>

#### Lmin 200 mm - Lmax 300 mm

AISI 304-304	Ref.	2700101	2700169	2700223	2700272	4007715	2700387	4022030	4032452
	€ U.	<b>79,00</b>	<b>84,45</b>	<b>99,95</b>	<b>127,50</b>	<b>159,15</b>	<b>181,35</b>	<b>254,15</b>	<b>329,00</b>

### Codo | Elbow | Coude 15°



ØDi mm **130 150 180 200 250 300 350 400**

AISI 304-304	Ref.	4015145	4015146	4015147	4015148	4015149	4015150	4015151	4032574
	€ U.	<b>62,30</b>	<b>68,75</b>	<b>88,00</b>	<b>94,95</b>	<b>117,30</b>	<b>173,55</b>	<b>218,75</b>	<b>332,00</b>

#### Medidas | Measurements | Mesures

	H	11	12	12	13	13	14	15	30
V		130	132	136	139	145	152	158	278

### Codo | Elbow | Coude 30°



ØDi mm **130 150 180 200 250 300 350 400**

AISI 304-304	Ref.	2700094	2700162	2700215	2700264	2700324	2700380	2700419	4032575
	€ U.	<b>62,30</b>	<b>68,75</b>	<b>88,00</b>	<b>94,95</b>	<b>117,30</b>	<b>173,55</b>	<b>218,75</b>	<b>332,00</b>

#### Medidas | Measurements | Mesures

	H	28	29	32	33	36	40	43	89
V		148	153	161	166	178	191	203	383



Ref.	2700172	Unidades de embalaje Packing units Unités d'emballage
€ U.	107,95 1	



Abrazadera de unión incluida en todas las piezas.  
Connection bracket included in all parts.  
Collier de fixation inclus dans tous les pièces.

**450    500    550    600    650**

4007145	4032136	4032137	4032138	4032139
405,80 1	458,35 1	522,35 1	602,35 1	690,80 1

4032128	4032132	4032133	4032134	4032135
247,60 1	297,65 1	353,85 1	424,10 1	469,20 1

4032121	4032122	4032123	4032124	4032125
213,45 1	284,95 1	329,25 1	388,10 1	416,60 1

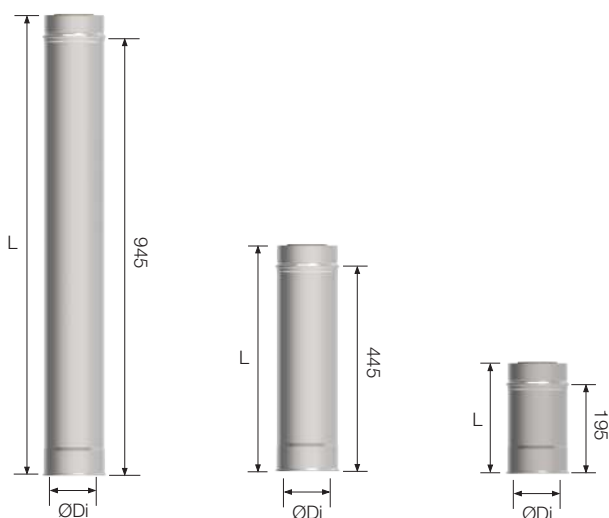

**450    500    550    600    650**

4032447	4032448	4032449	4032450	4032451
553,75 1	603,10 1	662,15 1	712,45 1	776,00 1

4032436	4032441	4032443	4032444	4032445
402,65 1	460,65 1	538,05 1	575,90 1	628,30 1

4032453	4032454	4032459	4032460	4032461
383,85 1	458,45 1	518,70 1	558,00 1	611,15 1

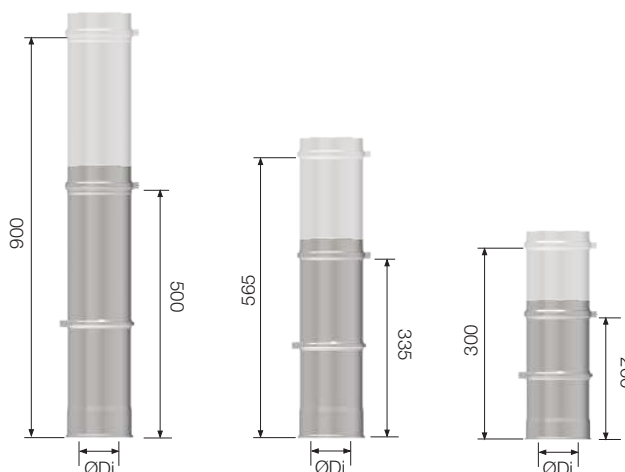

**450    500    550    600    650**

4032568	4032569	4032571	4032572	4032573
395,10 1	470,10 1	585,20 1	718,30 1	839,15 1

31	32	33	34	35
285	291	298	304	311

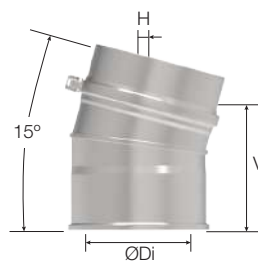

**450    500    550    600    650**

4032558	4032559	4032560	4032566	4032567
395,10 1	470,10 1	585,20 1	718,30 1	839,15 1

93	97	100	103	107
396	409	421	434	446

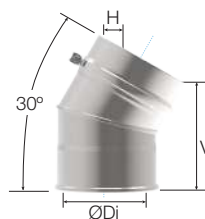

4

Codo | Elbow | Coude **45°**



		ØDi mm								
		130	150	180	200	250	300	350	400	
AISI <b>304-304</b>	Ref.	2700095	2700163	2700217	2700265	2700325	2700381	2700420	2500154	
	€ U.	<b>65,85</b> 1	<b>72,80</b> 1	<b>93,05</b> 1	<b>100,40</b> 1	<b>124,15</b> 1	<b>183,65</b> 1	<b>236,45</b> 1	<b>344,90</b> 1	

Medidas | Measurements | Mesures

<b>H</b>	47	50	54	57	63	70	77	151	
<b>V</b>	161	167	178	185	202	219	236	416	

Codo | Elbow | Coude **90°**



		ØDi mm								
		130	150	180	200	250	300	350	400	
AISI <b>304-304</b>	Ref.	4021730	4021731	4021732	4021733	4021734	4021735	4021736	4025335	
	€ U.	<b>140,10</b> 1	<b>152,00</b> 1	<b>173,30</b> 1	<b>201,75</b> 1	<b>241,15</b> 1	<b>297,75</b> 1	<b>405,30</b> 1	<b>486,85</b> 1	

Medidas | Measurements | Mesures

<b>H</b>	137	146	160	170	194	217	241	388	
<b>V</b>	187	197	212	222	247	272	297	482	

Te | "T" piece | Té **90° \***



		ØDi mm								
		130	150	180	200	250	300	350	400	
AISI <b>304-304</b>	Ref.	4021802	4021803	4021804	4021805	4021807	4021809	4021810	4029494	
	€ U.	<b>107,40</b> 1	<b>109,65</b> 1	<b>133,15</b> 1	<b>146,95</b> 1	<b>197,60</b> 1	<b>280,45</b> 1	<b>350,75</b> 1	<b>609,65</b> 1	

Medidas | Measurements | Mesures

<b>L</b>	295	315	345	365	445	465	515	650	
<b>H</b>	169	179	194	204	244	254	279	295	
<b>V</b>	183	193	208	218	243	268	293	350	

Te | "T" piece | Té **135° \***



		ØDi mm								
		130	150	180	200	250	300	350	400	
AISI <b>304-304</b>	Ref.	4021774	4021776	4021778	4021779	4021780	4021781	4021782	4033751	
	€ U.	<b>161,85</b> 1	<b>189,15</b> 1	<b>194,40</b> 1	<b>234,70</b> 1	<b>367,60</b> 1	<b>456,90</b> 1	<b>499,00</b> 1	<b>828,10</b> 1	

Medidas | Measurements | Mesures

<b>L</b>	368	395	435	465	535	605	675	600	
<b>H</b>	225	243	268	285	328	371	413	436	
<b>V</b>	68	76	86	93	111	129	146	178	

Ref.	2700163	Unidades de embalaje Packing units Unités d'emballage
€ U.	72,80 1	



**Abrazadera de unión incluida en todas las piezas.**  
 Connection bracket included in all parts.  
*Collier de fixation inclus dans tous les pièces.*

450	500	550	600	650
4032552	4032554	4032555	4032556	4032557
<b>418,05</b> 1	<b>495,45</b> 1	<b>632,60</b> 1	<b>777,00</b> 1	<b>907,10</b> 1

159	166	173	181	188
434	451	469	487	504

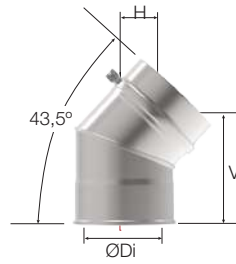

450	500	550	600	650
4032545	4032548	4032549	4032550	4032551
<b>726,00</b> 1	<b>907,50</b> 1	<b>1.268,40</b> 1	<b>1.539,95</b> 1	<b>1.798,60</b> 1

413	438	463	488	513
507	532	557	582	607

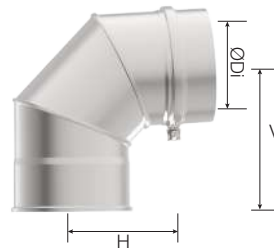

450	500	550	600	650
4029549	4029665	4029790	4030008	4030099
<b>784,65</b> 1	<b>943,85</b> 1	<b>1.091,50</b> 1	<b>1.239,15</b> 1	<b>1.417,70</b> 1

700	750	800	850	900
320	345	370	395	420
375	400	425	450	475



\* No incluye tapa  
 Cover not included  
*Couvercle non inclus*

450	500	550	600	650
4033753	4033754	4033755	4033756	4033757
<b>990,40</b> 1	<b>1.194,90</b> 1	<b>1.369,85</b> 1	<b>1.543,30</b> 1	<b>1.840,95</b> 1

650	700	750	850	900
464	492	519	583	611
189	201	213	238	251



\* No incluye tapa  
 Cover not included  
*Couvercle non inclus*

### Tapa | Cap | Tampon



		ØDi mm							
		130	150	180	200	250	300	350	400
AISI <b>316L-304</b>	Ref.	4015937	4015938	4015939	4015940	4015941	4015942	4015954	4029491
	€ U.	45,60 1	46,20 1	55,40 1	57,95 1	72,35 1	103,80 1	138,00 1	176,35 1

### Tapa purga | Condensate cap | Tampon récupérateur condensats



		ØDi mm							
		130	150	180	200	250	300	350	400
AISI <b>316L-304</b>	Ref.	4015943	4015952	4015944	4015867	4015945	4013919	4014409	4029489
	€ U.	46,95 1	47,70 1	56,50 1	59,75 1	74,60 1	107,00 1	142,25 1	193,70 1

Medidas | Measurements | Mesures

	H	30	30	30	30	30	30	30	147
	ØG	1/2"	1/2"	3/4"	3/4"	3/4"	1"	1"	1"

### Módulo de inspección | Inspection module | Module d'inspection \*



		ØDi mm							
		130	150	180	200	250	300	350	400
AISI <b>304-304</b>	Ref.	4021850	4021851	4021852	4021853	4021854	4021855	4021856	4040308
	€ U.	159,95 1	164,85 1	196,30 1	219,10 1	239,75 1	413,05 1	465,45 1	594,95 1

Medidas | Measurements | Mesures

	L	295	315	345	365	445	465	441	435
	ØT	130	150	180	200	250	200	200	200

### Tapa de inspección | Inspection cover | Trappe d'inspection 200°C / 200 Pa



Resistente a condensados  
Condensate-resistant  
Résistante aux condensats

		ØDi mm							
		130	150	180	200	250	300	350	400
AISI <b>304</b>	Ref.	5003267	5003268	5003269	5003270	5003271	5003270		
	€ U.	30,70 1	33,85 1	44,50 1	48,15 1	70,75 1	48,15 1		

Medidas | Measurements | Mesures

	ØT	130	150	180	200	250	200		
--	----	-----	-----	-----	-----	-----	-----	--	--

### Tapa de inspección | Inspection cover | Trappe d'inspection 450°C / 40 Pa



Para combustibles sólidos  
For solid fuels  
Pour combustibles solides

		ØDi mm							
		130	150	180	200	250	300	350	400
AISI <b>304</b>	Ref.	5003393	5003394	5003395	5003396	5003397	5003396		
	€ U.	47,10 1	52,60 1	60,45 1	66,75 1	98,90 1	66,75 1		

Medidas | Measurements | Mesures

	ØT	130	150	180	200	250	200		
--	----	-----	-----	-----	-----	-----	-----	--	--

### Pasamuros | Wall bushing | Traversée de mur



		ØDi mm							
		130	150	180	200	250	300	350	400
AISI <b>304-304</b>	Ref.	4023650	4023651	4023652	4023653	4023654	4023655	4023656	4023657
	€ U.	381,75 1	402,95 1	453,20 1	506,30 1	583,75 1	669,25 1	767,30 1	887,95 1

Ref.	4015938	Unidades de embalaje Packing units Unités d'emballage
€ U.	46,20 1	



Abrazadera de unión incluida en todas las piezas.  
Connection bracket included in all parts.  
Collier de fixation inclus dans tous les pièces.

450	500	550	600	650
4029540	4029666	4029784	4030005	4030091
206,80 1	218,05 1	231,70 1	263,45 1	297,55 1

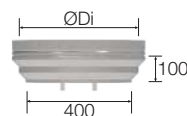
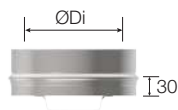

450	500	550	600	650
4029539	4029664	4029783	4030001	4030089
232,55 1	245,40 1	261,65 1	296,35 1	334,70 1

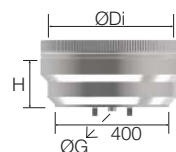
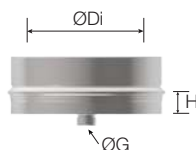

184	210	234	260	284
1"	1"	1"	1"	1"

450	500	550	600	650
4040315	4040316	4040317	4040318	4040319
741,45 1	842,05 1	970,20 1	1.087,25 1	1.233,15 1



\* No incluye tapa  
Cover not included  
Couvercle non inclus

405	405	405	405	405
200	200	200	200	200

450	500	550	600	650
5003270				
48,15 1				

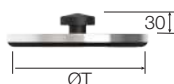

200				
-----	--	--	--	--

450	500	550	600	650
5003396				
66,75 1				

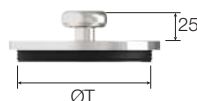

200				
-----	--	--	--	--

450	500	550	600	650
4023658	4023659	4023660	4023661	4023664
1.013,85 1	1.137,10 1	1.227,20 1	1.353,10 1	1.445,85 1

Sifón | Siphon | Siphon

Ref.	4030741
€ U.	41,00 1

max. 160° C

4

Sombrero antilluvia | Rain cap | *Chapeau pare-pluie*



		ØDi mm							
		130	150	180	200	250	300	350	400
AISI 304-304	Ref.	2700106	2700174	2700228	2700277	2700336	2700392	2700879	4009184
	€ U.	62,05	62,85	80,55	85,80	107,20	177,90	220,45	299,45

Medidas | Measurements | Mesures

V	103	103	103	103	141	141	141	151
ØDs	300	300	350	350	450	500	550	600

Sombrero bicónico | Jet cap | *Chapeau jet*



		ØDi							
		130	150	180	200	250	300	350	400
AISI 304-304	Ref.	4040460	4040461	4040462	4040463	4040464	4040465	4040466	4040467
	€ U.	560,90	695,05	774,35	781,80	907,35	1.230,00	1.332,25	1.500,45

Medidas | Measurements | Mesures

ØDS	155	180	215	240	300	360	420	480
ØDC	233	268	313	353	440	525	615	700
V	357	387	437	467	547	627	707	787

Sombrero salida libre | Exhaust high cone | *Cône de finition haute*



		ØDi mm							
		130	150	180	200	250	300	350	400
AISI 304-304	Ref.	2700108	2700176	2700230	2700279	2700338	2700393	2700428	4012752
	€ U.	74,50	82,80	96,85	110,15	145,45	195,15	241,50	258,95

Sombrero pico flauta | Flute peak cap | *Chapeau de flûte*



		ØDi mm							
		130	150	180	200	250	300	350	400
AISI 316L-304	Ref.	4007530	4008294	4008296	4008895	4011343	4007465	4007903	4007904
	€ U.	108,05	123,35	138,20	142,15	156,55	222,20	239,10	278,00

Medidas | Measurements | Mesures

L	105	105	105	105	105	105	105	180
---	-----	-----	-----	-----	-----	-----	-----	-----

Adaptador a campana | Hood adapter | *Adaptateur pour hotte*



		ØDi							
		130	150	180	200	250	300	350	400
AISI 304-304	Ref.	4033000	4033001	4033002	4033003	4033004	4033005	4033006	4033007
	€ U.	95,65	102,85	112,60	135,40	158,45	183,55	225,35	277,30

Medidas | Measurements | Mesures

Ød2	163	183	208	239	289	339	389	441
Ød3	183	203	228	263	313	363	413	473
qxØt	5x7	5x7	6x7	6x9	8x9	10x9	12x9	12x9

Adaptador SP - DP | SW - DW Adapter | *Adaptateur SP - DP*



		ØDi mm							
		130	150	180	200	250	300	350	400
AISI 304-304	Ref.	2700092	2700160	2700213	2700262	2700322	2700825	4008960	4027340
	€ U.	46,15	50,05	62,40	66,10	83,15	132,15	161,25	174,60

Adaptador DP - SP | DW - SW Adapter | *Adaptateur DP - SP*



		ØDi mm							
		130	150	180	200	250	300	350	400
AISI 304-304	Ref.	2700090	2700158	2700211	2700260	2700320	2700823	2700876	4033500
	€ U.	46,15	50,05	62,40	66,10	83,15	132,15	161,25	174,60

Medidas | Measurements | Mesures

L	160	160	160	160	160	160	160	240
---	-----	-----	-----	-----	-----	-----	-----	-----

Ref.	2700174	Unidades de embalaje Packing units Unités d'emballage
€ U.	62,85 1	



Abrazadera de unión incluida en todas las piezas.  
Connection bracket included in all parts.  
Collier de fixation inclus dans tous les pièces.

450	500	550	600	650
4040361	4040002	4040362	4040363	4040364
344,60 1	413,10 1	501,65 1	596,90 1	704,10 1

151	151	151	151	151
650	700	750	800	850

450	500	550	600	650
4040468	4040469	4040470	4040471	4040472
1.811,55 1	1.956,05 1	2.170,45 1	2.281,15 1	2.492,20 1

540	600	660	720	780
790	885	980	1075	1165
867	947	1027	1107	1360

450	500	550	600	650
4040375	4040376	4040377	4040378	4040379
274,65 1	334,65 1	405,05 1	544,60 1	644,65 1

450	500	550	600	650
4007905	4007906	4007907	4007908	4007909
350,80 1	386,95 1	499,85 1	553,40 1	620,20 1

180	180	180	180	180
-----	-----	-----	-----	-----

450	500	550	600	650
4033008	4033009	4033010	4033011	4033012
294,35 1	314,25 1	349,05 1	380,10 1	414,40 1

491	541	591	641	691
523	573	623	673	723
14x9	14x9	16x9	18x9	18x9

450	500	550	600	650
4029558	4029678	4029817	4030015	4030106
193,65 1	222,55 1	277,40 1	332,30 1	382,80 1

450	500	550	600	650
4033501	4033502	4033503	4033504	4033505
193,65 1	222,55 1	277,40 1	332,30 1	382,80 1

240	240	240	240	240
-----	-----	-----	-----	-----

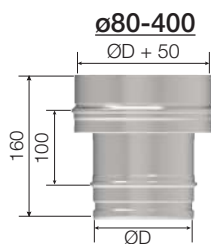
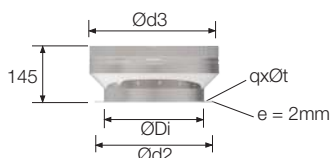
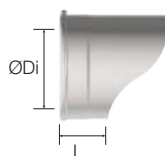
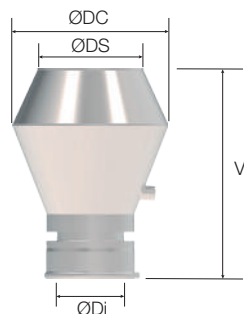
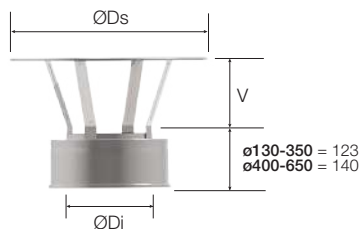

ø450 - 700

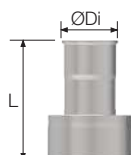
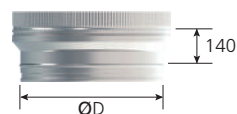

4

Abrazadera de unión clip | Pipe fast locking bracket | *Collier de fixation à clip*



		ØDi mm		130	150	180	200	250	300	350
AISI 304	Ref.	5003977	5003978	5003988	5003979	5003981	5003982	5003982	5003983	
	€ U.	7,75 1	7,95 1	8,05 1	10,60 1	11,65 1	12,80 1	10,95 1		
		ØDe mm		180	200	230	250	300	350	400

Junta silicona | Silicone gasket | *Joint silicone*



		ØDi mm		130	150	180	200	250	300	350	400
	Ref.	5003951	5003952	5003953	5003954	5003957	5003958	5003959	5003960		
	€ U.	1,95 10	2,60 10	3,75 10	4,15 10	5,60 10	7,60 5	10,30 5	12,90 5		

Junta Clase D | Class D gasket | *Joint Classe D*



		ØDi mm		130	150	180	200	250	300	350	400
	Ref.	-	-	-	-	5003921	5003922	5003923	5003924		
	€ U.	-	-	-	-	9,40 5	10,15 5	16,90 1	22,50 5		

Junta cerámica autoadhesiva | Self-adhesive ceramic gasket | *Joint autoadhésif en céramique 600° C*



Ref.	2053351
€ m.	3,50 1

Medidas | Measurements | Mesures

	Ø m	80	100	110	125	130	150	180	200
m (desarrollo   unfolding   déroulage)		0,25	0,31	0,35	0,39	0,41	0,47	0,57	0,63

Abrazadera mural exterior | External wall bracket | *Collier support mural extérieur \**



Ø 130-300



Ø 350-650

		ØDi mm		130	150	180	200	250	300	350	400
AISI 304	Ref.	4019878	4019879	4019880	4019881	4019882	4020326	4020327	4031696		
	€ U.	58,95 1	60,90 1	67,55 1	70,25 1	109,70 1	156,30 1	163,15 1	187,75 1		
		ØDe mm		180	200	230	250	300	350	400	450

Abrazadera mural interior | Interior wall bracket | *Collier support mural intérieur \**



		ØDi mm		130	150	180	200	250	300	350	400
AISI 304	Ref.	2500040	2500041	5001351	2500042	2500043	2500510	2500044	4035019		
	€ U.	15,90 6	17,75 6	24,10 2	25,60 2	32,85 2	44,95 2	63,60 2	104,00 1		
		Medidas   Measurements   Mesures									
	A	150	150	190	190	230	230	-	-		
		ØDe mm		180	200	230	250	300	350	400	450

Abrazadera de vientos | Roof brace band | *Collier pour hauban*



		ØDi mm		130	150	180	200	250	300	350	400
AISI 304	Ref.	2700241	2700295	2700214	2700354	2700403	2700323	2700418	4014608		
	€ U.	37,70 3	39,80 3	40,75 1	49,15 1	67,75 1	75,25 1	85,70 1	95,20 1		
		ØDe mm		180	200	230	250	300	350	400	450

Abrazadera de suspensión horizontal | Horizontal suspension bracket | *Collier de suspension horizontale*



		ØDi mm		130	150	180	200	250	300	350	400
AISI 304	Ref.	5005630	5005631	5005632	5005633	5005634	5005635	5005636	5005637		
	€ U.	13,50 1	13,90 1	14,10 1	14,20 1	17,10 1	19,80 1	22,30 1	25,45 1		
		ØDe mm		180	200	230	250	300	350	400	450



Ref.	5003978	Unidades de embalaje Packing units Unités d'emballage
€ U.	7,75 1	

Abrazadera unión ancha | Wide connection bracket | Collier de fixation large

	ØDi mm	400	450	500	550	600	650	
	AISI 304	Ref.	5005567	5005568	5005569	5005570	5005571	5005572
	€ U.	20,95 1	23,10 1	24,95 1	26,65 1	28,80 1	30,95 1	
	ØDe mm	450	500	550	600	650	700	

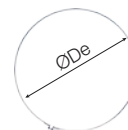

450	500	550	600	650
5005716	5005717	5005718	5005719	5005720
16,15 1	19,35 1	22,40 1	25,85 1	28,95 1

Lubricante silicona | Silicone lubricant | Graisse silicone



**150ml**

Ref.	5002932
€ U.	8,60 1

450	500	550	600	650
5003925	5003926	5003927	5003928	5003929
30,00 1	37,75 1	45,30 1	53,90 1	70,10 1

230	250	300	350	400
0,72	0,79	0,94	1,10	1,26

450	500	550	600	650
4031697	4031698	4031699	4031700	4031701
219,15 1	250,10 1	279,80 1	320,40 1	365,55 1
500	550	600	650	700

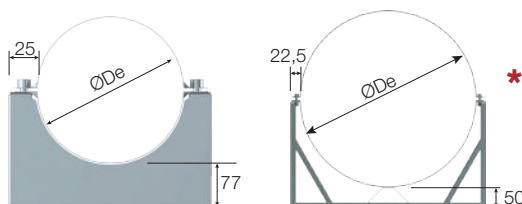

\* Opción regulable: añadir Prolongación mural (ver pág. 132)  
Adjustable option: add Wall extension (see page 132)  
Option réglable: ajouter Rallonge murale (voir page 132)

450	500	550	600	650
4035066	4035067	4035068	4035069	4035070
117,10 1	128,50 1	137,85 1	150,55 1	164,05 1

-	-	-	-	-
500	550	600	650	700

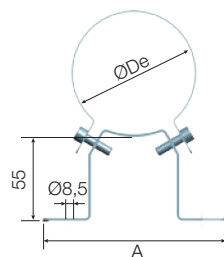

\* Opción regulable: añadir Prolongación mural (ver pág. 132)  
Adjustable option: add Wall extension (see page 132)  
Option réglable: ajouter Rallonge murale (voir page 132)

450	500	550	600	650
4014609	4014610	4014611	4014612	4014613
96,95 1	101,60 1	106,30 1	114,40 1	123,15 1
500	550	600	650	700



450	500	550	600	650
5005638	5005639	5005640	5005641	5005642
26,00 1	28,40 1	30,80 1	33,40 1	35,00 1
500	550	600	650	700

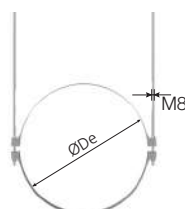

\* No incluye varillas de fijación ni tornillería necesaria  
Fixing rods and necessary screws not included  
Tiges de fixation et vis nécessaires non incluses

4

### Soporte mural intermedio | Intermediate wall support | Support mural intermédiaire \*



		ØDi mm							
		130	150	180	200	250	300	350	400
AISI <b>316L-304</b>	Ref.	4020109	4020110	4020111	4020112	4020113	4020114	4020115	4029487
	€ U.	<b>146,90</b>	<b>153,90</b>	<b>166,35</b>	<b>202,40</b>	<b>206,65</b>	<b>234,55</b>	<b>261,70</b>	<b>307,50</b>

\* No incluye escuadras | Square supports not included | Équerres de support non inclus

### Soporte mural universal | Universal wall support | Support mural universel \*



		ØDi mm							
		130	150	180	200	250	300	350	400
AISI <b>304</b>	Ref.	4026051	4026052	4026053	4026054	4026059	4026060	4026061	4026062
	€ U.	<b>93,70</b>	<b>101,75</b>	<b>111,00</b>	<b>119,20</b>	<b>145,75</b>	<b>168,85</b>	<b>189,40</b>	<b>242,05</b>

Medidas | Measurements | Mesures

<b>A</b>	213	233	263	283	333	383	435	485	
<b>B</b>	293	313	343	363	413	463	515	565	
ØDe mm		<b>180</b>	<b>200</b>	<b>230</b>	<b>250</b>	<b>300</b>	<b>350</b>	<b>400</b>	<b>450</b>

\* No incluye escuadras | Square supports not included | Équerres de support non inclus

### Escuadra de soporte (2 unidades) | Square support (2 units) | Équerre de support (2 unités)



		Pequeña* Small* Petit*	Mediana* Medium* Moyen*	Grande* Large* Grand*
AISI <b>304</b>	Ref.	4019925	4019926	4019927
	€ Kit	<b>70,65</b>	<b>94,25</b>	<b>122,35</b>

Medidas | Measurements | Mesures

<b>L</b>	245	360	515
<b>H</b>	290	430	610

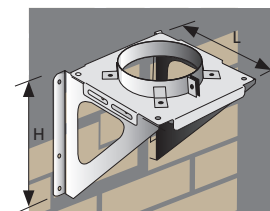

Escuadra con soporte mural  
Square with wall support  
Équerre avec support mural

\* Consultar el tamaño adecuado en la página 143 | Refer to the appropriate size on page 143 | Voir la taille appropriée à la page 143

### Escuadra de soporte reforzada (2 unidades) | Reinforced square support (2 units) | Équerre de support renforcé (2 unités)



		L	500 mm	750 mm	1000 mm
AISI <b>304</b>	Ref.	5003914	5003915	5003916	
	€ Kit	<b>194,95</b>	<b>257,35</b>	<b>292,50</b>	

Medidas | Measurements | Mesures

<b>H</b>	310	470	600
----------	-----	-----	-----

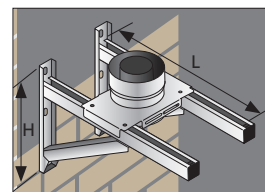

Escuadra reforzada con soporte mural  
Reinforced square with wall support  
Support renforcé avec support mural

\* Apto para Soporte mural universal e intermedio | Suitable for universal and intermediate wall supports | Convient pour le Support mural universel et intermédiaire

Ref.	4020110	Unidades de embalaje Packing units Unités d'emballage
€ U.	153,90 1	



Abrazadera de unión incluida en todas las piezas.  
Connection bracket included in all parts.  
Collier de fixation inclus dans tous les pièces.

450	500	550	600	650
4029538	4029663	4029776	4030000	4030083
345,80 1	408,00 1	501,55 1	606,65 1	776,70 1

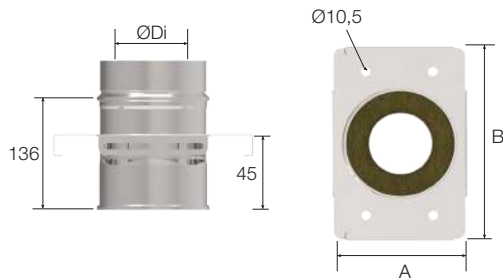

450	500	550	600	650
4026063	4026064	4026066	4026067	4026069
287,20 1	333,70 1	372,55 1	415,95 1	465,60 1

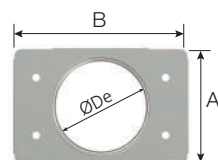

535	585	635	685	735
615	665	715	765	815
500	550	600	650	700

4

Soporte a techo regulable | Adjustable ceiling mounting | Support au toit réglable



		ØDi mm							
		130	150	180	200	250	300	350	400
AISI 304	Ref.	4013529	4012519	4013295	4012428	4015588	4015660	4014552	4040054
	€ U.	92,30 1	92,95 1	94,30 1	95,10 1	97,65 1	98,20 1	116,85 1	134,15 1
GALVA	Ref.	-	4012523	4012524	4012525	-	-	-	-
	€ U.	-	58,70 1	58,70 1	58,70 1	-	-	-	-
		ØDe mm							
		180	200	230	250	300	350	400	450

Abrazadera forjado | Ceiling bracket | Collier support plancher



Ø 130-180



Ø 200-650

		ØDi mm							
		130	150	180	200	250	300	350	400
AISI 304	Ref.	4022027	4011861	5001470	5001471	5001456	5001472	5001473	5001475
	€ U.	45,80 1	50,85 1	53,75 1	55,35 1	79,65 1	81,15 1	98,15 1	104,60 1
		ØDe mm							
		180	200	230	250	300	350	400	450

Abrazadera forjado reforzada | Reinforced ceiling bracket | Collier support plancher renforcé



		ØDi mm							
		130	150	180	200	250	300	350	400
AISI 304	Ref.	4026934	9023221	4026829	4023222	4023223	4023224	4023225	4023226
	€ U.	51,80 1	52,15 1	54,10 1	55,85 1	58,45 1	59,95 1	62,10 1	66,60 1
Medidas   Measurements   Mesures									
A		103	103	103	103	103	138	138	138
B		250	250	250	250	250	300	300	300
		ØDe mm							
		180	200	230	250	300	350	400	450

Abrazadera forjado universal | Universal ceiling bracket | Collier support plancher universel \*



1

		ØDi mm									
		80	100	125-130	150	180	200	250	300	350	400
AISI 304	Ref.	4026043	4026044	4026045	4026046	4026047	4026048	4026080	4026081	4026082	4040131
	€ U.	42,10 1	42,30 1	42,45 1	43,40 1	46,95 1	47,80 1	50,90 1	62,75 1	72,25 1	82,30 1
		ØDe mm									
		130	150	175-180	200	230	250	300	350	400	450

Ref.	4012519	Unidades de embalaje
€ U.	92,95 1	Packing units Unités d'emballage

450	500	550	600	650
4040055	4040056	4040057	4040058	4040059
138,40 1	142,65 1	146,85 1	162,75 1	168,75 1
-	-	-	-	-
-	-	-	-	-
500	550	600	650	700

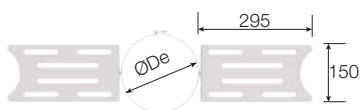

450	500	550	600	650
5001476	5001477	5001478	5001479	5001480
108,60 1	111,70 1	116,40 1	121,90 1	125,65 1
500	550	600	650	700

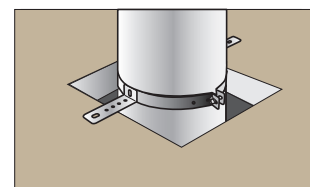
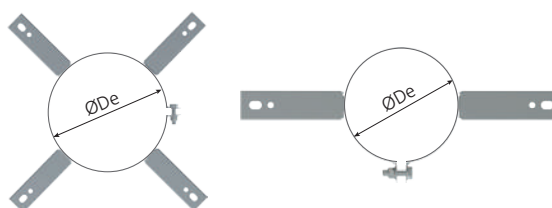

4

450	500	550	600	650
4026831	4026832	4026833	4026834	4026835
68,60 1	73,05 1	81,35 1	85,85 1	91,15 1
173	173	173	173	173
350	350	350	350	350
500	550	600	650	700

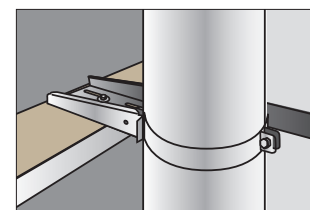
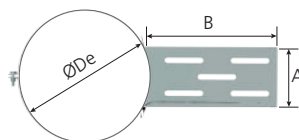

450	500	550	600	650
4040132	4040133	4040134	4040215	4040216
86,30 1	91,10 1	95,85 1	99,35 1	106,50 1
500	550	600	650	700

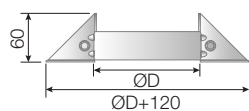

\* Consultar las diferentes opciones de soporte en las páginas 133 y 143.  
For support options, see pages 133 and 143.  
Pour les options de support, voir pages 133 et 143.

# 5 DP50

Doble Pared 50 mm  
50 mm Double Wall  
*Double Paroi 50 mm*

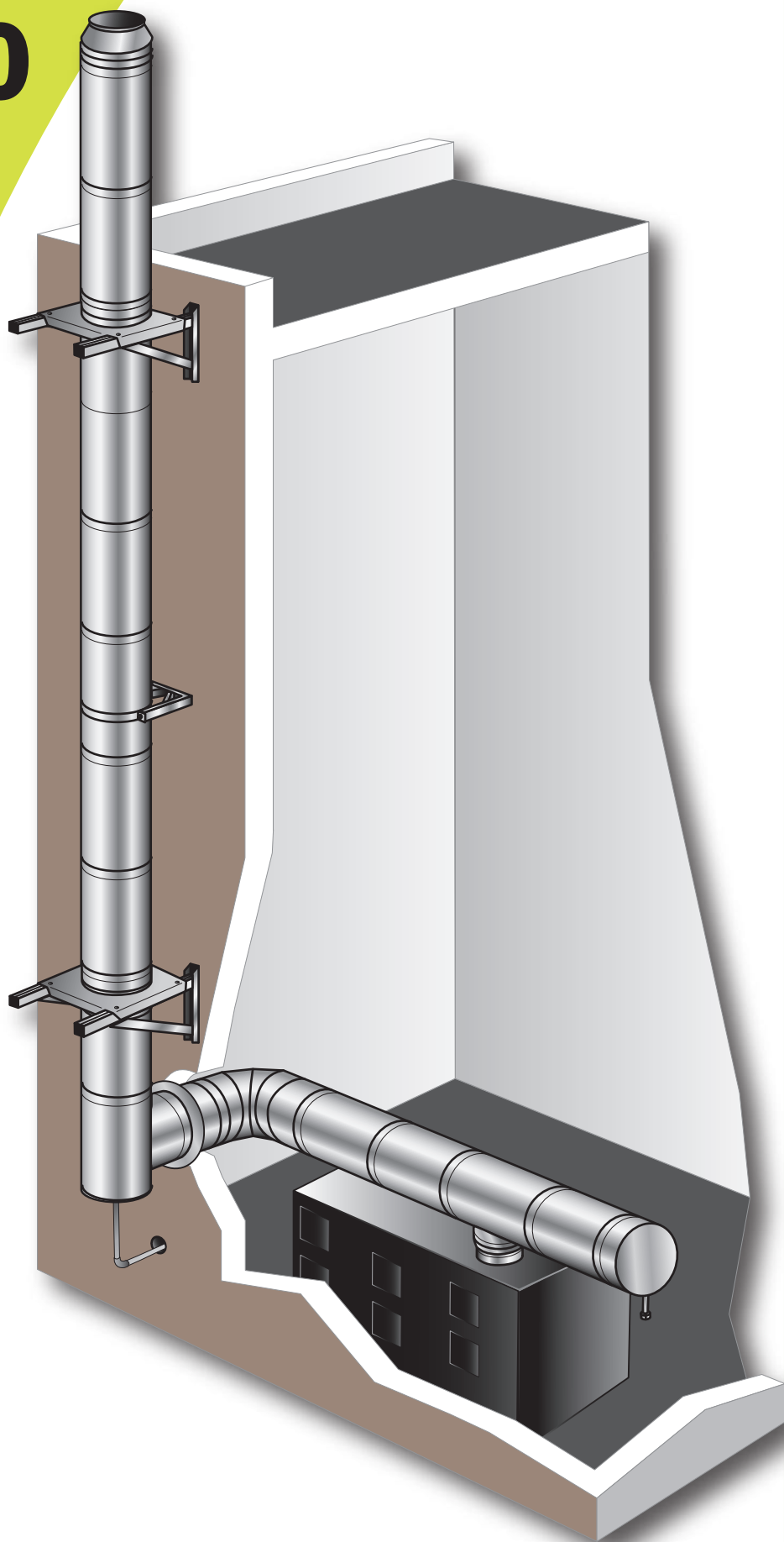

**CE** Especificaciones de acuerdo a la legislación europea en productos de construcción **CPR**  
 Specifications according to EU product regulations of construction **CPR**  
*Spécifications Selon la réglementation européenne concernant les produits de construction **CPR***

Espesor Thickness Épaisseur		Ø130-250 .....	<b>0,4 mm</b>
		Ø300-400 .....	<b>0,5 mm</b>
		Ø450-600 .....	<b>0,6 mm</b>

Espesor del aislante Insulation thickness Épaisseur d'isolation		50 mm	Lana de roca Rock wool Laine de roche
---	--	-------	---



interior y exterior | inside and outside | intérieur et extérieur

**AISI 304**

(1.4301) **2R**

**UNE-EN 1856-1 : 2010**

T200 P1 W Vm L20040 O(00)

T450 N1 W Vm L20040 O(15)

T600 N1 W Vm L20040 O(20)

T600 N1 D Vm L20040 G(45)



interior | inside | intérieur

exterior | outside | extérieur

\* **AISI 316L**

(1.4404) **2R**

**AISI 304**

(1.4301) **2R**

**UNE-EN 1856-1 : 2010**

\* Consultar Departamento Comercial  
 Consult Sales Department  
*Consulter le Département Commercial*

**Notas: | Notes:**

Productos con clasificación EI 30 y EI 45.  
 Products with EI 30 and EI 45 classification.  
*Produits classés EI 30 et EI 45.*

Para diámetros superiores a Ø300 mm, la distancia a los materiales combustibles se debe incrementar mediante un coeficiente.

For diameters more than Ø300 mm, the distance to combustible materials must be increased by a coefficient.

*Pour les diamètres supérieurs à Ø300 mm, la distance par rapport aux matériaux combustibles doit être augmentée par un coefficient.*

**XX Distancia | Distance: x1,5 (Ø350-450)  
 x2 (Ø500-600)**

**Junta incluida.**  
 Gasket included.  
*Joint inclus.*

### Módulo lineal | Linear module | Élément droit

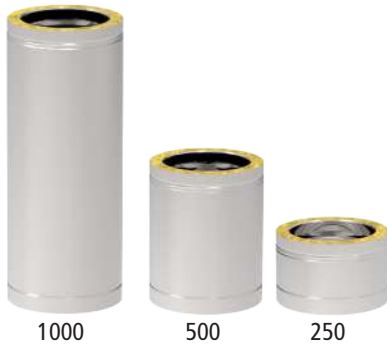

1000

500

250

ØDi mm **130 150 180 200 250 300 350 400**

#### L 1000 mm

AISI 304-304	Ref.	4500000	4500001	4500002	4500003	4500004	4500005	4500006	4500007
	€ U.	175,35	196,05	235,10	251,80	320,45	377,00	445,50	518,05

#### L 500 mm

AISI 304-304	Ref.	4500020	4500021	4500022	4500023	4500024	4500025	4500026	4500027
	€ U.	117,80	131,70	158,65	170,55	205,85	243,35	265,50	318,90

#### L 250 mm

AISI 304-304	Ref.	4500040	4500041	4500042	4500043	4500044	4500045	4500046	4500047
	€ U.	90,40	100,75	121,75	131,00	161,05	192,10	216,00	263,30

### Módulo extensible | Extendable module | Élément télescopique



500-900

335-565

200-300

ØDi mm **130 150 180 200 250 300 350 400**

#### Lmin 500 mm - Lmax 900 mm

AISI 304-304	Ref.	4500100	4500101	4500102	4500103	4500104	4500105	4500106	4500107
	€ U.	238,95	268,00	310,85	324,05	404,85	508,25	574,65	688,70

#### Lmin 335 mm - Lmax 565 mm

AISI 304-304	Ref.	4500080	4500081	4500082	4500083	4500084	4500085	4500086	4500087
	€ U.	171,45	191,25	228,35	243,75	301,20	354,30	401,55	485,25

#### Lmin 200 mm - Lmax 300 mm

AISI 304-304	Ref.	4500060	4500061	4500062	4500063	4500064	4500065	4500066	4500067
	€ U.	127,55	144,05	172,60	201,45	232,30	278,40	339,30	433,70

### Codo | Elbow | Coude 15°



ØDi mm **130 150 180 200 250 300 350 400**

AISI 304-304	Ref.	4500120	4500121	4500122	4500123	4500124	4500125	4500126	4500127
	€ U.	133,10	147,60	176,75	189,10	227,30	265,35	352,50	449,80

#### Medidas | Measurements | Mesures

	H	12	13	13	13	14	15	30	31
V	136	139	143	145	152	158	278	285	

### Codo | Elbow | Coude 30°



ØDi mm **130 150 180 200 250 300 350 400**

AISI 304-304	Ref.	4500140	4500141	4500142	4500143	4500144	4500145	4500146	4500147
	€ U.	133,10	147,60	176,75	189,10	227,30	265,35	352,50	449,80

#### Medidas | Measurements | Mesures

	H	32	33	35	36	40	43	90	93
V	161	166	173	178	191	203	384	396	

### Codo | Elbow | Coude 45°



ØDi mm **130 150 180 200 250 300 350 400**

AISI 304-304	Ref.	4500160	4500161	4500162	4500163	4500164	4500165	4500166	4500167
	€ U.	124,80	139,50	165,75	176,40	214,60	250,25	355,05	435,85

#### Medidas | Measurements | Mesures

	H	54	57	61	63	70	77	151	159
V	178	185	195	202	219	236	416	434	

### Codo | Elbow | Coude 90°



ØDi mm **130 150 180 200 250 300 350 400**

AISI 304-304	Ref.	4500180	4500181	4500182	4500183	4500184	4500185	4500186	4500187
	€ U.	212,05	236,65	282,20	300,95	370,50	457,15	592,60	825,95

#### Medidas | Measurements | Mesures

	H	212	222	237	247	272	297	427	451
V	160	170	184	194	217	241	482	507	



Ref.	4500001	Unidades de embalaje Packing units Unités d'emballage
€ U.	196,05 1	



**Abrazadera de unión incluida en todas las piezas.**  
Connection bracket included in all parts.  
*Collier de fixation inclus dans toutes les pièces.*



**Junta incluida.**  
Gasket included.  
*Joint inclus.*

**450 500 550 600**

4500008	4500009	4500010	4500011
565,25 1	628,95 1	694,15 1	803,20 1

4500028	4500029	4500030	4500031
348,05 1	419,10 1	488,35 1	548,60 1

4500048	4500049	4500050	4500051
295,15 1	343,65 1	372,50 1	432,75 1

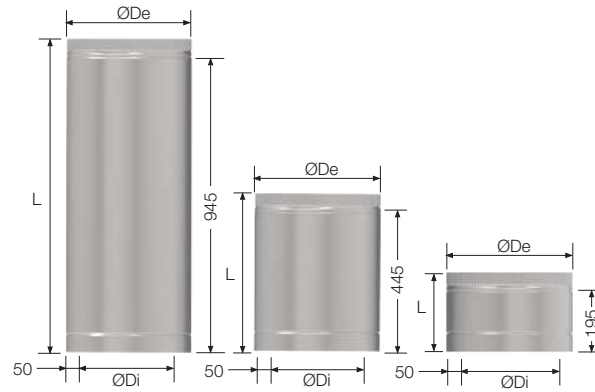

**450 500 550 600**

4500108	4500109	4500110	4500111
738,00 1	783,35 1	807,95 1	974,55 1

4500088	4500089	4500090	4500091
542,55 1	584,55 1	694,15 1	738,55 1

4500068	4500069	4500070	4500071
491,30 1	538,35 1	592,60 1	643,85 1

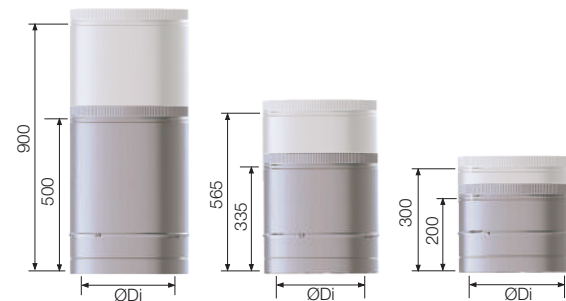

**450 500 550 600**

4500128	4500129	4500130	4500131
644,65 1	738,65 1	1.041,40 1	1.246,25 1

32	33	34	35
291	298	304	311

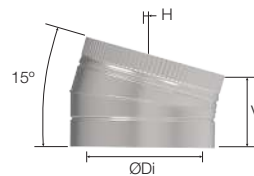

**450 500 550 600**

4500148	4500149	4500150	4500151
644,65 1	738,65 1	1.041,40 1	1.246,25 1

97	100	103	107
409	421	434	446

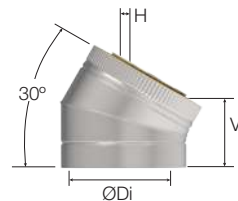

**450 500 550 600**

4500168	4500169	4500170	4500171
644,65 1	738,65 1	1.041,40 1	1.246,25 1

166	173	181	188
451	469	487	504

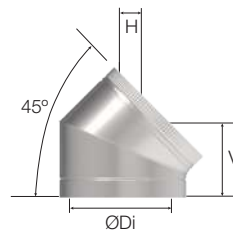

**450 500 550 600**

4500188	4500189	4500190	4500191
1.205,95 1	1.364,75 1	1.926,45 1	2.305,55 1

475	498	522	546
532	557	582	607

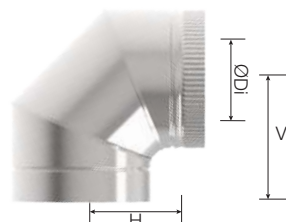

Te | "T" piece | Té **90° \***



		ØDi mm							
		130	150	180	200	250	300	350	400
AISI 304-304	Ref.	4500200	4500201	4500202	4500203	4500204	4500205	4500206	4500207
	€ U.	233,75	260,45	325,35	359,10	446,25	533,45	736,50	935,00

Medidas | Measurements | Mesures

	L	345	365	413	445	465	545	650	700
	H	208	218	233	243	268	293	294	320
	V	194	204	228	244	254	279	350	375

Te | "T" piece | Té **135° \***



		ØDi mm							
		130	150	180	200	250	300	350	400
AISI 304-304	Ref.	4500220	4500221	4500222	4500223	4500224	4500225	4500226	4500227
	€ U.	623,85	668,40	774,70	807,15	1.032,45	1.221,05	1.530,25	1.808,40

Medidas | Measurements | Mesures

	L	435	465	505	535	605	675	750	813
	H	268	285	311	328	371	413	458	500
	V	268	285	311	123	141	158	268	250

Tapa | Plug | Tampon



		ØDi mm							
		130	150	180	200	250	300	350	400
AISI 304-304	Ref.	4500240	4500241	4500242	4500243	4500244	4500245	4500246	4500247
	€ U.	83,25	84,65	101,00	107,65	121,75	142,00	183,15	219,10

Tapa purga | Purge plug | Tampon récupérateur condensats



		ØDi mm							
		130	150	180	200	250	300	350	400
AISI 304-304	Ref.	4500260	4500261	4500262	4500263	4500264	4500265	4500266	4500267
	€ U.	105,95	108,50	123,95	127,40	148,10	196,20	258,15	300,65

Medidas | Measurements | Mesures

	ØG	1/2"	3/4"	3/4"	3/4"	3/4"	1"	1"	1"
--	----	------	------	------	------	------	----	----	----

Módulo de inspección con tapa | Inspection module with cap | Module inspection avec tampon



		ØDi mm							
		130	150	180	200	250	300	350	400
AISI 304-304	Ref.	4500280	4500281	4500282	4500283	4500284	4500285	4500286	4500287
	€ U.	312,10	322,30	336,60	354,95	386,70	570,35	612,45	752,25

Medidas | Measurements | Mesures

	L	345	365	415	450	450	450	450	450
	ØT	130	150	180	200	250	200	200	200

Tapa de inspección | Inspection plug | Trappe d'inspection **200°C / 200 Pa**



Resistente a la humedad  
Moisture resistant  
Insensible à l'humidité

		ØDi mm							
		130	150	180	200	250	300	350	400
AISI 304	Ref.	5003267	5003268	5003269	5003270	5003271	5003270		
	€ U.	30,70	33,85	44,50	48,15	70,75	48,15		

Medidas | Measurements | Mesures

	ØT	130	150	180	200	250	200		
--	----	-----	-----	-----	-----	-----	-----	--	--

Tapa de inspección | Inspection plug | Trappe d'inspection **450°C / 40 Pa**



Para combustibles sólidos  
For solid fuels  
Pour combustibles solides

		ØDi mm							
		130	150	180	200	250	300	350	400
AISI 304	Ref.	5003393	5003394	5003395	5003396	5003397	5003396		
	€ U.	47,10	52,60	60,45	66,75	98,90	66,75		

Ref.	4500201	Unidades de embalaje Packing units Unités d'emballage
€ U.	260,45 <sup>1</sup>	



**Abrazadera de unión incluida en todas las piezas.**  
Connection bracket included in all parts.  
*Collier de fixation inclus dans toutes les pièces.*



**Junta incluida.**  
Gasket included.  
*Joint inclus.*

450	500	550	600
-----	-----	-----	-----

4500208	4500209	4500210	4500211
1.074,15 <sup>1</sup>	1.303,30 <sup>1</sup>	1.403,75 <sup>1</sup>	1.763,80 <sup>1</sup>

750	800	850	900
345	370	395	420
345	370	395	420

450	500	550	600
-----	-----	-----	-----

4500228	4500229	4500230	4500231
2.045,40 <sup>1</sup>	2.431,25 <sup>1</sup>	2.651,40 <sup>1</sup>	3.099,40 <sup>1</sup>

884	955	1025	1100
543	586	629	672
232	213	196	178

450	500	550	600
-----	-----	-----	-----

4500248	4500249	4500250	4500251
249,35 <sup>1</sup>	335,25 <sup>1</sup>	383,65 <sup>1</sup>	402,35 <sup>1</sup>

450	500	550	600
-----	-----	-----	-----

4500268	4500269	4500270	4500271
333,85 <sup>1</sup>	396,50 <sup>1</sup>	445,55 <sup>1</sup>	479,35 <sup>1</sup>

1"	1"	1"	1"
----	----	----	----

450	500	550	600
-----	-----	-----	-----

4500288	4500289	4500290	4500291
889,90 <sup>1</sup>	1.011,45 <sup>1</sup>	1.152,85 <sup>1</sup>	1.259,85 <sup>1</sup>

450	450	450	450
200	200	200	200

450	500	550	600
-----	-----	-----	-----

5003270			
48,15 <sup>1</sup>			

200			
-----	--	--	--

450	500	550	600
-----	-----	-----	-----

5003396			
66,75 <sup>1</sup>			

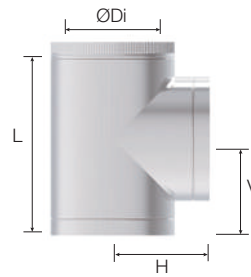

\* No incluye tapa  
Cover not included  
*Couvercle non inclus*

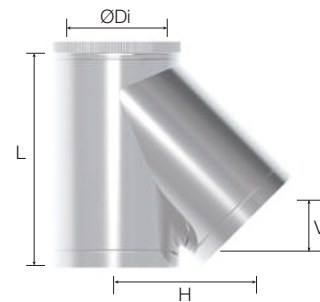

\* No incluye tapa  
Cover not included  
*Couvercle non inclus*

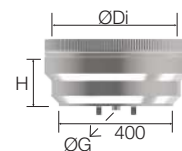
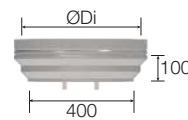

**Sifón | Siphon | Siphon**



Ref.	4030741
€ U.	41,00 <sup>1</sup>

max. 160° C

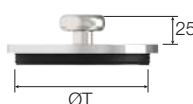
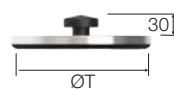

**5**

Sombrero antilluvia | Rain cap | *Chapeau pare-pluie*



		ØDi mm								
		130	150	180	200	250	300	350	400	
AISI 304-304	Ref.	4500300	4500301	4500302	4500303	4500304	4500305	4500306	4500307	
	€ U.	132,35 1	145,70 1	170,35 1	178,65 1	227,05 1	299,75 1	349,15 1	454,15 1	
Medidas   Measurements   Mesures										
V		143	143	143	180	180	193	193	193	
ØDs		350	400	450	500	550	600	650	700	

Sombrero bicónico | Jet cap | *Chapeau jet*



		ØDi mm								
		130	150	180	200	250	300	350	400	
AISI 304-304	Ref.	4500360	4500361	4500362	4500363	4500364	4500365	4500366	4500367	
	€ U.	735,55 1	919,00 1	1.013,75 1	1.036,85 1	1.231,90 1	1.633,50 1	1.750,95 1	1.976,20 1	
Medidas   Measurements   Mesures										
ØDS		155	180	215	240	300	360	420	480	
ØDC		233	268	313	353	440	525	615	700	
V		357	387	437	467	547	627	707	787	

Sombrero salida libre | Exhaust high cone | *Cône de finition haute*



		ØDi mm								
		130	150	180	200	250	300	350	400	
AISI 304-304	Ref.	4500320	4500321	4500322	4500323	4500324	4500325	4500326	4500327	
	€ U.	102,25 1	111,10 1	136,45 1	148,85 1	179,85 1	218,15 1	249,65 1	324,35 1	

Sombrero pico flauta | Lateral cap | *Chapeau de flûte*



		ØDi mm								
		130	150	180	200	250	300	350	400	
AISI 304-304	Ref.	4500340	4500341	4500342	4500343	4500344	4500345	4500346	4500347	
	€ U.	98,75 1	110,65 1	134,30 1	145,00 1	173,65 1	203,25 1	247,15 1	305,40 1	

Abrazadera unión ancha | Wide connection bracket | *Collier de fixation large*



		ØDi mm								
		130	150	180	200	250	300	350	400	
AISI 304	Ref.	5005363	5005364	5005363	5005364	5005365	5005366	5005367	5005368	
	€ U.	11,45 1	12,75 1	14,05 1	14,45 1	16,35 1	18,75 1	20,95 1	23,10 1	
ØDe		230	250	280	300	350	400	450	500	

Junta silicona | Silicone gasket | *Joint silicone*



		ØDi mm								
		130	150	180	200	250	300	350	400	
Ref.		5003951	5003952	5003953	5003954	5003957	5003958	5003959	5003960	
€ U.		1,95 10	2,60 10	3,75 10	4,15 10	5,60 10	7,60 5	10,30 5	12,90 5	

Junta cerámica autoadhesiva | Self-adhesive ceramic gasket | *Joint autoadhésif en céramique* 600° C



Ref.	2053351							
€ m.	3,50 1							
Medidas   Measurements   Mesures								
Ø m	80	100	110	125	130	150	180	200
m (desarrollo   unfolding   déroulage)	0,25	0,31	0,35	0,39	0,41	0,47	0,57	0,63

Ref.	4500301	Unidades de embalaje Packing units Unités d'emballage
€ U.	145,70 <sup>1</sup>	



**Abrazadera de unión incluida en todas las piezas.**  
Connection bracket included in all parts.  
*Collier de fixation inclus dans toutes les pièces.*



**Junta incluida.**  
Gasket included.  
*Joint inclus.*

450	500	550	600
4500308	4500309	4500310	4500311
513,30 <sup>1</sup>	625,60 <sup>1</sup>	722,35 <sup>1</sup>	828,00 <sup>1</sup>

193	193	193	193
750	800	850	900

450	500	550	600
4500368	4500369	4500370	4500371
2.404,85 <sup>1</sup>	2.606,15 <sup>1</sup>	2.885,85 <sup>1</sup>	3.025,80 <sup>1</sup>

540	600	660	720
790	885	980	1075
867	947	1027	1107

450	500	550	600
4500328	4500329	4500330	4500331
369,75 <sup>1</sup>	449,00 <sup>1</sup>	468,40 <sup>1</sup>	506,50 <sup>1</sup>

450	500	550	600
4500348	4500349	4500350	4500351
422,10 <sup>1</sup>	466,90 <sup>1</sup>	595,65 <sup>1</sup>	668,45 <sup>1</sup>

450	500	550	600
5005569	5005570	5005571	5005572
24,95 <sup>1</sup>	26,65 <sup>1</sup>	28,80 <sup>1</sup>	30,95 <sup>1</sup>
550	600	650	700

450	500	550	600
5005716	5005717	5005718	5005719
16,15 <sup>1</sup>	19,35 <sup>1</sup>	22,40 <sup>1</sup>	25,85 <sup>1</sup>

230	250	300	350	400
0,72	0,79	0,94	1,10	1,26

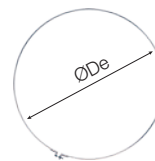
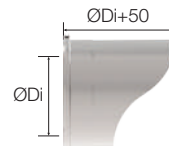
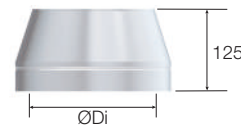
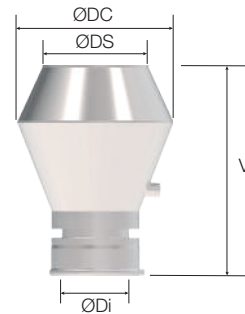
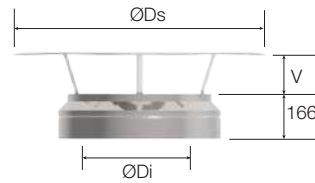

**5**

Lubricante silicona | Silicone lubricant | *Graisse silicone*



**150ml**

Ref.	5002932
€ U.	8,60 <sup>1</sup>

Adaptador a campana | Hood adapter | *Adaptateur pour hotte*



		ØDi mm							
		130	150	180	200	250	300	350	400
AISI <b>304-304</b>	Ref.	4500400	4500401	4500402	4500403	4500404	4500405	4500406	4500407
	€ U.	<b>106,20</b> 1	<b>114,30</b> 1	<b>125,05</b> 1	<b>150,40</b> 1	<b>176,05</b> 1	<b>203,80</b> 1	<b>250,50</b> 1	<b>299,75</b> 1
Medidas   Measurements   Mesures									
Ød2		163	183	208	239	289	339	389	441
Ød3		183	203	228	263	313	363	413	473
qxØt		5x7	5x7	6x7	6x9	8x9	10x9	12x9	12x9

Adaptador DP-DP50 | DW-DW50 adapter | *Adaptateur DP-DP50*



		ØDi mm							
		130	150	180	200	250	300	350	400
AISI <b>304-304</b>	Ref.	4500420	4500421	4500422	4500423	4500424	4500425	4500426	4500427
	€ U.	<b>113,70</b> 1	<b>118,20</b> 1	<b>133,35</b> 1	<b>156,35</b> 1	<b>195,15</b> 1	<b>243,70</b> 1	<b>257,55</b> 1	<b>309,50</b> 1

Adaptador DP50-DP | DW50-DW adapter | *Adaptateur DP50-DP*



		ØDi mm							
		130	150	180	200	250	300	350	400
AISI <b>304-304</b>	Ref.	4500440	4500441	4500442	4500443	4500444	4500445	4500446	4500447
	€ U.	<b>118,35</b> 1	<b>123,05</b> 1	<b>138,90</b> 1	<b>162,95</b> 1	<b>203,20</b> 1	<b>253,80</b> 1	<b>268,25</b> 1	<b>322,35</b> 1

Abrazadera mural exterior | External wall bracket | *Collier support mural extérieur \**



Ø130-300

Ø350-600

\* Opción regulable: añadir Prolongación mural (ver pág. 132)  
Adjustable option: add Wall extension (see page 132)  
*Option réglable: ajouter Rallonge murale (voir page 132)*

		ØDi mm							
		130	150	180	200	250	300	350	400
AISI <b>304</b>	Ref.	4019880	4019881	4031702	4019882	4020326	4020327	4031696	4031697
	€ U.	<b>67,55</b> 1	<b>70,25</b> 1	<b>89,40</b> 1	<b>109,70</b> 1	<b>156,30</b> 1	<b>163,15</b> 1	<b>187,75</b> 1	<b>219,15</b> 1
ØDe		230	250	280	300	350	400	450	500

Abrazadera mural interior | Interior wall bracket | *Collier support mural intérieur \**



Ø130-400

Ø450-600

\* Opción regulable: añadir Prolongación mural (ver pág. 132)  
Adjustable option: add Wall extension (see page 132)  
*Option réglable: ajouter Rallonge murale (voir page 132)*

		ØDi mm							
		130	150	180	200	250	300	350	400
AISI <b>304</b>	Ref.	5001351	2500042	-	2500043	2500510	2500044	4035019	4035066
	€ U.	<b>24,10</b> 2	<b>25,60</b> 2	-	<b>32,85</b> 2	<b>44,95</b> 2	<b>63,60</b> 2	<b>104,00</b> 1	<b>117,10</b> 1
Medidas   Measurements   Mesures									
A		190	230	-	230	300	300	-	-
B		-	-	-	-	-	-	-	-
ØDe		230	250	280	300	350	400	450	500

Abrazadera de vientos | Roof brace band | *Bride pour hauban*



		ØDi mm							
		130	150	180	200	250	300	350	400
AISI <b>304</b>	Ref.	2700214	2700354	4014614	2700403	2700323	2700418	4014608	4014609
	€ U.	<b>40,75</b> 1	<b>49,15</b> 1	<b>57,20</b> 1	<b>67,75</b> 1	<b>75,25</b> 1	<b>85,70</b> 1	<b>95,20</b> 1	<b>96,95</b> 1
ØDe		230	250	280	300	350	400	450	500

Ref.	4500401	Unidades de embalaje Packing units Unités d'emballage
€ U.	114,30 1	



**Abrazadera de unión incluida en todas las piezas.**  
Connection bracket included in all parts.  
*Collier de fixation inclus dans toutes les pièces.*



**Junta incluida.**  
Gasket included.  
*Joint inclus.*

450	500	550	600
-----	-----	-----	-----

4500408	4500409	4500410	4500411
318,25 1	339,80 1	377,35 1	410,90 1

491	541	591	641
523	573	623	673
14x9	14x9	16x9	18x9

450	500	550	600
-----	-----	-----	-----

4500428	4500429	4500430	4500431
337,35 1	424,05 1	441,40 1	462,25 1

450	500	550	600
-----	-----	-----	-----

4500448	4500449	4500450	4500451
351,35 1	441,70 1	459,75 1	481,40 1

450	500	550	600
-----	-----	-----	-----

4031698	4031699	4031700	4031701
250,10 1	279,80 1	320,40 1	365,55 1
550	600	650	700

450	500	550	600
-----	-----	-----	-----

4035067	4035068	4035069	4035070
128,50 1	137,85 1	150,55 1	164,05 1

-	-	-	-
-	-	-	-

550	600	650	700
-----	-----	-----	-----

450	500	550	600
-----	-----	-----	-----

4014610	4014611	4014612	4014613
101,60 1	106,30 1	114,40 1	123,15 1

550	600	650	700
-----	-----	-----	-----

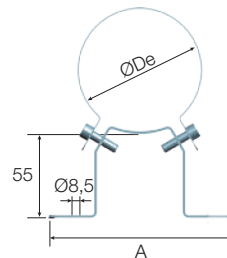
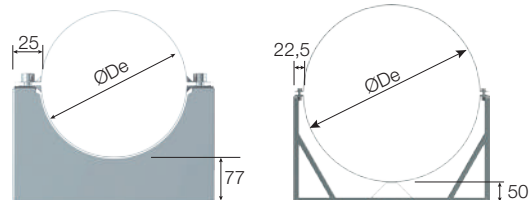
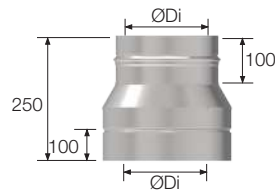
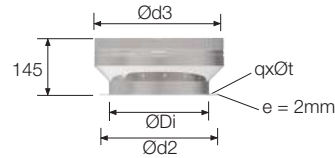

5

### Soporte mural intermedio | Intermediate wall support | Support mural intermédiaire \*



		ØDi mm							
		130	150	180	200	250	300	350	400
AISI 304-304	Ref.	4500380	4500381	4500382	4500383	4500384	4500385	4500386	4500387
	€ U.	178,70	185,70	190,05	249,15	277,85	331,50	442,40	452,70

Medidas | Measurements | Mesures

	A	263	283	313	333	383	433	483	533
	B	343	363	343	413	463	513	563	613

\* No incluye escuadras | Square supports not included | Équerres de support non inclus

### Soporte mural universal | Universal wall support | Support mural universel \*

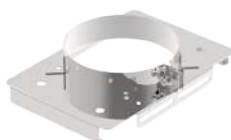

		ØDi mm							
		130	150	180	200	250	300	350	400
AISI 304	Ref.	4026053	4026054	4026058	4026059	4026060	4026061	4026062	4026063
	€ U.	111,00	119,20	135,10	145,75	168,85	189,40	242,05	287,20

Medidas | Measurements | Mesures

	A	263	283	313	333	383	435	485	535
	B	343	363	393	413	463	515	565	615

ØDe	230	250	280	300	350	400	450	500
-----	-----	-----	-----	-----	-----	-----	-----	-----

\* No incluye escuadras | Square supports not included | Équerres de support non inclus

### Escuadra de soporte (2 unidades) | Square support (2 units) | Équerre de support (2 unités)



		Pequeña* Small* Petit*	Mediana* Medium* Moyen*	Grande* Large* Grand*
AISI 304	Ref.	4019925	4019926	4019927
	€ Kit	70,65	94,25	122,35

Medidas | Measurements | Mesures

	L	245	360	515
	H	290	430	610

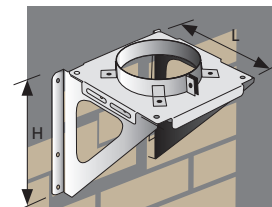

Escuadra con soporte mural  
Square with wall support  
Équerre avec support mural

\* Consultar el tamaño adecuado en la página 143 | Refer to the appropriate size on page 143 | Voir la taille appropriée à la page 143

### Soporte a techo regulable | Adjustable roof support | Support au toit réglable



		ØDi mm							
		130	150	180	200	250	300	350	400
AISI 304	Ref.	4013295	4012428	4040053	4015588	4015660	4014552	4040054	4040055
	€ U.	94,30	95,10	97,65	97,65	98,20	116,85	134,15	138,40

		ØDi mm							
		130	150	180	200	250	300	350	400
GALVA	Ref.	4012524	4012525	-	-	-	-	-	-
	€ U.	58,70	58,70	-	-	-	-	-	-

ØDe mm	230	250	280	300	350	400	450	500
--------	-----	-----	-----	-----	-----	-----	-----	-----



Ref.	4500381	Unidades de embalaje Packing units Unités d'emballage
€ U.	185,70 1	

450	500	550	600
4500388	4500389	4500390	4500391
525,45 1	586,75 1	738,90 1	860,40 1

583	633	683	733
663	713	763	813

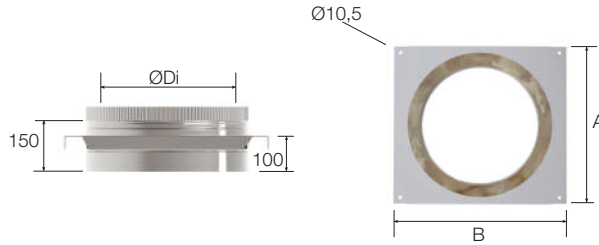

450	500	550	600
4026064	4026066	4026067	4026069
333,70 1	372,55 1	415,95 1	465,60 1

585	635	685	735
665	715	765	815
550	600	650	700

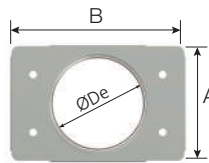

Escuadra de soporte reforzada (2 unidades) | Reinforced square support (2 units) | Équerre de support renforcé (2 unités)



		L	500 mm	750 mm	1000 mm
AISI 304	Ref.		5003914	5003915	5003916
	€ Kit		194,95 1	257,35 1	292,50 1
Medidas   Measurements   Mesures					
H			310	470	600

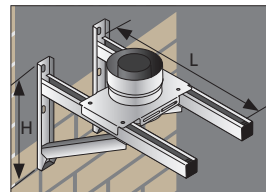

Escuadra reforzada con soporte mural  
Reinforced square with wall support  
Support renforcé avec support mural

\* Apta para Soporte mural universal e intermedio | Suitable for universal and intermediate wall supports | Convient pour le Support mural universel et intermédiaire

450	500	550	600
4040056	4040057	4040058	4040059
142,65 1	146,85 1	162,75 1	168,75 1

-	-	-	-
-	-	-	-

550	600	650	700
-----	-----	-----	-----

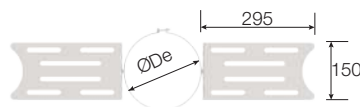

Abrazadera forjado | Ceiling bracket | *Collier support plancher*



		ØDi mm							
		130	150	180	200	250	300	350	400
AISI 304	Ref.	5001470	5001471	5001474	5001456	5001472	5001473	5001475	5001476
	€ U.	53,75	55,35	74,00	79,65	81,15	98,15	104,60	108,60
		ØDe							
		230	250	280	300	350	400	450	500

Abrazadera forjado reforzada | Reinforced ceiling bracket | *Collier support plancher renforcé*



		ØDi mm							
		130	150	180	200	250	300	350	400
AISI 304	Ref.	4026829	4023222	4026830	4023223	4023224	4023225	4023226	4026831
	€ U.	54,10	55,85	56,45	58,45	59,95	62,10	66,60	68,60
		Medidas   Measurements   Mesures							
		A	103	103	138	138	138	138	173
		B	250	250	300	300	300	300	350
		ØDe							
		230	250	280	300	350	400	450	500

Abrazadera forjado universal | Universal ceiling bracket | *Collier support plancher universel* \*



		ØDi mm							
		130	150	180	200	250	300	350	400
AISI 304	Ref.	4026043	4026044	4026045	4026046	4026048	4026080	4026081	4026082
	€ U.	42,10	42,30	42,45	43,40	47,80	50,90	62,75	72,25
		ØDe							
		230	250	280	300	350	400	450	500

Ref.	5001471	Unidades de embalaje Packing units Unités d'emballage
€ U.	55,35 <sup>1</sup>	

450	500	550	600
5001477	5001478	5001479	5001480
111,70 <sup>1</sup>	116,40 <sup>1</sup>	121,90 <sup>1</sup>	125,65 <sup>1</sup>
550	600	650	700

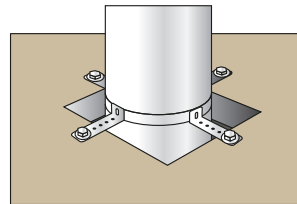
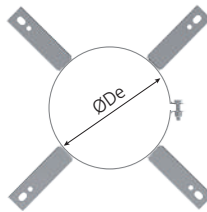

450	500	550	600
4026832	4026833	4026834	4026835
73,05 <sup>1</sup>	81,35 <sup>1</sup>	85,85 <sup>1</sup>	91,15 <sup>1</sup>
173	173	173	173
350	350	350	350
550	600	650	700

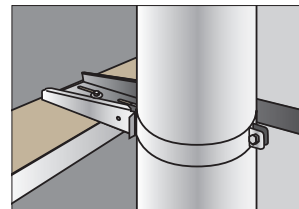
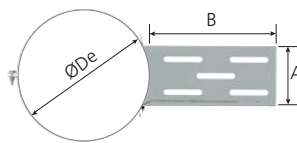

450	500	550	600
4040131	4040132	4040133	4040134
82,30 <sup>1</sup>	86,30 <sup>1</sup>	91,10 <sup>1</sup>	95,85 <sup>1</sup>
550	600	650	700

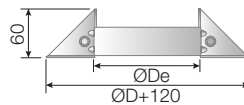

\* Consultar las diferentes opciones de soporte en las páginas 133 y 143.  
For support options, see pages 133 and 143.  
Pour les options de support, voir pages 133 et 143.

5

# 6 TP

Tubería Pellet y Leña  
Pellet and Firewood Piping  
*Tubage Pêle à pellets et Bois  
de Chauffage*

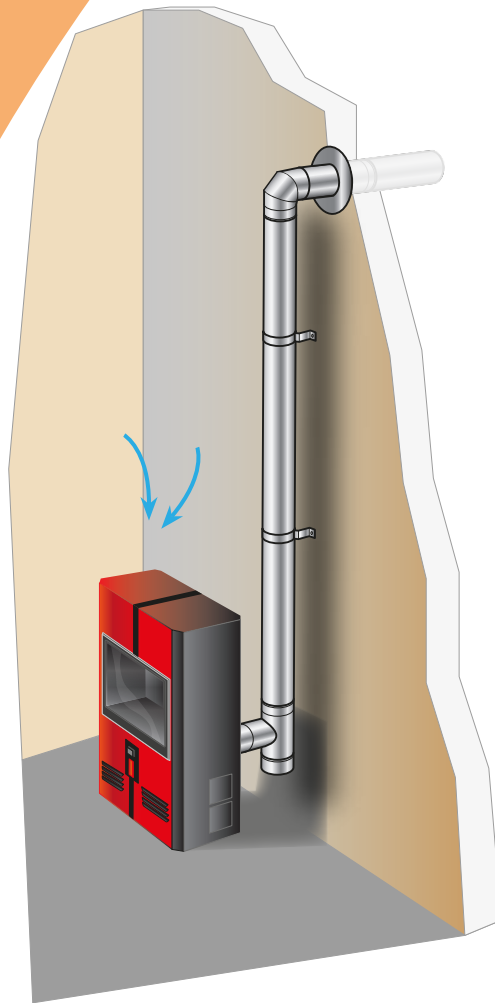

**TP.1** SIMPLE PARED  
SINGLE WALL  
*SIMPLE PAROI*

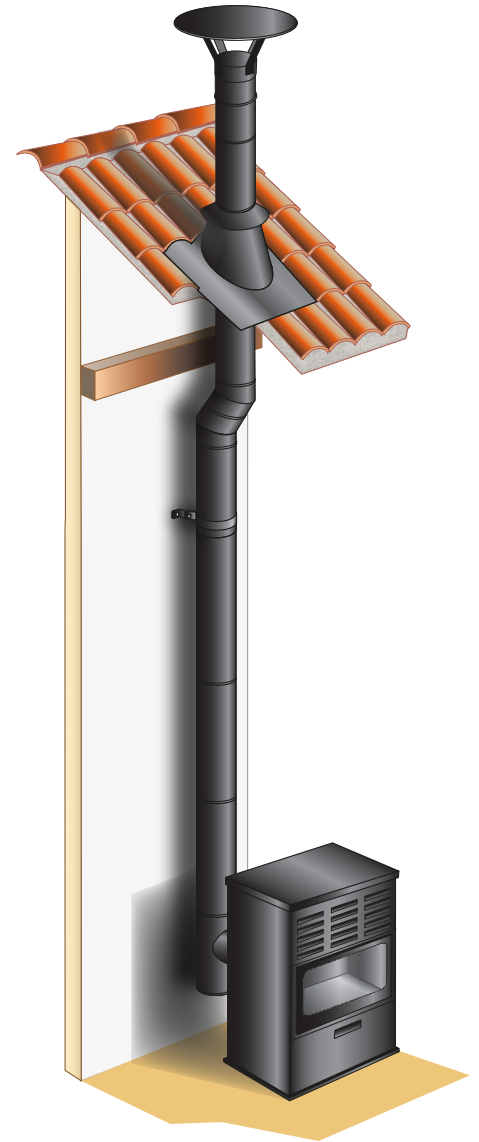

**TP.2** SIMPLE PARED PINTADO NEGRO MATE  
SINGLE WALL, MATT BLACK  
*SIMPLE PAROI NOIR MAT*

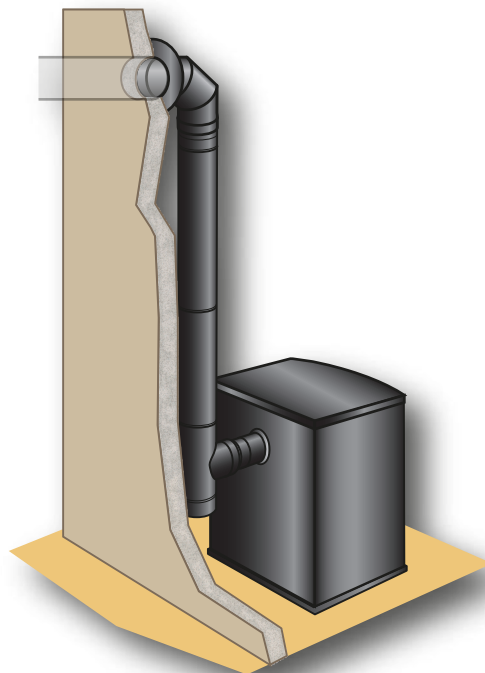

**TP.3** SIMPLE PARED VITRIFICADO  
VITREOUS ENAMEL SINGLE WALL  
*SIMPLE PAROI ÉMAILLÉ*



Espe-  
sor  
Thick-  
ness  
Épais-  
seur

ø80-100 ..... 0,4 mm

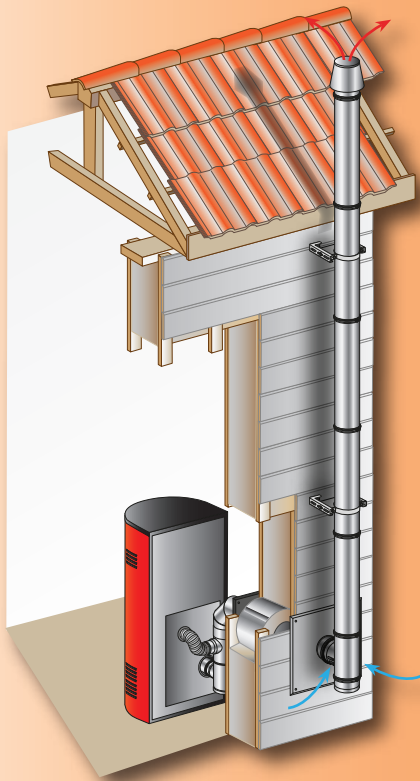

TP.4

DOBLE PARED  
DOUBLE WALL  
DOUBLE PAROI

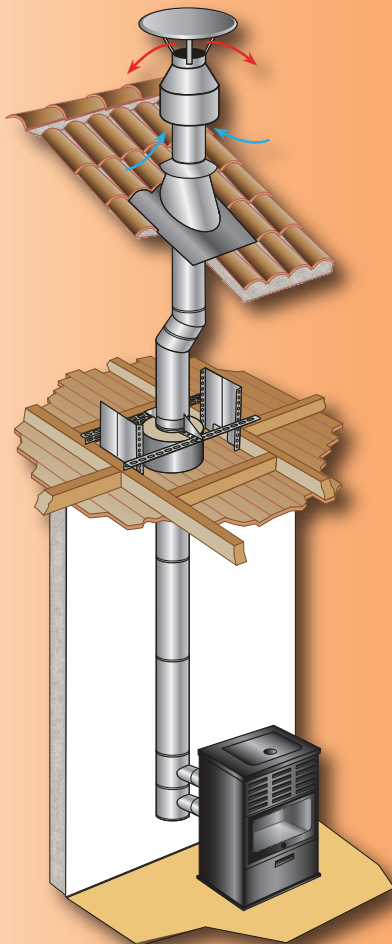

TP.5

CONDUCTO CONCÉNTRICO  
CONCENTRIC PIPING  
CONDUIT CONCENTRIQUE

TP.1



SIMPLE PARED  
SINGLE WALL  
SIMPLE PAROI

AISI 316L

EN 1856-1  
T200 P1 W V2 L50040 O(30)\*

TP.2



SIMPLE PARED NEGRO MATE  
SINGLE WALL, MATT BLACK  
SIMPLE PAROI NOIR MAT

AISI 316L

EN 1856-2  
T200 P1 W V2 L50040 O(75)M\*

TP.3



SIMPLE PARED VITRIFICADO  
VITREOUS ENAMEL SINGLE WALL  
SIMPLE PAROI ÉMAILLÉ

VITRI-M DC01EK AM O

EN 1856-2  
T200 P1 W Vm L80050 O(30) M

TP.4



DOBLE PARED  
DOUBLE WALL  
DOUBLE PAROI

AISI 316L-304

EN 1856-1  
T200 P1 W V2 L50040 O(15)\*

TP.5

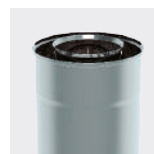

CONDUCTO CONCÉNTRICO  
CONCENTRIC PIPING  
CONDUIT CONCENTRIQUE

AISI 316L-304

EN 14989-2  
T200 P1 W V2 L50040 O(20)\*

Módulo lineal  
Linear module  
Élément droit

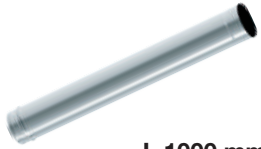

L 1000 mm

ØD	80	100
Ref.	4600000	4600001
€ U.	40,05 6	45,95 6

Módulo lineal  
Linear module  
Élément droit



L 500 mm

ØD	80	100
Ref.	4600020	4600021
€ U.	25,85 4	29,35 4

Módulo lineal  
Linear module  
Élément droit



L 250 mm

ØD	80	100
Ref.	4600030	4016229
€ U.	17,40 4	20,45 4

Módulo extensible  
Extendable module  
Élément télescopique



L min 500 - L max 900

ØD	80	100
Ref.	4600070	4600071
€ U.	56,65 2	61,25 2

Módulo extensible  
Extendable module  
Élément télescopique



L min 335 - L max 565

ØD	80	100
Ref.	4010847	4016643
€ U.	44,00 2	49,80 2

Módulo extensible  
Extendable module  
Élément télescopique



L min 200 - L max 300

ØD	80	100
Ref.	4600060	4600061
€ U.	39,15 2	42,60 2

Codo  
Elbow  
Coude



15°

ØD	80	100
Ref.	4019654	4019656
€ U.	38,20 4	39,10 4

Codo  
Elbow  
Coude



30°

ØD	80	100
Ref.	4015623	4019645
€ U.	23,75 4	27,30 4

Codo  
Elbow  
Coude



45°

ØD	80	100
Ref.	4600080	4600081
€ U.	23,75 4	27,30 4

Codo  
Elbow  
Coude



87°

ØD	80	100
Ref.	4600090	4600091
€ U.	34,90 4	38,70 4

Adaptador Macho-Macho  
Male-Male Adapter  
Adaptateur Mâle-Mâle



ØD 80 100

Ref.	4010845	4016603
€ U.	16,20 4	19,05 4

Adaptador Hembra-Hembra  
Female-Female Adapter  
Adaptateur Femelle-Femelle



ØD 80 100

Ref.	4009592	4015046
€ U.	16,65 4	19,95 4

Te  
"T" Piece  
Té



90°

ØD	80	100
Ref.	4022035	4022036
€ U.	45,00 3	52,85 3

Te  
"T" Piece  
Té



93°

ØD	80	100
Ref.	4022073	4022074
€ U.	45,00 3	52,85 3

Te  
"T" Piece  
Té



135°

ØD	80	100
Ref.	4022250	4022251
€ U.	69,70 2	73,70 2

Te base con tapa  
Base "T" Piece with cap  
Té départ avec tampon



ØD 80 100

Ref.	4021627	4011365
€ U.	73,85 2	82,65 2

Módulo de inspección  
Inspection module  
Module d'inspection



ØD 80 100

Ref.	4020116	4020117
€ U.	62,05 1	70,50 1

Codo de inspección  
Inspection elbow  
Coude d'inspection



87°

ØD	80	100
Ref.	4024385	4024387
€ U.	99,35 1	110,05 1

Tapa de inspección  
Inspection cover  
Trappe d'inspection



200°C / 200 Pa

ØD	80	100
Ref.	5003265	5003266
€ U.	25,75 1	26,20 1

Tapa  
Cap  
Tampon



ØD	80	100
Ref.	4010844	4015924
€ U.	28,95 4	29,95 4

Tapa purga  
Condensate cap  
Tampon récupérateur condensats



ØD 80 100

Ref.	4015544	4015955
€ U.	31,10 4	32,25 4

Tapa purga lateral  
Lateral condensate cap  
Tampon récupérateur condensats laterale



ØD 80 100

Ref.	4019678	4019680
€ U.	43,80 1	45,25 1

Sombrero antilluvia  
Rain cap  
Chapeau pare-pluie



ØD 80 100

Ref.	4600330	4600331
€ U.	56,20 1	59,50 1

Sombrero antiretorno  
Non-return cap  
Chapeau anti-refoulement



ØD 80 100

Ref.	4600320	4600321
€ U.	88,40 1	97,65 1

Sombrero salida libre  
Outlet cone  
Cône de finition



ØD 80 100

Ref.	4600340	4600341
€ U.	58,65 1	64,90 1

Ref.	4600000	Unidades de embalaje Packing units Unités d'emballage
€ U.	40,05 <b>6</b>	



Abrazadera de unión incluida en todas las piezas.  
Connection bracket included in all parts.  
Collier de fixation inclus dans toutes les pièces.



Junta incluida.  
Gasket included.  
Joint inclus.

Sombrero pico-flauta  
Flute peak cap  
Chapeau de flûte



ØD	80	100
Ref.	4007540	4007541
€ U.	61,05 1	64,10 1

Sombrero salida horizontal  
Horizontal outlet cap  
Chapeau sortie horizontale



500 mm		
ØD	80	100
Ref.	4600350	4016484
€ U.	46,80 1	48,55 1

Collarín  
Storm collar  
Collerette



75 mm		
ØD	80	100
Ref.	4019980	4019981
€ U.	30,10 1	30,30 1

Rosetón  
Rosette  
Rosace



ØD	80	100
Ref.	4007378	2700643
€ U.	26,85 1	28,40 1

Embellecedor techo horizontal 1 pieza  
Horizontal sloping roof trim 1 unit  
Plaque de finition 1 pièce



ØD	80	100
Ref.	4014804	4015186
€ U.	24,80 1	25,50 1

Junta silicona  
Silicone gasket  
Joint silicone



ØD	80	100
Ref.	5003948	5003950
€ U.	1,50 10	1,65 10

Rosetón EPDM  
Rosette EPDM  
Rosace EPDM



ØD	80	100
Ref.	5005897	5005899
€ U.	5,95 1	7,45 1

Abrazadera mural interior  
Interior wall bracket  
Collier support mural intérieur



ØD	80	100
Ref.	2500046	2500037
€ U.	10,30 6	11,80 6

Abrazadera atornillada  
Screwed bracket  
Collier à vis



ØD	80	100
Ref.	2500026	2500023
€ U.	8,65 1	8,90 1

Cubreaguas inoxidable horizontal  
Horizontal stainless steel roof flashing  
Solin inoxydable horizontal



ØD	80	100
Ref.	2700944	2700939
€ U.	98,80 1	103,00 1

Cubreaguas inoxidable  
Stainless steel roof flashing  
Solin inoxydable



5°-25°		
ØD	80	100
Ref.	4026713	4026715
€ U.	192,90 1	196,25 1

Cubreaguas inoxidable  
Stainless steel roof flashing  
Solin inoxydable



25°-45°		
ØD	80	100
Ref.	4026730	4026731
€ U.	194,75 1	200,60 1

Cubreaguas inoxidable  
Stainless steel roof flashing  
Solin inoxydable



45°-60°		
ØD	80	100
Ref.	4026745	4026746
€ U.	214,25 1	219,65 1

Aumento  
Augmentation adapter  
Augmentation



ØD	80-100
Ref.	4600404
€ U.	54,85 1

Reducción  
Reduction adapter  
Réduction



ØD	80-100
Ref.	4022589
€ U.	58,95 1

Carrete recortable  
Trimtable module  
Élément découppable



L 250 mm		
ØD	80	100
Ref.	4040045	4040046
€ U.	26,10 1	30,70 1

## Kit instalación estufas pellet | Installation kit pellet stoves | Kit installation poêles à granulés



EN 1856-2 T200 P1 W V2 L50040 O (30)



Diámetro / Diameter / Diamètre	80
Espesor / Sheet thickness / Épaisseur paroi	0,4
Referencia / Reference / Référence	5007180
Precio / Price / Prix €	<b>263,65</b>

Consta de:

- 1 Tubo de 1000 mm \*
- 1 Tubo de 500 mm \*
- 1 Codo 87° \*
- 1 Te base 90° con tapa \*
- 1 Rosetón
- \* Juntas de silicona incluidas

Contains:

- 1 Pipe 1000 mm \*
- 1 Pipe 500 mm \*
- 1 Elbow 87° \*
- 1 Base "T" piece 90° with Cover \*
- 1 Rosette
- \* Silicone Gaskets are included

Composé de :

- 1 Conduit 1000 mm \*
- 1 Conduit 500 mm \*
- 1 Coude 87° \*
- 1 Té départ 90° avec tampon \*
- 1 Rosace
- \* Joints en silicone sont inclus

### Módulo lineal | Pipe | Élément droit



		ØD mm			
		80	100	125	150
<b>L 1000 mm</b>					
AISI 316L	Ref.	4022857	4022858	4024235	4022859
	€ U.	55,65	63,70	71,75	79,90
<b>L 500 mm</b>					
AISI 316L	Ref.	4022860	4022861	4024237	4022862
	€ U.	36,40	41,80	47,05	51,10
<b>L 250 mm</b>					
AISI 316L	Ref.	4022863	4022864	4024236	4022865
	€ U.	27,05	32,75	37,60	40,60

### Codo | Elbow | Coude

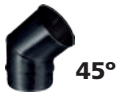

		ØD mm			
		80	100	125	150
AISI 316L	Ref.	4022882	4022883	4024222	4022885
	€ U.	38,60	43,30	50,25	55,10



		ØD mm			
		80	100	125	150
AISI 316L	Ref.	4022886	4022887	4024223	4022888
	€ U.	50,65	56,70	63,05	69,65

### Te base con tapa | "T" Piece with cover | Té base avec tampon



		ØD mm	
		80	100
AISI 316L	Ref.	4024167	4016689
	€ U.	101,60	117,95

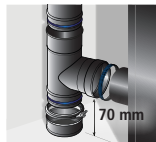

### Adaptador caldera | Boiler adapter | Adaptateur chaudière



		ØD mm			
		80	100	125	150
AISI 316L	Ref.	4022896	4022898	4024215	4022899
	€ U.	39,20	42,60	48,15	51,00

### Adaptador caldera estanco | Sealed boiler adapter | Adaptateur chaudière étanche



		ØD mm	
		80	100
AISI 316L	Ref.	4015206	4016125
	€ U.	39,95	43,85

### Manguito de unión | Connection hose | Manchette de raccordement



250 mm

		ØD mm	
		80	100
AISI 316L	Ref.	4016130	4016131
	€ U.	40,25	44,25

### Analizador gas | Gas analyzer | Analyseur de gaz



		ØD mm			
		80	100	125	150
AISI 316L	Ref.	4027395	4027396	4027405	4027406
	€ U.	71,70	71,95	75,65	81,20

### Módulo extensible | Extendable module | Élément télescopique



		ØD mm			
		80	100	125	150
<b>Lmin 335 mm - Lmax 565 mm</b>					
AISI 316L	Ref.	4022866	4022867	4024228	4022868
	€ U.	64,05	76,05	83,45	89,25

### Te | "T" Piece | Té 93° \*



		ØD mm			
		80	100	125	150
AISI 316L	Ref.	4022869	4022870	4024234	4022871
	€ U.	60,05	71,05	78,25	90,95

\* No incluye tapa. | Cover not included. | Couvercle non inclus.

### Tapa | Cover | Tampon



		ØD mm				
		80	100	125	150	
<b>A</b>	AISI 316L	Ref.	4022875	4022878	4024232	4022879
	€ U.	41,85	46,95	47,70	49,60	
<b>B</b>	AISI 316L	Ref.	4022872	4022873	4024233	4022874
	€ U.	43,50	48,70	50,15	53,40	

### Adaptador caldera antihollín | Anti-soot boiler adapter | Adaptateur chaudière anti-bistre



		ØD mm			
		80	100	125	150
AISI 316L	Ref.	-	4025417	4025418	4025419
	€ U.	-	48,40	53,90	57,85

### Adaptador hembra-hembra | Double female adapter | Adaptateur femelle-femelle



		ØD mm			
		80	100	125	150
AISI 316L	Ref.	4022901	4022902	4024214	4022904
	€ U.	35,40	40,95	46,60	50,90

### Paso forjado | Ceiling bushing | Traversée d'étage



		ØD mm			
		80	100	125	150
<b>500 mm</b>					
AISI 316L	Ref.	4040258	4040255	4040256	4040257
	€ U.	99,95	118,45	131,70	146,40



Ref.	4022859	Unidades de embalaje Packing units Unités d'emballage
€ U.	79,90 <sup>1</sup>	



Abrazadera de unión incluida en todas las piezas.  
Connection bracket included in all parts.  
Collier de fixation inclus dans tous les pièces.



Junta incluida.  
Gasket included.  
Joint inclus.

### Sombrero antiretorno | Non-return cap | *Chapeau anti-refoulement*



		ØD mm			
		80	100	125	150
AISI 316L	Ref.	4022889	4022890	4024231	4022892
	€ U.	108,05 <sup>1</sup>	120,40 <sup>1</sup>	137,25 <sup>1</sup>	157,35 <sup>1</sup>

### Sombrero antilluvia | Rain cap | *Chapeau pare-pluie*



		ØD mm			
		80	100	125	150
AISI 316L	Ref.	4022893	4022894	4024230	4022895
	€ U.	74,35 <sup>1</sup>	80,85 <sup>1</sup>	88,30 <sup>1</sup>	99,15 <sup>1</sup>

### Embellecedor 1 pieza | Trim, 1 piece | *Plaque de finition, 1 pièce*



		ØD mm			
		80	100	125	150
AISI 304	Ref.	4015203	4016147	4024200	4015205
	€ U.	44,65 <sup>1</sup>	45,70 <sup>1</sup>	49,35 <sup>1</sup>	57,45 <sup>1</sup>

### Embellecedor 2 piezas | Trim, 2 pieces | *Plaque de finition, 2 pièces*

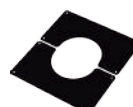

		ØD mm			
		80	100	125	150
AISI 304	Ref.	4023250	4023394	4024207	4023395
	€ U.	49,45 <sup>1</sup>	51,65 <sup>1</sup>	57,45 <sup>1</sup>	67,50 <sup>1</sup>

### Rosetón | Rosette | *Rosace*



		ØD mm			
		80	100	125	150
AISI 304	Ref.	4016074	4016077	4024213	4016148
	€ U.	39,90 <sup>1</sup>	43,80 <sup>1</sup>	52,35 <sup>1</sup>	58,70 <sup>1</sup>

### Collarín | Storm collar | *Collerette*



		ØD mm			
		80	100	125	150
AISI 304	Ref.	4014679	4016124	4024195	4014753
	€ U.	44,60 <sup>1</sup>	51,15 <sup>1</sup>	56,80 <sup>1</sup>	60,80 <sup>1</sup>

### Abrazadera mural interior | Interior wall band | *Collier support mural intérieur*



		ØD mm			
		80	100	125	150
AISI 304	Ref.	4014719	4016109	4024105	4014747
	€ U.	15,75 <sup>1</sup>	18,00 <sup>1</sup>	20,90 <sup>1</sup>	23,20 <sup>1</sup>

### Abrazadera unión tornillo | Locking band | *Collier verrouillage*



		ØD mm			
		80	100	125	150
AISI 304	Ref.	4022253	4022260	4027141	4022263
	€ U.	7,60 <sup>1</sup>	8,05 <sup>1</sup>	8,80 <sup>1</sup>	9,55 <sup>1</sup>

### Abrazadera atornillada | Screwed bracket | *Collier à vis*



		ØD mm	
		80	100
AISI 304	Ref.	4028727	4028728
	€ U.	15,15 <sup>1</sup>	16,50 <sup>1</sup>

### Junta silicona | Silicone gasket | *Joint silicone*



		Ø mm			
		80	100	125	150
Ref.		5003948	5003950	5003951	5003952
	€ U.	1,50 <sup>10</sup>	1,65 <sup>10</sup>	1,95 <sup>10</sup>	2,60 <sup>10</sup>

### Aumento | Augmentation adapter | *Augmentation*



		Ø			
		80	100	125	150
AISI 316L	Ref.	4022920			
	€	71,25			
	Ref.	4022921	4022923	4024217	
	€	76,15	82,65	82,45	
	Ref.	4022922	4022924	4024218	
€	81,20	90,85	84,15		
Ref.				4022925	
€				126,05	
Ref.				4022926	
€				130,15	

		L mm			
		80	100	125	150
ØDs mm	ØDi mm	80	100	125	150
	100	141			
	130	197	159	110	
	150	234	197	150	
	180				155
200				193	

### Cubreaguas plomo | Lead roof flashing | *Solin plomb* 5° - 25°



+ collarín 75mm  
+ storm collar 75mm  
+ collerette 75mm

		ØD mm			
		80	100	125	150
AISI 304 / Pb	Ref.	4014680	4016122	4024198	4014754
	€ U.	256,70 <sup>1</sup>	269,85 <sup>1</sup>	300,20 <sup>1</sup>	315,05 <sup>1</sup>

### Cubreaguas plomo | Lead roof flashing | *Solin plomb* 25° - 45°



+ collarín 75mm  
+ storm collar 75mm  
+ collerette 75mm

		ØD mm			
		80	100	125	150
AISI 304 / Pb	Ref.	4024245	4016123	4024199	4020736
	€ U.	278,20 <sup>1</sup>	291,70 <sup>1</sup>	307,55 <sup>1</sup>	313,80 <sup>1</sup>

### Spray Reparación | Repair spray *Spray réparation* 400 ml NG HT



senotherm®

Ref.	5006097
€ U.	33,90 <sup>1</sup>

### Easy Line Pellet

Ø 80 mm Simple Pared de 0,8 mm de espesor total vitrificado negro mate a 900°C

Ø 80 mm Single Wall with 0,8 mm total thickness matt-black vitrified at 900°C

Ø 80 mm Simple Paroi avec 0,8 mm d'épaisseur total vitrifié noir mat à 900°C

Tubo | Pipe | Conduit

L 1000 mm



ØD	80
Ref.	5701080
€ U.	32,30 6

Tubo | Pipe | Conduit

L 500 mm



ØD	80
Ref.	5702080
€ U.	28,65 12

Tubo | Pipe | Conduit

L 250 mm



ØD	80
Ref.	5703080
€ U.	24,65 4

Módulo extensible | Extendable module | Élément télescopique

L min 335 mm - L max 565



ØD	80
Ref.	5706080
€ U.	53,80 2

Codo | Elbow | Coude

45°



ØD	80
Ref.	5715080
€ U.	38,60 4

Codo | Elbow | Coude

87°



ØD	80
Ref.	5716080
€ U.	41,80 4

Te base con tapa | Base "T" Piece with cover | Té départ avec tampon 90°



ØD	80
Ref.	5721080
€ U.	68,25 2

Manguito | Hose connection | Manchette de raccordement 143 mm



ØD	80
Ref.	5753080
€ U.	28,85 6

Plafón | Rosette | Rosace



ØD	80
Ref.	5361080
€ U.	15,85 1

Ref.	5701080	Unidades de embalaje
€ U.	32,30	Packing units
		Unités d'emballage



Junta incluida.  
Gasket included.  
Joint inclus.

Deflector | Deflector | *Défecteur* AISI 316L



ØD	80
Ref.	5734080
€ U.	63,60 1

Sombrero antiretorno "Cercos" | "Cercos" antireturn cap | *Chapeau anti-refoulement* AISI 316L



ØD	80
Ref.	4022889
€ U.	108,05 1

Abrazadera mural interior | Interior wall bracket | *Collier support mural intérieur* AISI 304



ØD	80
Ref.	4014719
€ U.	15,75 1

Abrazadera atornillada | Screwed bracket | *Collier à vis* AISI 304



ØD	80
Ref.	4028727
€ U.	15,15 1

Junta silicona | Silicone gasket | *Joint silicone* 200°C



ØD	80
Ref.	5003948
€ U.	1,50 10

Junta silicona "hijuela T" | Silicone gasket "branch T" piece | *Joint silicone "annexe Té"* 200°C



ØD	80
Ref.	5003406
€ U.	1,65 1

6

## Kit instalación estufas pellet | Installation kit pellet stoves | *Kit installation poêles à granulés*

EN 1856-2 T200 P1 W Vm L80050 O (30) M



Diámetro / Diameter / <i>Diamètre</i>	80
Espesor total / Total thickness / <i>Épaisseur total</i>	0,8
Referencia / Reference / <i>Référence</i>	5007080
Precio / Price / <i>Prix €</i>	208,45

Consta de:

- 1 Tubo de 1000 mm \*
- 1 Tubo de 500 mm \*
- 1 Codo 87° \*
- 1 Te base 90° con tapa \*
- 1 Rosetón
- \* Juntas de silicona incluidas

Contains:

- 1 Pipe 1000 mm \*
- 1 Pipe 500 mm \*
- 1 Elbow 87° \*
- 1 Base "T" piece 90° with Cover \*
- 1 Rosette
- \* Silicone Gaskets are included

Composé de :

- 1 Conduit 1000 mm \*
- 1 Conduit 500 mm \*
- 1 Coude 87° \*
- 1 Té départ 90° avec tampon \*
- 1 Rosace
- \* Joints en silicone sont inclus

Módulo lineal  
Linear module  
Élément droit

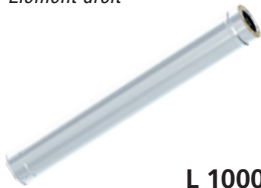

L 1000

ØDi	80	100
Ref.	4600500	4600501
€ U.	99,75 1	109,90 1

Módulo lineal  
Linear module  
Élément droit



L 500

ØDi	80	100
Ref.	4600510	4600511
€ U.	56,90 1	67,50 1

Módulo lineal  
Linear module  
Élément droit



L 250

ØDi	80	100
Ref.	4013602	4016260
€ U.	43,50 1	47,75 1

Módulo extensible  
Extendable module  
Élément télescopique



L min 500 - L max 900

ØDi	80	100
Ref.	4600560	4600561
€ U.	161,85 1	175,45 1

Módulo extensible  
Extendable module  
Élément télescopique



L min 335 - L max 565

ØDi	80	100
Ref.	4700650	4700651
€ U.	115,60 1	127,15 1

Módulo extensible  
Extendable module  
Élément télescopique



L min 200 - L max 300

ØDi	80	100
Ref.	4700660	4016659
€ U.	75,35 1	91,30 1

Codo  
Elbow  
Coude



15°

ØDi	80	100
Ref.	4016570	4016571
€ U.	67,95 1	71,80 1

Codo  
Elbow  
Coude



30°

ØDi	80	100
Ref.	4015622	4016580
€ U.	67,95 1	71,80 1

Codo  
Elbow  
Coude



45°

ØDi	80	100
Ref.	4600530	4600531
€ U.	71,90 1	74,65 1

Codo  
Elbow  
Coude



87°

ØDi	80	100
Ref.	4600520	4600521
€ U.	123,75 1	133,25 1

Adaptador DP-SP  
DW-SW adapter  
Adaptateur DP-SP



ØDi	80	100
Ref.	4015108	4016622
€ U.	47,30 1	53,30 1

Te  
"T" Piece  
Té



90°

ØDi	80	100
Ref.	4019993	4019994
€ U.	112,55 1	126,35 1

Te  
"T" Piece  
Té



135°

ØDi	80	100
Ref.	4021783	4021786
€ U.	172,85 1	223,10 1

Te base con tapa  
"T" Piece with cover  
Te base avec tampon



ØDi	80	100
Ref.	4031146	4031147
€ U.	145,20 1	161,85 1

Te con admisión aire  
"T" Piece with admission  
Té avec admission d'air



ØDi	80-80/125	100-100/150
Ref.	4022136	4022137
€ U.	140,60 1	168,65 1

Adaptador biflujo  
Biflow adapter  
Adaptateur bifluje



ØDi	80/125	100/150
Ref.	4040020	4040022
€ U.	182,65 1	214,15 1

Codo inspección  
Inspection cover  
Trappe d'inspection



87°

ØDi	80	100
Ref.	4019914	4019915
€ U.	282,45 1	304,70 1

Módulo de inspección  
Inspection module  
Module d'inspection



ØDi	80	100
Ref.	4020059	4020060
€ U.	146,15 1	152,25 1

Tapa de inspección  
Inspection cover  
Trappe d'inspection



200°C / 200 Pa

ØDi	80	100
Ref.	5003265	5003266
€ U.	25,75 1	26,20 1

Tapa  
Cap  
Tampon



ØDi	80	100
Ref.	4015925	4015931
€ U.	37,60 1	38,80 1

Tapa purga  
Condensate cap  
Tampon récupérateur condensats



ØDi	80	100
Ref.	4015936	4015575
€ U.	40,50 1	42,10 1

Soporte mural intermedio  
Intermediate wall support  
Support mural base



ØDi	80	100
Ref.	4020107	4020108
€ U.	117,65 1	123,05 1

Sombrero antiretorno  
Non-return cap  
Chapeau anti-refoulement



ØDi	80	100
Ref.	4600592	4600593
€ U.	93,55 1	113,80 1

Sombrero antilluvia  
Rain cap  
Chapeau pare-pluie



ØDi	80	100
Ref.	4700595	4700596
€ U.	67,00 1	72,85 1

Sombrero salida libre  
Exhaust high cone  
Cône de finition haute



ØD	80	100
Ref.	4600590	4600591
€ U.	60,55 1	66,75 1

Ref.	4600500	Unidades de embalaje Packing units Unités d'emballage
€ U.	99,75	1

 **Abrazadera de unión incluida en todas las piezas.**  
Connection bracket included in all parts.  
*Collier de fixation inclus dans tous les pièces.*

 **Junta incluida.**  
Gasket included.  
*Joint inclus.*

**Sombrero terminal sencillo**  
Simple cap  
*Cône de finition*



ØD	80	100
Ref.	4016487	4016488
€ U.	53,95 1	59,45 1

**Sombrero pico flauta**  
Flute peak cap  
*Chapeau de flûte*



ØD	80	100
Ref.	4014044	4009839
€ U.	87,45 1	97,80 1

**Sombrero salida vertical**  
Vertical outlet cap  
*Chapeau sortie verticale*



ØD	80	100
Ref.	4014655	4014656
€ U.	160,35 1	178,00 1

**Junta silicona**  
Silicone gasket  
*Joint silicone*



ØD	80	100
Ref.	5003948	5003950
€ U.	1,50 10	1,65 10

**Abrazadera atornillada**  
Screwed bracket  
*Collier à vis*



ØD	80	100
Ref.	2500024	2500025
€ U.	9,55 1	9,80 1

**Abrazadera forjado reforzada**  
Reinforced ceiling bracket  
*Collier support plancher renforcé*



ØD	80	100
Ref.	4026828	9023220
€ U.	50,95 1	51,30 1

**Abrazadera mural interior**  
Interior wall bracket  
*Collier support mural intérieur*



ØD	80	100
Ref.	2500038	2500039
€ U.	13,90 6	14,75 6

**Abrazadera pared regulable**  
Adjustable wall bracket  
*Collier mural réglable*



ØD	80	100
Ref.	4600707	4600703
€ U.	17,05 1	19,30 1

**Soporte pared regulable**  
Adjustable wall support  
*Support mural réglable*



ØD	80	100
Ref.	4600725	4600721
€ U.	98,35 1	102,70 1

**Rosetón**  
Rosette  
*Rosace*



ØD	80	100
Ref.	2700632	2700633
€ U.	34,15 1	35,60 1

**Embellecedor techo horizontal** 1 pieza  
Horizontal sloping roof trim 1 unit  
*Plaque de finition 1 pièce*



ØD	80	100
Ref.	4014805	4014806
€ U.	28,50 1	33,15 1

**Collarín**  
Storm collar  
*Collerette*



**75mm**

ØD	80	100
Ref.	4019983	4014984
€ U.	32,35 1	35,40 1

**Cubreaguas inoxidable horizontal**  
Horizontal stainless steel roof flashing  
*Solin inoxydable horizontal*



ØDi	80	100
Ref.	2700940	2700868
€ U.	119,45 1	129,70 1

**Cubreaguas inoxidable**  
Stainless steel roof flashing  
*Solin inoxydable*



ØDi	80	100
Ref.	4026718	4026720
€ U.	202,15 1	203,10 1

**Cubreaguas inoxidable**  
Stainless steel roof flashing  
*Solin inoxydable*



ØD	80	100
Ref.	4026734	4026736
€ U.	204,25 1	205,15 1

**Cubreaguas inoxidable**  
Stainless steel roof flashing  
*Solin inoxydable*



ØD	80	100
Ref.	4026751	4026753
€ U.	224,55 1	225,70 1

**Aumento**  
Augmentation adapter  
*Augmentation*



ØD	80-100
Ref.	4022652
€ U.	170,95 1

**Reducción**  
Reduction adapter  
*Réduction*



ØD	80-100
Ref.	4022715
€ U.	173,90 1

Ø80-100

Material: | Material: | Matériel : AISI 316L-304

Módulo lineal  
Linear module  
Élément droit

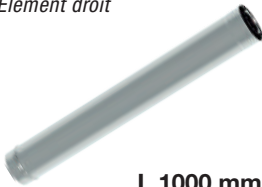

L 1000 mm

ØD	80/125	100/150
Ref.	4025846	4014581
€ U.	108,70	114,40

Módulo lineal  
Linear module  
Élément droit



L 500 mm

ØD	80/125	100/150
Ref.	4025845	4014593
€ U.	90,25	94,45

Módulo lineal  
Linear module  
Élément droit



L 250 mm

ØD	80/125	100/150
Ref.	4025844	4016739
€ U.	74,70	76,75

Módulo extensible  
Extendable module  
Élément télescopique



L min 500 - L max 900

ØD	80/125	100/150
Ref.	4025850	9023076
€ U.	154,85	168,25

Módulo extensible  
Extendable module  
Élément télescopique



L min 335 - L max 565

ØD	80/125	100/150
Ref.	4025849	4014592
€ U.	141,00	145,70

Codo  
Elbow  
Coude



45°

ØD	80/125	100/150
Ref.	4027144	4014583
€ U.	75,80	82,30

Codo  
Elbow  
Coude



87°

ØD	80/125	100/150
Ref.	4025847	4014584
€ U.	121,40	131,55

Te  
"T" Piece  
Té



93°

ØD	80/125	100/150
Ref.	4028307	4028447
€ U.	108,20	126,10

Te reducida con admisión aire  
"T" Piece reduced with admission  
Té réduit avec admission d'air



90°

ØD	80/125	100/150
Ref.	4028308	4020569
€ U.	135,40	159,70

Te salida gas con tapa purga  
"T" piece gas outlet with condensate cap  
Té sortie gaz avec tampon récupérateur condensats



93°

ØD	80/125	100/150
Ref.	4028309	9023068
€ U.	255,70	300,85

Módulo de inspección  
Inspection module  
Module d'inspection



ØD	80/125	100/150
Ref.	4028311	4023073
€ U.	108,20	115,55

Te giratoria H/H corta  
Rotary "T" Piece F/F short  
Té rotatif F/F court



ØD	80/125	100/150
Ref.	4029297	4029296
€ U.	357,40	287,20

Te giratoria M/H corta  
Rotary "T" Piece M/F short  
Té rotatif M/F court



ØD	80/125	100/150
Ref.	4029302	4029293
€ U.	346,90	364,35

Te giratoria M/H larga  
Rotary "T" Piece M/F long  
Té giratoire M/F longue



ØD	80/125	100/150
Ref.	4029301	4029299
€ U.	376,40	153,57

Te giratoria M/H reducida a 60 mm  
Rotary "T" Piece M/F reduced to 60 mm  
Té giratoire M/F réduit à 60 mm



ØD	80/125	100/150
Ref.	9023071	9023070
€ U.	411,05	431,80

Adaptador biflujó  
Two-way flow adapter  
Adaptateur biflujó



ØD	80/125	100/150
Ref.	4040020	4040022
€ U.	182,65	214,15

Tapa de inspección  
Inspection cover  
Trappe d'inspection



200°C / 200 Pa

ØDint	80/125	100/150
Ref.	5003265	5003266
€ U.	25,75	26,20

Tapa  
Cap  
Tampon



ØD	80/125	100/150
Ref.	4028312	4020664
€ U.	80,15	84,00

Tapa purga  
Condensate cap  
Tampon récupérateur condensats



ØD	80/125	100/150
Ref.	4028313	4020465
€ U.	98,40	105,40

Soporte mural intermedio  
Intermediate wall support  
Support mural base



ØD	80/125	100/150
Ref.	4028316	4023079
€ U.	88,30	92,35

Ref.	4025846	Unidades de embalaje Packing units Unités d'emballage
€ U.	108,70 1	

 **Abrazadera de unión incluida en todas las piezas.**  
Connection bracket included in all parts.  
*Collier de fixation inclus dans tous les pièces.*

 **Junta incluida.**  
Gasket included.  
*Joint inclus.*

**Sombrero salida vertical**  
Vertical exit cap  
*Chapeau sortie verticale*



ØD	80/125	100/150
Ref.	4028314	4014585
€ U.	205,30 1	218,55 1

**Sombrero salida horizontal**  
Horizontal outlet cap  
*Chapeau sortie horizontale*



ØD	80/125	100/150
Ref.	4028315	4016747
€ U.	190,85 1	198,40 1

**Junta silicona**  
Silicone gasket  
*Joint silicone*



ØD	80/125	100/150
Ref.	5003948	5003950
€ U.	1,50 10	1,65 10

**Collarín**  
Storm collar  
*Collerette*



75mm

ØD	80/125	100/150
Ref.	4021061	4019984
€ U.	31,60 1	37,85 1

**Rosetón**  
Rosette  
*Rosace*



ØD	80/125	100/150
Ref.	4013910	2700633
€ U.	33,25 1	35,60 1

**Embellecedor techo horizontal** 1 pieza  
Horizontal sloping roof trim 1 unit  
*Plaque de finition 1 pièce*



ØD	80/125	100/150
Ref.	4022448	4014806
€ U.	27,45 1	33,15 1

**Aumento**  
Augmentation adapter  
*Augmentation*



ØD	100/150 - 80/125
Ref.	4027828
€ U.	107,90 1

**Reducción**  
Reduction adapter  
*Réduction*



ØD	80/125 - 100/150
Ref.	4019103
€ U.	107,90 1

**Abrazadera mural interior**  
Interior wall bracket  
*Collier support mural intérieur*



ØD	80/125	100/150
Ref.	4013902	2500039
€ U.	13,50 6	14,75 6

**Abrazadera mural interior regulable**  
Interior adjustable wall bracket  
*Bride murale intérieur réglable*



ØD	80/125	100/150
Ref.	4600702	4600703
€ U.	16,45 1	19,30 1

**Abrazadera atornillada**  
Screwed bracket  
*Collier à vis*



ØD	80/125	100/150
Ref.	4013908	2500025
€ U.	9,50 1	9,80 1

**Abrazadera forjado reforzada**  
Reinforced ceiling bracket  
*Collier support plancher renforcé*



ØD	80/125	100/150
Ref.	4028374	9023220
€ U.	50,95 1	51,30 1

**Cubreaguas inoxidable horizontal**  
Horizontal stainless steel roof flashing  
*Solin inoxydable horizontal*

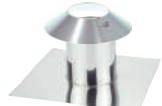

+ collarín 75mm  
+ storm collar 75mm  
+ collerette 75mm

ØD	80/125	100/150
Ref.	4013886	2700868
€ U.	116,75 1	129,70 1

**Cubreaguas inoxidable**  
Stainless steel roof flashing  
*Solin inoxydable*



5°-25°

+ collarín 75mm  
+ storm collar 75mm  
+ collerette 75mm

ØD	80/125	100/150
Ref.	4026717	4026720
€ U.	201,40 1	203,10 1

**Cubreaguas inoxidable**  
Stainless steel roof flashing  
*Solin inoxydable*



25°-45°

+ collarín 75mm  
+ storm collar 75mm  
+ collerette 75mm

ØD	80/125	100/150
Ref.	4026733	4026736
€ U.	203,45 1	205,15 1

**Cubreaguas inoxidable**  
Stainless steel roof flashing  
*Solin inoxydable*



45°-60°

+ collarín 75mm  
+ storm collar 75mm  
+ collerette 75mm

ØD	80/125	100/150
Ref.	4026749	4026753
€ U.	223,80 1	225,70 1

**Tubo flexible admisión de aire**  
Flexible air intake tube  
*Tube flexible admission d'air*



+ racord de conexión EPDM  
+ EPDM connection racord  
+ raccord de connexion EPDM

ØD	60-40
Ref.	4049060
€ U.	68,45 1

**Te 90° admisión base reducida**  
"T" Piece reduced with air admission  
*Té réduit avec admission d'air*



+ protección Te Base  
+ "T" Piece protection  
+ protection Té

Ø60

ØD	80/125
Ref.	4049125
€ U.	157,60 1

**Te base con tapa**  
Base "T" Piece with cap  
*Té départ avec tampon*



ØD 80

Ref.	4021627
€ U.	73,85 2

**Placa biflujo**  
Biflow plate  
*Plaque bi-flux*



ØD 80 100

Ref.	4040027	4040028
€ U.	75,75 1	75,75 1

Adaptador CC - SP con placa  
CC - SW Adapter with plate  
Adaptateur CC - SP avec plaque



ØD	80/125	100/150
Ref.	4040041	4040042
€ U.	102,40 1	109,55 1

Adaptador SP - CC con placa  
SW - CC Adapter with plate  
Adaptateur SP - CC avec plaque



ØD	80/125	100/150
Ref.	4040043	4040044
€ U.	107,55 1	112,90 1

Kit admisión de aire  
Air intake kit  
Kit admission d'air



ØD	60-40
Ref.	4040029
€ U.	46,90 1

Aislante paso mural G100  
Insulating wall bushing G100  
Coquille isolante G100



**L 330**

ØD	130	150
Ref.	4026230	4026231
€ U.	98,20 1	106,20 1

Aislante paso mural G100  
Insulating wall bushing G100  
Coquille isolante G100

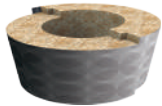

**L 500**

ØD	130	150
Ref.	4026232	4026233
€ U.	127,95 1	137,05 1

Aislante paso mural G100  
Insulating wall bushing G100  
Coquille isolante G100

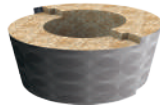

**L 660**

ØD	130	150
Ref.	4026234	4026235
€ U.	165,35 1	177,85 1

Distanciador fuego ventilado G100  
Ventilated firebreak G100  
Plaque écart au feu ventilée G100



ØD	125	150
Ref.	4025690	4025691
€ U.	88,90 1	89,30 1

Distanciador fuego estanco horizontal G100  
Horizontal sealed firebreak G100  
Plaque écart au feu étanche horizontale G100



ØD	125	150
Ref.	4025692	4025693
€ U.	192,95 1	197,80 1

Distanciador fuego estanco inclinado G100  
Inclined sealed firebreak G100  
Plaque écart au feu étanche inclinée G100

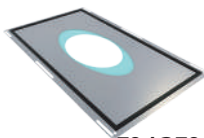

**5° / 25°**

ØD	125	150
Ref.	4025694	4025695
€ U.	200,10 1	205,15 1

Distanciador fuego estanco inclinado G100  
Inclined sealed firebreak G100  
Plaque écart au feu étanche inclinée G100

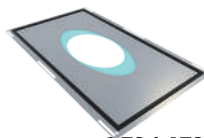

**25° / 45°**

ØD	125	150
Ref.	4025696	4025697
€ U.	230,10 1	235,95 1

Distanciador fuego estanco inclinado G100  
Inclined sealed firebreak G100  
Plaque écart au feu étanche inclinée G100

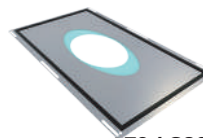

**45° / 60°**

ØD	125	150
Ref.	4025698	4025699
€ U.	253,10 1	259,45 1

Rejilla de ventilación  
Ventilation grille  
Grille de ventilation



**150 mm x 300 mm**

Ref.	6183300
€ U.	42,20 1

Rejilla de ventilación  
Ventilation grille  
Grille de ventilation



**200 mm x 200 mm**

Ref.	6183200
€ U.	34,40 1



Ref.	4025846	Unidades de embalaje Packing units Unités d'emballage
€ U.	108,70	1



Abrazadera de unión incluida en todas las piezas.  
Connection bracket included in all parts.  
*Collier de fixation inclus dans tous les pièces.*



Junta incluida.  
Gasket included.  
*Joint inclus.*

## Kit instalación estufas pellet | Installation kit pellet stoves | *Kit installation poêles à granulés*

### 80/130

Inoxidable brillante  
Bright stainless  
*Brillant inoxydable*



Referencia / Reference / Référence	4048130
Precio / Price / Prix €	354,40

Inoxidable negro mate  
Matt black stainless  
*Inoxydable noir mat*



Referencia / Reference / Référence	4047130
Precio / Price / Prix €	415,65

#### Consta de:

- 1 Tubo de 1000 mm
- 1 Tubo de 500 mm
- 1 Codo 87°
- 1 Rosetón
- 1 Sombrero salida horizontal
- 1 Te 90° admisión base reducida a ø60
- 1 Tubo flexible admisión de aire 1000 mm
- 1 Racord de conexión EPDM
- 1 Módulo de protección
- 1 Te 90° base con tapa condensación
- 1 Manguito liso/Hembra con junta

#### Contains:

- 1 Pipe 1000 mm
- 1 Pipe 500 mm
- 1 Elbow 87°
- 1 Rosette
- 1 Horizontal outlet cap
- 1 "T" Piece reduced with air admission ø60
- 1 Flexible air intake tube 1000 mm
- 1 EPDM connection racord
- 1 "T" Piece protection
- 1 Base "T" Piece with condensation cap
- 1 Smooth hose connection/Female hose connection with gasket

#### Composé de :

- 1 Élément droit 1000 mm
- 1 Élément droit 500 mm
- 1 Coude 87°
- 1 Rosace
- 1 Sortie horizontale
- 1 Té 90° admission d'air base piquage lisse ø60
- 1 Tube flexible admission d'air 1000 mm
- 1 Racord de connexion EPDM
- 1 Module de protection
- 1 Té 90° base avec tampoc condensation
- 1 Raccord lisse/Femelle avec joint

# 7 F

Fumistería  
Connecting flue pipe  
*Fumisterie*

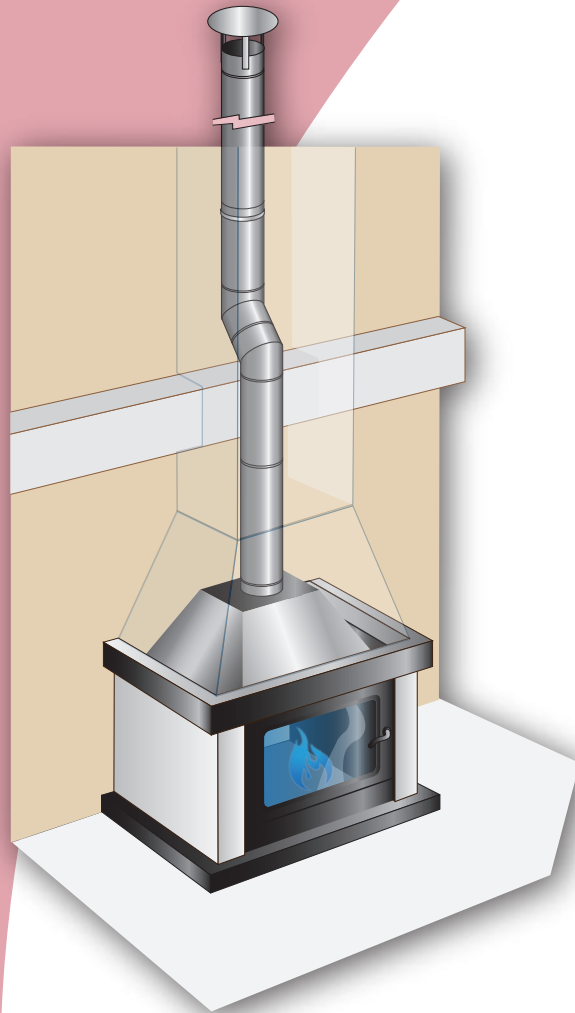

**F.1**

**FUMISTERÍA INOXIDABLE**  
**STAINLESS STEEL CONNECTING FLUE PIPE**  
*FUMISTERIE INOXYDABLE*

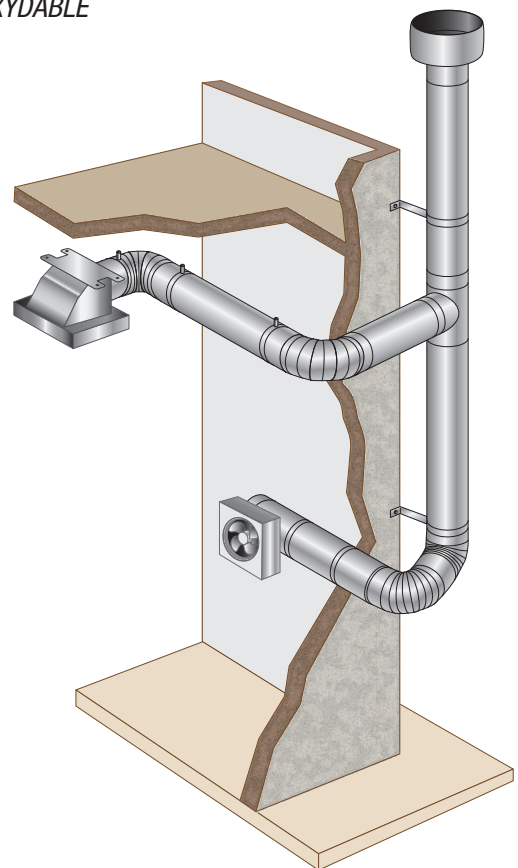

**F.2**

**FUMISTERÍA GALVANIZADA**  
**GALVANIZED CONNECTING FLUE PIPE**  
*FUMISTERIE GALVANISÉE*



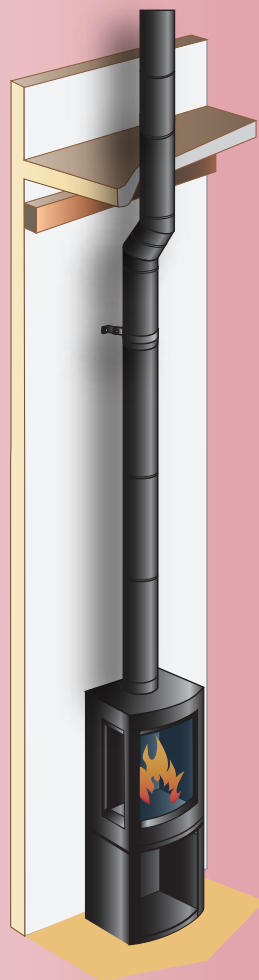

**F.1**

**CE** Especificaciones de acuerdo a la legislación europea en productos de construcción **CPR**  
 Specifications according to EU product regulations of construction **CPR**  
 Spécifications Selon la réglementation européenne concernant les produits de construction **CPR**

**FUMISTERÍA INOXIDABLE**  
**STAINLESS STEEL CONNECTING FLUE PIPE**  
**FUMISTERIE INOXYDABLE**

Espeor Thickness Épaisseur	→	ø80-120 .....	<b>0,4 mm</b>
		ø125-175 .....	<b>0,5 mm</b>
		ø200-400 .....	<b>0,8 mm</b>



**AISI 304L** (1.4307) **2B** mate | matt | mat

**EN 1856-2**

- T600 N1 D Vm L20040 G(600) NM
- T600 N1 D Vm L20050 G(600) NM
- T600 N1 D Vm L20060 G(600) NM
- T600 N1 D Vm L20080 G(600) NM

**F.2**

**FUMISTERÍA GALVANIZADA**  
**GALVANIZED CONNECTING FLUE PIPE**  
**FUMISTERIE GALVANISÉE**

Espeor Thickness Épaisseur	→	ø80-100 .....	<b>0,4 mm</b>
		ø110-150 .....	<b>0,5 mm</b>
		ø120-175 .....	<b>0,8 mm</b>
		ø200-400 .....	<b>1,0 mm</b>

**GALVA** DX51D+Z200-100 MA C

**F.3**

**FUMISTERÍA VITRIFICADA**  
**VITREOUS ENAMEL CONNECTING FLUE PIPE**  
**FUMISTERIE ÉMAILLÉE**

Grosor Thickness Épaisseur	→	ø100-150 .....	<b>1,0 mm</b>
		ø175-200 .....	<b>1,2 mm</b>



**VITRI-B** DC01EK AM O brillante | bright | brillant

**EN 1856-2**

- T600 N2 D Vm L80050 O(600) NM
- T600 N2 D Vm L80080 O(600) NM

Grosor Thickness Épaisseur	→	ø120-200 .....	<b>1,2 mm</b>
----------------------------------	---	----------------	---------------



**VITRI-M** DC01EK AM O mate | matt | mat

**EN 1856-2**

- T600 N2 D Vm L80080 O(600) NM

**F.3**

**FUMISTERÍA VITRIFICADA**  
**VITREOUS ENAMEL CONNECTING FLUE PIPE**  
**FUMISTERIE ÉMAILLÉE**

(brillante | bright | brillant)

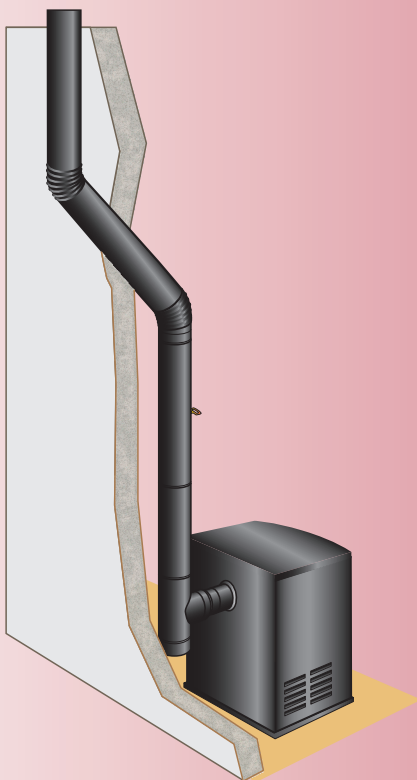

**FUMISTERÍA VITRIFICADA**  
**VITREOUS ENAMEL CONNECTING FLUE PIPE**  
**FUMISTERIE ÉMAILLÉE**



(mate | matt | mat)

Diámetro   diameter   diamètre Ø		80	100	120	125	130	150	175
Espesor   Sheet thickness   Épaisseur paroi		0,4			0,5			
<b>Tubo</b> Pipe <i>Conduit</i> <b>1.000 mm</b> 	Ref.	5301080	5301100	5301120	5301125	5301130	5301150	5301175
	€   U.	17,95   10	20,50   10	21,30   10	21,85   10	22,65   10	24,20   7	29,60   5
<b>Tubo</b> Pipe <i>Conduit</i> <b>500 mm</b> 	Ref.	5302080	5302100	5302120	5302125	5302130	5302150	5302175
	€   U.	11,60   10	13,35   10	13,95   10	14,00   10	14,65   10	15,05   5	18,45   5
<b>Codo rizado estanco</b> Ridged Elbow <i>tight</i> <i>Coude plissé étanche</i> <b>45°</b> 	Ref.	5311080	5311100	5311120	5311125	5311130	5311150	5311175 *
	€   U.	18,05   8	18,50   8	19,05   8	20,50   8	22,45   8	24,80   8	25,80   8
<b>Codo rizado estanco</b> Ridged Elbow <i>tight</i> <i>Coude plissé étanche</i> <b>90°</b> 	Ref.	5313080	5313100	5313120	5313125	5313130	5313150	5313175 *
	€   U.	22,90   4	23,65   4	25,85   4	27,75   4	30,35   4	33,45   4	40,85   4
<b>Te 90° con tapa</b> "T" piece 90° with Cover <i>Té 90° avec tampon</i> 	Ref.			5321120	5321125	5321130	5321150	5321175
	€   U.			68,75   1	70,20   1	72,15   1	74,65   1	86,55   1
<b>Sombrero antilluvia "Seta"</b> "Seta" Rain Cap <i>Chapeau pare-pluie "Seta"</i> 	Ref.	5332080	5332100	5332120	5332125	5332130	5332150	5332175
	€   U.	39,70   1	43,90   1	51,80   1	53,70   1	54,15   1	55,85   1	63,40   1
<b>Sombrero antiretorno "Cerco"</b> "Cerco" Antireturn Cap <i>Chapeau anti-refoulement "Cerco"</i> 	Ref.	5433080	5433100	5433120	5433125	5433130	5433150	5433175
	€   U.	59,75   1	62,20   1	65,20   1	70,60   1	72,50   1	81,10   1	91,90   1
<b>Abrazadera alicatar</b> Wall mounting bracket <i>Collier à vis</i> 	Ref.	5471080	5471100	5471120	5471125	5471130	5471150	5471175
	€   U.	14,00   1	14,10   1	14,20   1	14,25   1	14,80   1	15,75   1	17,00   1
<b>Abrazadera empotrar</b> Bracket with Leg <i>Collier à encastrer</i> 	Ref.	5472080	5472100	5472120	5472125	5472130	5472150	5472175
	€   U.	10,70   1	10,90   1	11,10   1	11,55   1	11,95   1	13,30   1	14,85   1
<b>Manguito Macho-Macho</b> Hose connection Male-Male <i>Manchette de raccordement Mâle-Mâle</i> <b>200 mm</b> 	Ref.		5351100	5351120	5351125	5351130	5351150	5351175
	€   U.		11,95   1	12,55   1	12,60   1	12,95   1	13,50   1	16,50   1
<b>Manguito Hembra-Hembra</b> Hose connection Female-Female <i>Manchette de raccordement Femelle-Femelle</i> <b>200 mm</b> 	Ref.		5352100	5352120	5352125	5352130	5352150	5352175
	€   U.		11,95   1	12,55   1	12,60   1	12,95   1	13,50   1	16,50   1
<b>Reducción   Reduction Adapter I</b> <i>Réduction</i> <b>Ø 125</b> 	Ref.			5441120				
	€   U.			34,90   1				
<b>Reducción   Reduction Adapter I</b> <i>Réduction</i> <b>Ø 130</b>	Ref.			5442120	5442125			
	€   U.			39,95   1	41,10   1			
<b>Reducción   Reduction Adapter I</b> <i>Réduction</i> <b>Ø 150</b>	Ref.			5443120	5443125	5443130		
	€   U.			41,80   1	42,50   1	43,70   1		
<b>Reducción   Reduction Adapter I</b> <i>Réduction</i> <b>Ø 175</b>	Ref.						5444150	
	€   U.						47,20   1	
<b>Reducción   Reduction Adapter I</b> <i>Réduction</i> <b>Ø 200</b>	Ref.						5445150	5445175
	€   U.						51,45   1	53,50   1



















Ref.	5301150	Unidades de embalaje Packing units Unités d'emballage
€   U.	24,20 (17)	

		Diámetro   diameter   diamètre Ø	200	225	250	300	350	400
		Espesor   Sheet thickness   Épaisseur paroi	0,8					
Tubo Pipe Conduit 1.000 mm		Ref.	5401200	5401225	5401250	5401300	5401350	5401400
		€   U.	53,00   4	69,70   4	74,40   3	100,30   3	116,65   1	135,90   1
Tubo Pipe Conduit 500 mm		Ref.	5402200	5402225	5402250	5402300	5402350	5402400
		€   U.	32,25   4	41,85   4	43,20   3	58,20   3	66,60   1	76,15   1
Codo Elbow Coude 45°		Ref.	5415200	5415225	5415250	5415300	5415350	5415400
		€   U.	44,25   8	50,85   8	58,75   8	89,65   8	108,35   8	128,80   8
Codo Elbow Coude 90°		Ref.	5416200	5416225	5416250	5416300	5416350	5416400
		€   U.	62,30   4	74,75   4	85,90   4	126,20   4	150,45   4	177,20   4
Te 90° con tapa "T" piece 90° with Cover Té 90° avec tampon		Ref.	5421200		5421250	5421300		
		€   U.	127,50   1		181,65   1	234,70   1		
Sombrero antilluvia "Seta" "Seta" Rain Cap Chapeau pare-pluie "Seta"		Ref.	5432200	5432225	5432250	5432300	5432350	5432400
		€   U.	80,85   1	109,45   1	124,90   1	159,55   1	219,15   1	246,85   1
Sombrero antiretorno "Cerco" "Cerco" Antireturn Cap Chapeau anti-refoulement "Cerco"		Ref.	5433200	5433225	5433250	5433300	5433350	5433400
		€   U.	111,55   1	145,45   1	161,20   1	218,20   1	335,25   1	420,00   1
Abrazadera alicatar Wall mounting Bracket Collier à vis		Ref.	5471200	5471225	5471250	5471300	5471350	5471400
		€   U.	18,90   1	24,30   1	29,50   1	35,35   1	47,95   1	62,05   1
Abrazadera empotrar Bracket with Leg Collier à encastrer		Ref.	5472200	5472225	5472250	5472300	5472350	5472400
		€   U.	16,95   1	21,55   1	25,50   1	30,20   1	39,85   1	52,60   1
Manguito Macho-Macho Hose connection Male-Male Manchette de raccordement Mâle-Mâle 200 mm		Ref.	5451200					
		€   U.	28,45   1					
Manguito Hembra-Hembra Hose connection Female-Female Manchette de raccordement Femelle-Femelle 200 mm		Ref.	5452200					
		€   U.	28,45   1					
Reducción   Reduction Adapter   Réduction Ø 225		Ref.	5441200					
		€   U.	62,05   1					
Reducción   Reduction Adapter   Réduction Ø 250		Ref.	5442200					
		€   U.	64,60   1					
Reducción   Reduction Adapter   Réduction Ø 300		Ref.			5443250			
		€   U.			78,25   1			
Reducción   Reduction Adapter   Réduction Ø 350		Ref.				5444300		
		€   U.				114,30   1		
Reducción   Reduction Adapter   Réduction Ø 400		Ref.					5445350	
		€   U.					142,05   1	

7

Diámetro   diameter   diamètre Ø		80	100	110	120	125	130	140	150
Espesor   Sheet thickness   Épaisseur paroi		0,4		0,5					
<b>Tubo</b> Pipe <i>Conduit</i> <b>1.000 mm</b> 	<b>Ref.</b>	5101080	5101100	5101110	5101120	5101125	5101130	5101140	5101150
	<b>€   U.</b>	<b>11,30   10</b>	<b>12,55   10</b>	<b>13,10   10</b>	<b>13,60   10</b>	<b>14,15   10</b>	<b>14,65   10</b>	<b>15,95   7</b>	<b>16,45   7</b>
<b>Codo rizado estanco</b> Ridged Elbow <b>tight</b> <i>Coude plissé étanche</i> <b>45°</b> 	<b>Ref.</b>		5111100		5111120	5111125	5111130		5111150
	<b>€   U.</b>		<b>13,40   8</b>		<b>14,85   8</b>	<b>16,80   8</b>	<b>17,95   8</b>		<b>20,10   8</b>
<b>Codo rizado estanco</b> Ridged Elbow <b>tight</b> <i>Coude plissé étanche</i> <b>70°</b> 	<b>Ref.</b>	5112080	5112100	5112110	5112120	5112125	5112130	5112140	5112150
	<b>€   U.</b>	<b>13,10   5</b>	<b>14,40   5</b>	<b>15,25   5</b>	<b>16,15   5</b>	<b>18,25   5</b>	<b>19,35   5</b>	<b>20,60   5</b>	<b>21,85   5</b>
<b>Codo rizado estanco</b> Ridged Elbow <b>tight</b> <i>Coude plissé étanche</i> <b>90°</b> 	<b>Ref.</b>	5113080	5113100	5113110	5113120	5113125	5113130	5113140	5113150
	<b>€   U.</b>	<b>13,10   4</b>	<b>14,40   4</b>	<b>15,25   4</b>	<b>16,15   4</b>	<b>18,25   4</b>	<b>19,35   4</b>	<b>20,60   4</b>	<b>21,85   4</b>
<b>Te 90° con tapa</b> "T" piece 90° with Cover <i>Té 90° avec tampon</i> 	<b>Ref.</b>			5121110	5121120				
	<b>€   U.</b>			<b>36,65   1</b>	<b>37,45   1</b>				
<b>Sombrero antilluvia "Seta"</b> "Seta" Rain Cap <i>Chapeau pare-pluie "Seta"</i> 	<b>Ref.</b>	5132080	5132100	5132110	5132120	5132125	5132130	5132140	5132150
	<b>€   U.</b>	<b>19,45   1</b>	<b>20,00   1</b>	<b>21,05   1</b>	<b>21,65   1</b>	<b>23,25   1</b>	<b>23,45   1</b>	<b>25,60   1</b>	<b>27,30   1</b>
<b>Sombrero antiretorno "Cerco"</b> "Cerco" Antireturn Cap <i>Chapeau anti-refoulement "Cerco"</i> 	<b>Ref.</b>		5233100	5233110	5233120	5233125	5233130	5233140	5233150
	<b>€   U.</b>		<b>52,80   1</b>	<b>54,05   1</b>	<b>55,20   1</b>	<b>59,75   1</b>	<b>61,40   1</b>	<b>63,70   1</b>	<b>68,55   1</b>
<b>Abrazadera alicatar</b> Wall mounting Bracket <i>Collier à vis</i> 	<b>Ref.</b>	5271080	5271100	5271110	5271120	5271125	5271130	5271140	5271150
	<b>€   U.</b>	<b>10,60   1</b>	<b>10,70   1</b>	<b>11,15   1</b>	<b>11,55   1</b>	<b>11,80   1</b>	<b>12,30   1</b>	<b>12,80   1</b>	<b>13,10   1</b>
<b>Abrazadera empotrar</b> Bracket with Leg <i>Collier à encastrer</i> 	<b>Ref.</b>	5272080	5272100	5272110	5272120	5272125	5272130	5272140	5272150
	<b>€   U.</b>	<b>8,10   1</b>	<b>8,15   1</b>	<b>8,35   1</b>	<b>8,55   1</b>	<b>9,05   1</b>	<b>9,65   1</b>	<b>10,20   1</b>	<b>10,85   1</b>
<b>Manguito Macho-Macho</b> Hose connection Male-Male <i>Manchette de raccordement Mâle-Mâle</i> <b>200 mm</b> 	<b>Ref.</b>		5151100	5151110	5151120	5151125	5151130		5151150
	<b>€   U.</b>		<b>10,25   1</b>	<b>10,70   1</b>	<b>10,95   1</b>	<b>11,25   1</b>	<b>11,45   1</b>		<b>11,80   1</b>
<b>Manguito Hembra-Hembra</b> Hose connection Female-Female <i>Manchette de raccordement Femelle-Femelle</i> <b>200 mm</b> 	<b>Ref.</b>		5152100	5152110	5152120	5152125	5152130		5152150
	<b>€   U.</b>		<b>10,25   1</b>	<b>10,70   1</b>	<b>10,95   1</b>	<b>11,25   1</b>	<b>11,45   1</b>		<b>11,80   1</b>
<b>Reducción   Reduction Adapter   Réduction</b> <b>Ø 100</b> 	<b>Ref.</b>	5241080							
	<b>€   U.</b>	<b>18,50   1</b>							
<b>Reducción   Reduction Adapter   Réduction</b> <b>Ø 110</b>	<b>Ref.</b>		5242100						
	<b>€   U.</b>		<b>18,80   1</b>						
<b>Reducción   Reduction Adapter   Réduction</b> <b>Ø 120</b>	<b>Ref.</b>		5243100	5243110					
	<b>€   U.</b>		<b>19,35   1</b>	<b>20,20   1</b>					
<b>Reducción   Reduction Adapter   Réduction</b> <b>Ø 125</b>	<b>Ref.</b>				5244120				
	<b>€   U.</b>				<b>20,85   1</b>				
<b>Reducción   Reduction Adapter   Réduction</b> <b>Ø 130</b>	<b>Ref.</b>				5245120				
	<b>€   U.</b>				<b>21,35   1</b>				
<b>Reducción   Reduction Adapter   Réduction</b> <b>Ø 140</b>	<b>Ref.</b>			5246110	5246120				
	<b>€   U.</b>			<b>21,90   1</b>	<b>22,10   1</b>				
<b>Reducción   Reduction Adapter   Réduction</b> <b>Ø 150</b>	<b>Ref.</b>				5242120				
	<b>€   U.</b>				<b>23,05   1</b>				

Ref.	5101150	Unidades de embalaje Packing units Unités d'emballage
€   U.	16,45 <b>7</b>	

		Diámetro   diameter   diamètre Ø	120	125	130	150	175	200	225	250	300	350	400
		Esesor   Sheet thickness   Épaisseur-paroi	0,8					1,0					
<b>Tubo</b> Pipe <i>Conduit</i> <b>1.000 mm</b> 	Ref.	5201120	5201125	5201130	5201150	5201175	5201200	5201225	5201250	5201300	5201350	5201400	
	€   U.	20,10   10	20,90   5	22,35   5	24,35   5	28,65   5	35,30   4	41,70   4	44,55   3	54,25   3	60,55   1	70,80   1	
<b>Codo</b> Elbow <i>Coude</i> <b>45°</b> 	Ref.	5215120	5215125	5215130	5215150	5215175	5215200	5215225	5215250	5215300	5215350	5215400	
	€   U.	22,90   8	24,35   8	24,80   8	27,50   8	31,25   8	37,80   8	41,15   8	43,75   8	57,65   8	79,20   8	98,45   8	
<b>Codo</b> Elbow <i>Coude</i> <b>90°</b> 	Ref.	5216120	5216125	5216130	5216150	5216175	5216200	5216225	5216250	5216300	5216350	5216400	
	€   U.	28,00   4	29,50   4	30,95   4	34,05   4	40,00   4	49,00   4	53,50   4	56,30   4	83,45   4	107,20   4	136,40   4	
<b>Te 90° con tapa</b> "T" piece 90° with Cover <i>Té 90° avec tampon</i> 	Ref.				5221150	5221175	5221200						
	€   U.				58,35   1	73,80   1	102,50   1						
<b>Sombrero antilluvia "Seta"</b> "Seta" Rain Cap <i>Chapeau pare-pluie "Seta"</i> 	Ref.	5232120	5232125	5232130	5232150	5232175	5232200	5232225	5232250	5232300	5232350	5232400	
	€   U.	43,70   1	45,15   1	45,70   1	47,00   1	53,40   1	67,50   1	90,95   1	102,90   1	131,45   1	179,70   1	202,45   1	
<b>Sombrero antiretorno "Cerco"</b> "Cerco" Antireturn Cap <i>Chapeau anti-refoulement "Cerco"</i> 	Ref.	5233120	5233125	5233130	5233150	5233175	5233200	5233225	5233250	5233300	5233350	5233400	
	€   U.	55,20   1	59,75   1	61,40   1	68,55   1	77,75   1	90,45   1	118,95   1	134,30   1	180,65   1	278,05   1	349,60   1	
<b>Abrazadera alicatar</b> Wall mounting Bracket <i>Collier à vis</i> 	Ref.	5271120	5271125	5271130	5271150	5271175	5271200	5271225	5271250	5271300	5271350	5271400	
	€   U.	11,55   1	11,80   1	12,30   1	13,10   1	13,35   1	16,80   1	18,95   1	21,20   1	24,80   1	32,50   1	47,45   1	
<b>Abrazadera empotrar</b> Bracket with Leg <i>Collier à encastrer</i> 	Ref.	5272120	5272125	5272130	5272150	5272175	5272200	5272225	5272250	5272300	5272350	5272400	
	€   U.	8,55   1	9,05   1	9,65   1	10,85   1	12,10   1	13,95   1	15,40   1	17,35   1	20,40   1	27,05   1	39,95   1	
<b>Manguito Macho-Macho</b> Hose connection Male-Male <i>Manchette de raccordement Mâle-Mâle</i> <b>200 mm</b> 	Ref.	5251120	5251125	5251130	5251150	5251175	5251200		5251250	5251300			
	€   U.	14,15   1	14,70   1	15,75   1	17,15   1	20,05   1	24,75   1		31,60   1	38,00   1			
<b>Manguito Hembra-Hembra</b> Hose connection Female-Female <i>Manchette de raccordement Femelle-Femelle</i> <b>200 mm</b> 	Ref.	5252120	5252125	5252130	5252150	5252175	5252200		5252250	5252300			
	€   U.	14,15   1	14,70   1	15,75   1	17,15   1	20,05   1	24,75   1		31,60   1	38,00   1			
<b>Reducción   Reduction Adapter   Réduction</b> <b>Ø 125</b> 	Ref.	5244120											
	€   U.	20,85   1											
<b>Reducción   Reduction Adapter   Réduction</b> <b>Ø 130</b> 	Ref.	5245120											
	€   U.	21,35   1											
<b>Reducción   Reduction Adapter   Réduction</b> <b>Ø 150</b> 	Ref.	5242120		5242130									
	€   U.	23,05   1		23,50   1									
<b>Reducción   Reduction Adapter   Réduction</b> <b>Ø 175</b> 	Ref.				5243150								
	€   U.				35,15   1								
<b>Reducción   Reduction Adapter   Réduction</b> <b>Ø 200</b> 	Ref.				5244150	5244175							
	€   U.				46,15   1	48,30   1							
<b>Reducción   Reduction Adapter   Réduction</b> <b>Ø 225</b> 	Ref.						5245200						
	€   U.						57,65   1						
<b>Reducción   Reduction Adapter   Réduction</b> <b>Ø 250</b> 	Ref.						5246200						
	€   U.						61,35   1						
<b>Reducción   Reduction Adapter   Réduction</b> <b>Ø 300</b> 	Ref.							5247250					
	€   U.							75,35   1					
<b>Reducción   Reduction Adapter   Réduction</b> <b>Ø 350</b>	Ref.									5248300			
	€   U.									110,95   1			
<b>Reducción   Reduction Adapter   Réduction</b> <b>Ø 400</b>	Ref.										5249350		
	€   U.										137,30   1		

7

### Gama negro brillante | Bright black range | Gamme noir brillant

VITRIFICADO A 90°		90° VITRIFIED		VITRIFIÉ À 90°				
Diámetro / diameter / diamètre Ø		100	110	120	150	175	200	
Espesor total / Total thickness / Épaisseur total		1				1,2		
Tubo Pipe Conduit 1.000 mm		Ref.	5501100	5501110	5501120	5501150	5501175	5501200
		€   U.	21,65   6	22,40   6	23,60   6	27,85   3	41,80   2	47,45   2
Tubo Pipe Conduit 500 mm		Ref.	5502100	5502110	5502120	5502150	5502175	5502200
		€   U.	17,70   12	18,50   12	19,70   12	21,95   6	32,65   4	38,20   4
Tubo con llave Pipe with Tap Conduit clé 1.000 mm		Ref.	5505100	5505110	5505120	5505150	5505175	5505200
		€   U.	35,85   6	36,90   6	38,60   6	45,65   3	67,10   2	75,65   2
Codo rizado Ridged Elbow Coude plissé 45°		Ref.	5511100	5511110	5511120	5511150	5515175 *	5515200 *
		€   U.	14,20   15	14,70   15	15,70   15	20,25   10	31,30   10	40,70   10
Codo rizado Ridged Elbow Coude plissé 70°		Ref.	5512100	5512110	5512120	5512150		
		€   U.	15,4   15	15,95   15	17,05   15	22,25   10		
Codo rizado Ridged Elbow Coude plissé 90°		Ref.	5513100	5513110	5513120	5513150	5516175 *	5516200 *
		€   U.	15,40   12	15,95   12	17,05   12	22,25   8	39,65   8	50,65   8
Te 90° con tapa "T" piece 90° with Cover Té 90° avec tampon		Ref.		5521110	5521120	5521150	5521175	5521200
		€   U.		42,00   10	42,60   10	57,40   6	72,90   4	100,80   4
Plafón (rosetón) Rosette Rosace		Ref.	5561100	5561110	5561120	5561150	5561175	5561200
		€   U.	12,80   1	13,15   1	13,75   1	15,75   1	18,80   1	20,45   1
Manguito Macho-Macho Hose connection Male-Male Manchette de raccordement Mâle-Mâle 200 mm		Ref.	5551100	5551110	5551120	5551150	5551175	5551200
		€   U.	17,05   1	17,20   1	17,35   1	19,30   1	21,95   1	30,95   1
Manguito Hembra-Hembra Hose connection Female-Female Manchette de raccordement Femelle-Femelle 200 mm		Ref.	5552100	5552110	5552120	5552150	5552175	5552200
		€   U.	17,05   1	17,20   1	17,35   1	19,30   1	21,95   1	30,95   1
Reducción   Reduction Adapter   Réduction Ø 110		Ref.	5541100					
		€   U.	23,50   1					
Reducción   Reduction Adapter   Réduction Ø 120		Ref.	5542100	5542110				
		€   U.	23,90   1	24,20   1				
Reducción   Reduction Adapter   Réduction Ø 140		Ref.			5543120			
		€   U.			26,55   1			
Reducción   Reduction Adapter   Réduction Ø 150		Ref.			5544120			
		€   U.			29,50   1			
Reducción   Reduction Adapter   Réduction Ø 175		Ref.				5545150		
		€   U.				36,80   1		
Reducción   Reduction Adapter   Réduction Ø 200		Ref.				5546150	5546175	
		€   U.				47,70   1	49,85   1	



Ref.	5501150	Unidades de embalaje Packing units Unités d'emballage
€   U.	27,85   17	

Gama negro mate | Matt black range | Gamme noir mat

VITRIFICADO A 900°C

900°C VITRIFIED

VITRIFIÉ À 900°C

		Diámetro / diameter / diamètre Ø	120	125	150	175	200
		Espesor total / Total thickness / Épaisseur total	1,2				
Tubo Pipe Conduit 1.000 mm		Ref.	5601120	5601125	5601150	5601175	5601200
		€   U.	38,00   6	38,45   5	40,75   3	46,30   2	52,60   2
Tubo Pipe Conduit 500 mm		Ref.	5602120	5602125	5602150	5602175	5602200
		€   U.	28,40   12	28,50   10	30,55   6	33,15   4	37,60   4
Tubo con llave Pipe with Tap Conduit clé 1.000 mm		Ref.	5605120	5605125	5605150	5605175	5605200
		€   U.	57,20   6	57,85   5	63,20   3	72,25   2	81,20   2
Tubo telescópico Insertable pipe Conduit télescopique 200 mm		Ref.	5606120	5606125	5606150	5606175	5606200
		€   U.	84,00   1	84,20   1	88,45   1	98,95   1	107,50   1
Codo Elbow Coude 45°		Ref.	5615120	5615125	5615150	5615175	5615200
		€   U.	31,40   10	31,75   10	35,45   10	38,35   10	44,00   10
Codo Elbow Coude 90°		Ref.	5616120	5616125	5616150	5616175	5616200
		€   U.	39,60   8	39,90   8	44,15   8	51,70   8	59,10   8
Te 90° con tapa "T" piece 90° with Cover Té 90° avec tampon		Ref.	5621120	5621125	5621150	5621175	5621200
		€   U.	72,80   10	73,85   6	80,45   6	103,75   4	132,55   4
Plafón (rosetón) Rosette Rosace		Ref.	5661120	5661125	5661150	5661175	5661200
		€   U.	17,70   1	18,45   1	20,55   1	24,55   1	26,85   1

# 8 CF

Conducto Flexible  
Flexible Piping  
*Conduit Flexible*

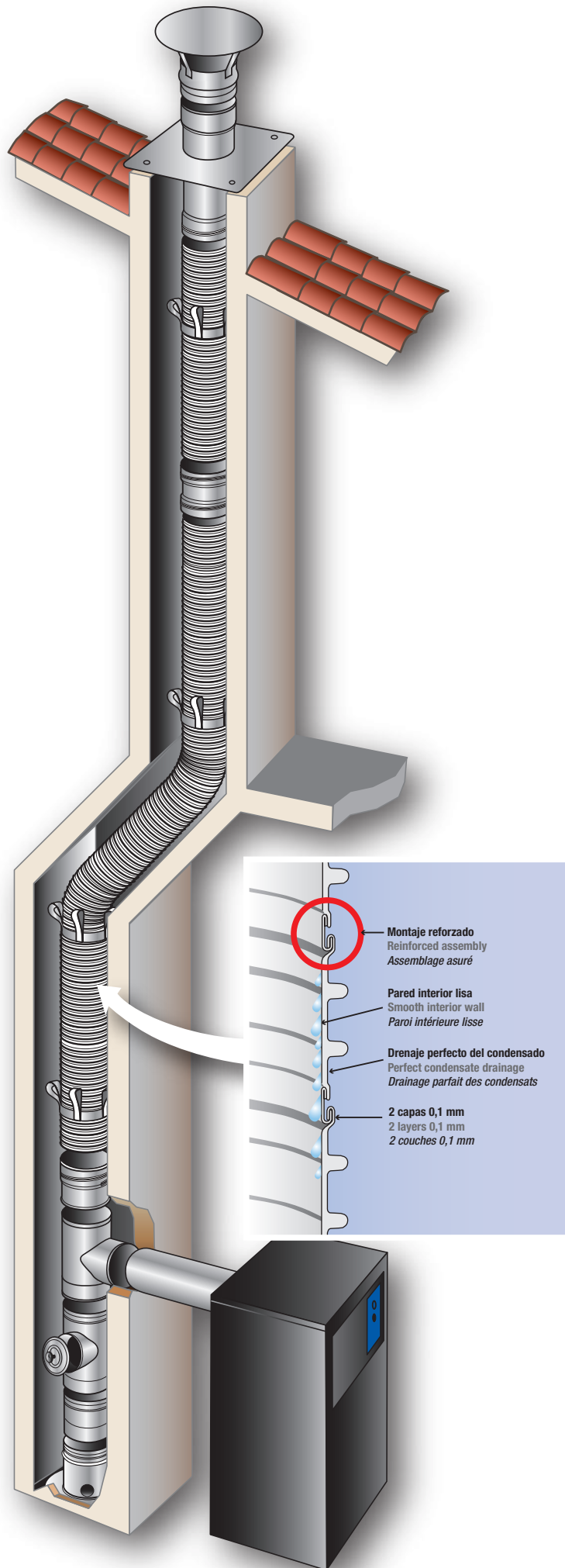

**CE** Especificaciones de acuerdo a la legislación europea en productos de construcción **CPR**  
Specifications according to EU product regulations of construction **CPR**  
Spécifications Selon la réglementation européenne concernant les produits de construction **CPR**



**AISI 316L**

(1.4404)

**1856-2**

T200 P1 W Vm L50010 O

T450 N1 D Vm L50010 G



**AISI 904L**

(1.4539)

**1856-2**

T200 P1 W Vm L70010 O

T450 N1 D Vm L70010 G

**Radio máximo curvatura**  
**Maximum radius of curvature**  
*Rayon de courbure maximum*

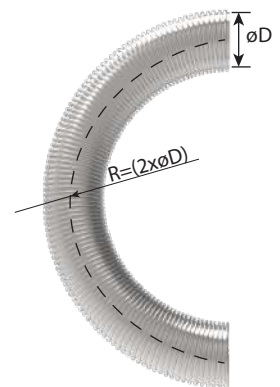

**Empaquetado | Packaging | Emballage**

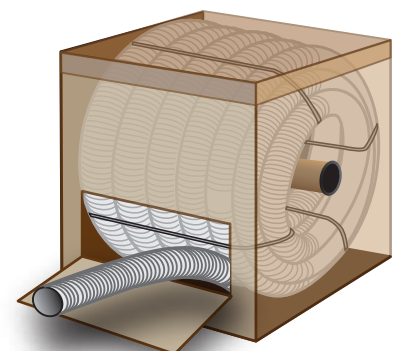

### Tubo flexible - doble capa | Flexible piping - double layer | Conduit flexible - double couche



		ØD mm						
		80	90	100	110	120	125	130
AISI 316L-304	Ref.	2700986	2700987	2700988	2700989	2700990	2700991	2700945
	€ m.	27,20 <sup>60</sup>	30,15 <sup>60</sup>	32,95 <sup>55</sup>	37,10 <sup>55</sup>	40,00 <sup>50</sup>	41,40 <sup>50</sup>	42,95 <sup>50</sup>
AISI 316L-316L	Ref.	4015218	4015219	4015220	4015221	4015222	4015223	4015224
	€ m.	30,85 <sup>60</sup>	34,25 <sup>60</sup>	37,70 <sup>55</sup>	42,15 <sup>55</sup>	45,70 <sup>50</sup>	47,20 <sup>50</sup>	49,00 <sup>50</sup>

### Manguito flex-flex | Flex-flex hose | Manchette flex-flex



		ØD mm						
		80	90	100	110	120	125	130
AISI 316L	Ref.	4020978	4020979	4020980	4020981	4020982	4020983	4020984
	€ U.	49,65 <sup>1</sup>	50,05 <sup>1</sup>	50,25 <sup>1</sup>	50,90 <sup>1</sup>	53,00 <sup>1</sup>	54,10 <sup>1</sup>	55,50 <sup>1</sup>

### Manguito unión flex silicona-flex silicona | Silicone flex-silicone flex hose connection | Manchette de raccordement flex silicone-flex silicone



		ØD mm						
		80	90	100	110	120	125	130
AISI 316L	Ref.	4016319	4018117	4018118	-	4018119	4018120	4018121
	€ U.	66,35 <sup>1</sup>	74,00 <sup>1</sup>	80,65 <sup>1</sup>	-	132,00 <sup>1</sup>	137,25 <sup>1</sup>	137,25 <sup>1</sup>

### Manguito unión macho-flex | Male-flex hose connection | Manchette de raccordement mâle-flex



		ØD mm						
		80	90	100	110	120	125	130
AISI 316L	Ref.	4017250	4026065	4017259	4017260	4017269	4017270	4017330
	€ U.	41,90 <sup>1</sup>	44,30 <sup>1</sup>	45,30 <sup>1</sup>	45,70 <sup>1</sup>	47,70 <sup>1</sup>	49,40 <sup>1</sup>	51,10 <sup>1</sup>
ØD SP		80	80	100	100	125	125	130

### Manguito unión macho-flex silicona | Silicone male-flex hose connection | Manchette de raccordement mâle-flex silicone



		ØD mm						
		80	90	100	110	120	125	130
AISI 316L	Ref.	4016321	4018107	4018108	-	4018109	4018110	4018111
	€ U.	37,45 <sup>1</sup>	42,15 <sup>1</sup>	45,30 <sup>1</sup>	-	72,05 <sup>1</sup>	75,35 <sup>1</sup>	75,35 <sup>1</sup>
ØD SP		80	100	100	-	125	125	130

### Manguito unión flex-hembra | Female-flex hose connection | Manchette de raccordement flex-femelle



		ØD mm						
		80	90	100	110	120	125	130
AISI 316L	Ref.	4017142	4023522	4017143	4017157	4017158	4017168	4017169
	€ U.	45,30 <sup>1</sup>	46,70 <sup>1</sup>	47,70 <sup>1</sup>	48,90 <sup>1</sup>	51,50 <sup>1</sup>	51,65 <sup>1</sup>	53,15 <sup>1</sup>
ØD SP		80	80	100	110	125	125	130

### Terminal obra sin ventilar flex | Flex non-ventilated end piece | Solin toit plat non ventilé flex



		ØD mm						
		80	90	100	110	120	125	130
AISI 316L	Ref.	4024638	4024640	4024896	4024641	4024643	4024644	4024645
	€ U.	100,95 <sup>1</sup>	101,45 <sup>1</sup>	101,90 <sup>1</sup>	102,65 <sup>1</sup>	111,95 <sup>1</sup>	112,55 <sup>1</sup>	117,95 <sup>1</sup>
ØD SP		80	80	100	110	125	125	130

Medidas | Measurements | Mesures

□ A		400	400	400	400	400	400	400
-----	--	-----	-----	-----	-----	-----	-----	-----

### Abrazadera de araña | Spider bracket | Bride araignée



		ØD mm						
		80	90	100	110	120	125	130
AISI 304	Ref.	4008372	4018692	4018448	4018693	4018694	4018695	4013533
	€ U.	48,60 <sup>1</sup>	49,15 <sup>1</sup>	50,05 <sup>1</sup>	51,45 <sup>1</sup>	51,65 <sup>1</sup>	51,95 <sup>1</sup>	53,30 <sup>1</sup>

### Abrazadera terminal flexible | Flexible end-piece bracket | Collier haut de tubage flexible



		ØD mm						
		80	90	100	110	120	125	130
AISI 304	Ref.	4015960	4020581	4015962	4020583	4018310	4016065	4020589
	€ U.	33,70 <sup>1</sup>	34,95 <sup>1</sup>	36,40 <sup>1</sup>	37,55 <sup>1</sup>	38,85 <sup>1</sup>	39,60 <sup>1</sup>	40,15 <sup>1</sup>

Ref.	4020986	Unidades de embalaje Packing units Unités d'emballage
€ U.	55,85 <sup>1</sup>	

140	150	160	180	200	220	230	250
2700992	2700854	2700855	2700856	4008034	2700993	4021154	2700858
45,75 <sup>50</sup>	49,80 <sup>40</sup>	53,10 <sup>40</sup>	59,75 <sup>30</sup>	65,90 <sup>30</sup>	76,60 <sup>20</sup>	79,45 <sup>10</sup>	90,35 <sup>10</sup>
4015225	4015226	4015227	4015228	4015229	4015230	4021152	4015231
52,25 <sup>50</sup>	56,70 <sup>40</sup>	60,65 <sup>40</sup>	67,95 <sup>30</sup>	73,30 <sup>30</sup>	84,60 <sup>20</sup>	87,95 <sup>20</sup>	96,55 <sup>10</sup>



140	150	160	180	200	220	230	250
4020985	4020986	4020987	4020988	4020989	4020990	4020505	4020991
55,60 <sup>1</sup>	55,85 <sup>1</sup>	57,20 <sup>1</sup>	58,00 <sup>1</sup>	62,10 <sup>1</sup>	62,80 <sup>1</sup>	63,80 <sup>1</sup>	64,00 <sup>1</sup>



140	150	160	180	200	220	230	250
4018122	4018123	4018124	-	-	-	-	-
146,25 <sup>1</sup>	156,55 <sup>1</sup>	175,90 <sup>1</sup>	-	-	-	-	-

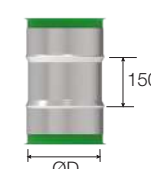

140	150	160	180	200	220	230	250
-	4017342	4017343	4017354	4017355	4027248	4027250	4017366
-	54,15 <sup>1</sup>	55,45 <sup>1</sup>	56,30 <sup>1</sup>	60,20 <sup>1</sup>	61,25 <sup>1</sup>	61,70 <sup>1</sup>	62,20 <sup>1</sup>
-	150	150	180	200	230	230	250



140	150	160	180	200	220	230	250
-	4018114	4018116	-	-	-	-	-
-	86,45 <sup>1</sup>	97,15 <sup>1</sup>	-	-	-	-	-
-	150	150	-	-	-	-	-

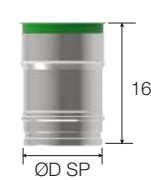

140	150	160	180	200	220	230	250
-	4017190	4017191	4017201	4017202	4017237	4023526	4017238
-	54,85 <sup>1</sup>	56,20 <sup>1</sup>	57,15 <sup>1</sup>	61,00 <sup>1</sup>	61,80 <sup>1</sup>	64,00 <sup>1</sup>	66,60 <sup>1</sup>
-	150	150	180	200	230	230	250



140	150	160	180	200	220	230	250
-	4024647	4024648	4024649	4024650	4024651	4024652	4024653
-	119,70 <sup>1</sup>	124,25 <sup>1</sup>	128,75 <sup>1</sup>	130,40 <sup>1</sup>	135,60 <sup>1</sup>	140,60 <sup>1</sup>	152,70 <sup>1</sup>
-	150	150	180	200	230	230	250

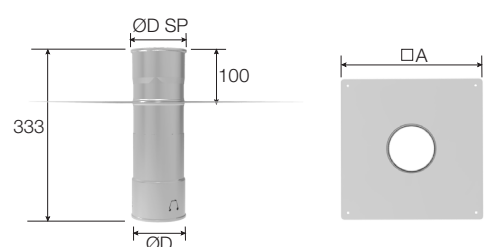

-	400	400	400	450	450	500	500
---	-----	-----	-----	-----	-----	-----	-----

140	150	160	180	200	220	230	250
-	4009721	4025627	4012491	4016687	4025628	4027251	4025629
-	55,10 <sup>1</sup>	57,20 <sup>1</sup>	58,15 <sup>1</sup>	61,45 <sup>1</sup>	61,70 <sup>1</sup>	62,40 <sup>1</sup>	62,50 <sup>1</sup>

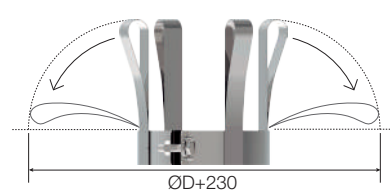

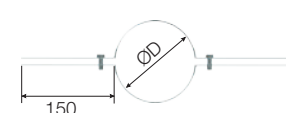

140	150	160	180	200	220	230	250
-	4016223	4020590	4016176	4020591	4023494	4023519	4018772
-	41,50 <sup>1</sup>	43,90 <sup>1</sup>	46,00 <sup>1</sup>	48,30 <sup>1</sup>	50,25 <sup>1</sup>	52,20 <sup>1</sup>	54,20 <sup>1</sup>

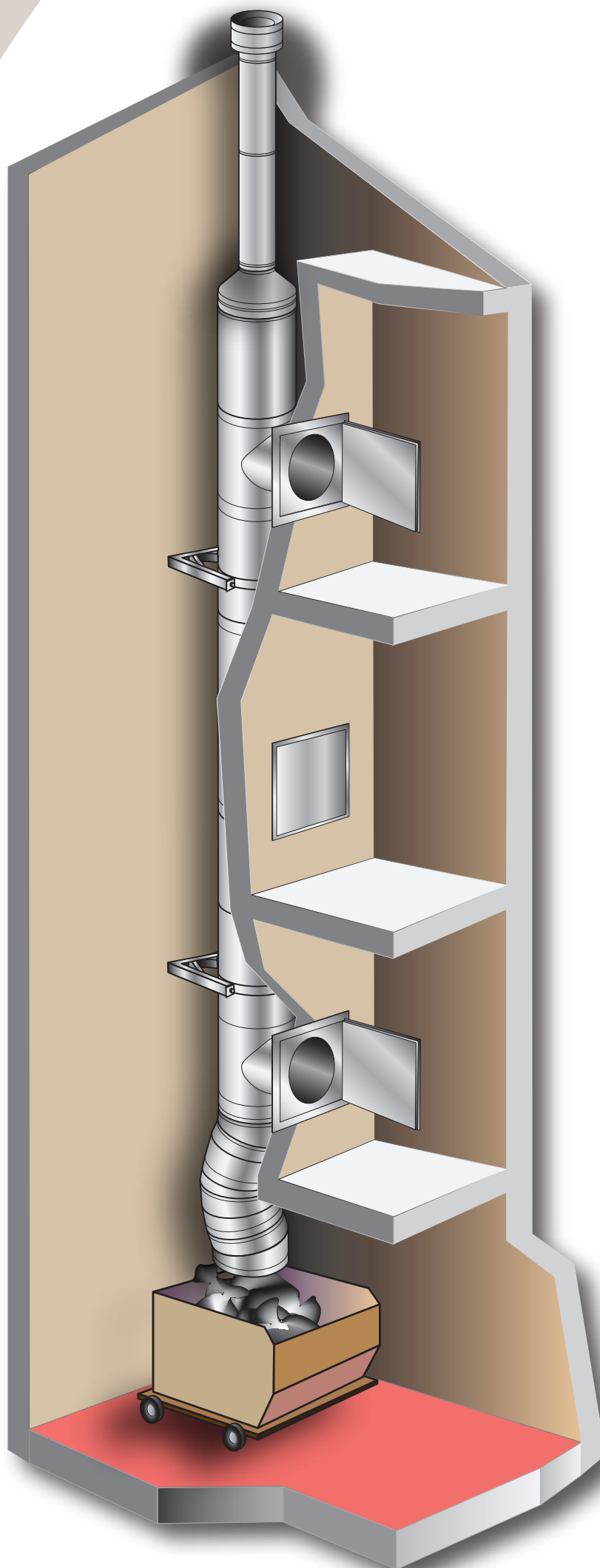

# 9 BD

Bajante de Descarga  
Refuse Chute  
*Conduit de chute*



Espesor Thickness Épaisseur		ø400 ..... <b>0,5 mm</b>
		ø450-600 ..... <b>0,6 mm</b>

El **DB HS2** “Recogida y evacuación de residuos”, establece como exigencia básica que los edificios dispongan de espacios y medios para extraer los residuos generados por ellos en consonancia con el sistema público de recogida facilitando la adecuada separación en origen de dichos residuos para su posterior gestión.

Este sistema de bajante de descarga, destinado a la recogida y evacuación de materiales diversos embolsados, permite la recogida de bolsas de ropa sucia o basura en hospitales, hoteles, comunidades, centros comerciales, etc. Cumple con las especificaciones descritas en el documento básico del código de la edificación **DB HS2** sobre salubridad en la recogida y evacuación de residuos.

The **DB HS2** standard “Collection and disposal of waste”, establishes the basic requirement that buildings have spaces and means to extract the waste generated by them in line with the public collection system, providing adequate separation at source of waste for subsequent management.

This refuse chute system, for the collection and removal of different types of bagged materials, can be used to collect bags of dirty laundry or refuse in hospitals, hotels, communities, shopping centres, etc. It complies with the specifications described in the basic document of the **DB HS2** building code on health and safety in waste collection and disposal.

*La norme **DB HS2** “Collecte et élimination des déchets”, établit l’exigence de base selon laquelle les bâtiments doivent disposer d’espaces et de moyens pour extraire les déchets qu’ils génèrent, conformément au système de collecte public, en assurant une séparation adéquate à la source des déchets en vue d’une gestion ultérieure.*

*Ce système de conduit de chute vide-ordures/vide-linge, pour la collecte et l’élimination de matériaux divers en sacs, permet la collecte de sacs de linge sale ou d’ordures dans les hôpitaux, les hôtels, les copropriétés, les centres commerciaux, etc. Il est conforme aux spécifications décrites dans le document de base du code du bâtiment **DB HS2** sur la salubrité dans la collecte et l’élimination des déchets.*

#### Módulo lineal | Linear module | Élément droit

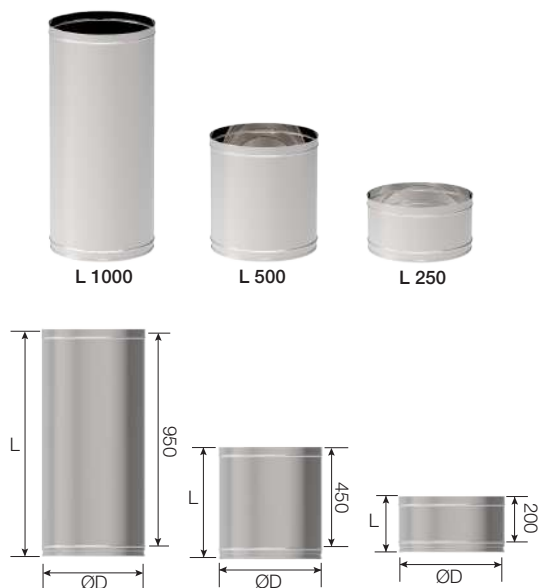

ØD mm    200    450    500    550    600

#### L 1000 mm

AISI 304	Ref.	2700308	4029576	4029699	4029850	4030039
	€ U.	<b>53,00</b>	<b>158,45</b>	<b>185,90</b>	<b>229,20</b>	<b>276,80</b>
AISI 316L	Ref.	4009357	4028610	4029746	4029926	4030065
	€ U.	<b>72,30</b>	<b>191,35</b>	<b>245,80</b>	<b>307,60</b>	<b>376,35</b>

#### L 500mm

AISI 304	Ref.	2700307	4029578	4029701	4029852	4030041
	€ U.	<b>32,65</b>	<b>94,25</b>	<b>111,75</b>	<b>141,65</b>	<b>172,65</b>
AISI 316L	Ref.	4014390	4029645	4029748	4029928	4030067
	€ U.	<b>44,55</b>	<b>126,25</b>	<b>147,45</b>	<b>189,75</b>	<b>234,80</b>

#### L 250 mm

AISI 304	Ref.	2700306	4029577	4029700	4029851	4030040
	€ U.	<b>23,25</b>	<b>88,60</b>	<b>109,10</b>	<b>134,60</b>	<b>162,40</b>
AISI 316L	Ref.	4014829	4029644	4029747	4029927	4030066
	€ U.	<b>31,70</b>	<b>107,30</b>	<b>144,05</b>	<b>180,25</b>	<b>220,85</b>

#### Módulo extensible | Extendable module | Élément télescopique

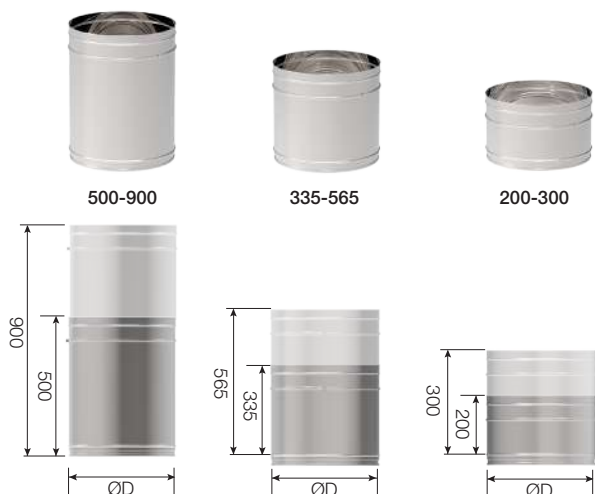

ØD mm    200    450    500    550    600

#### Lmin 500 mm - Lmax 900 mm

AISI 304	Ref.	-	4029565	4029684	4029825	4030026
	€ U.	-	<b>273,80</b>	<b>328,85</b>	<b>397,95</b>	<b>458,55</b>
AISI 316L	Ref.	-	4029628	4029732	4029899	4030050
	€ U.	-	<b>348,10</b>	<b>433,95</b>	<b>533,15</b>	<b>623,60</b>

#### Lmin 335 mm - Lmax 565 mm

AISI 304	Ref.	-	4029564	4029683	4029824	4030025
	€ U.	-	<b>194,75</b>	<b>234,30</b>	<b>283,70</b>	<b>326,00</b>
AISI 316L	Ref.	-	4029627	4029724	4029898	4030049
	€ U.	-	<b>241,90</b>	<b>309,25</b>	<b>380,05</b>	<b>443,35</b>

#### Lmin 200 mm - Lmax 300 mm

AISI 304	Ref.	-	4032467	4032468	4032469	4032470
	€ U.	-	<b>163,05</b>	<b>194,95</b>	<b>238,65</b>	<b>277,15</b>
AISI 316L	Ref.	-	4032472	4032473	4032474	4032475
	€ U.	-	<b>197,30</b>	<b>257,20</b>	<b>319,65</b>	<b>376,95</b>

#### Codo | Elbow | Coude 15°



ØD mm    450    500    550    600

AISI 304	Ref.	4029559	4029679	4029818	4030016
	€ U.	<b>139,60</b>	<b>172,85</b>	<b>212,75</b>	<b>259,20</b>
AISI 316L	Ref.	4029617	4029719	4029868	4030045
	€ U.	<b>188,45</b>	<b>214,00</b>	<b>265,80</b>	<b>322,95</b>

Medidas | Measurements | Mesures

	H	43	44	45	46
	V	282	288	295	301

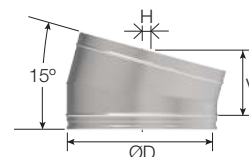

#### Te embranque | "T" Piece branch | Té branche 90°



ØD mm    450    500    550    600

AISI 304	Ref.	4040170	4040171	4040172	4040173
	€ U.	<b>316,10</b>	<b>376,40</b>	<b>458,55</b>	<b>537,60</b>
AISI 316L	Ref.	4040184	4040185	4040186	4040187
	€ U.	<b>373,90</b>	<b>447,35</b>	<b>527,70</b>	<b>619,40</b>

Medidas | Measurements | Mesures

	L	660	710	760	810
	H	340	365	390	415
	V	306	331	356	381

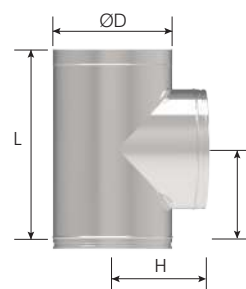



Ref.	4029699	Unidades de embalaje
€ U.	185,90	Packing units
		Unités d'emballage

### Reducción | Reduction adapter | Réduction



		ØD mm			
		450	500	550	600
AISI 304	Ref.	4040217	4040218	4040219	4040220
	€ U.	174,70	232,55	289,25	348,85
AISI 316L	Ref.	4040221	4040222	4040223	4040224
	€ U.	209,65	279,05	347,10	418,55

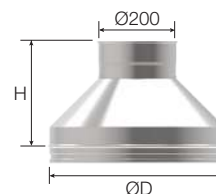

Medidas   Measurements   Mesures					
H		271	296	321	346

### Sombrero antiretorno | Non-return cap | Chapeau anti-refoulement



		ØD mm	
		200	
AISI 304	Ref.	2700310	
	€ U.	118,25	
AISI 316L	Ref.	4016443	
	€ U.	162,40	



### Abrazadera mural interior | Internal wall band | Collier support mural intérieur



		ØD mm				
		200	450	500	550	600
AISI 304	Ref.	2500041	4035019	4035066	4035067	4035068
	€ U.	17,75	104,00	117,10	128,50	137,85

### Abrazadera forjado reforzada | Reinforced ceiling bracket | Collier étage renforcé



		ØD mm				
		200	450	500	550	600
AISI 304	Ref.	9023221	4023226	4026831	4026832	4026833
	€ U.	52,15	66,60	68,60	73,05	81,35

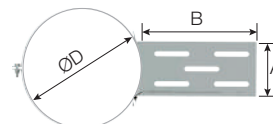

### Abrazadera de unión tornillo | Connection bracket, screwed | Collier de fixation à vis



		ØD mm				
		200	450	500	550	600
AISI 304	Ref.	5003970	5004828	5004829	5004830	5004831
	€ U.	5,15	17,25	19,55	22,00	24,45

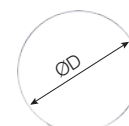

### Junta silicona | Silicone gasket | Joint silicone



		ØD mm				
		200	450	500	550	600
Ref.		5003954	5005716	5005717	5005718	5005719
€ U.		4,15	16,15	19,35	22,40	25,85

### Puerta y Adaptador a Te embranche | Door and "T" Piece branch adapter | Trappe et adaptateur à Té branche



**EI<sub>2</sub>60**

**Acabados y tarifa de precios, consulte al Departamento Comercial.**  
**Finishes and price list on request, consult Sales Department.**  
**Finitions et tarifs sur demande, consultez le Service Commercial.**



# 10 AC

Accesorios  
Accessories  
Accessoires

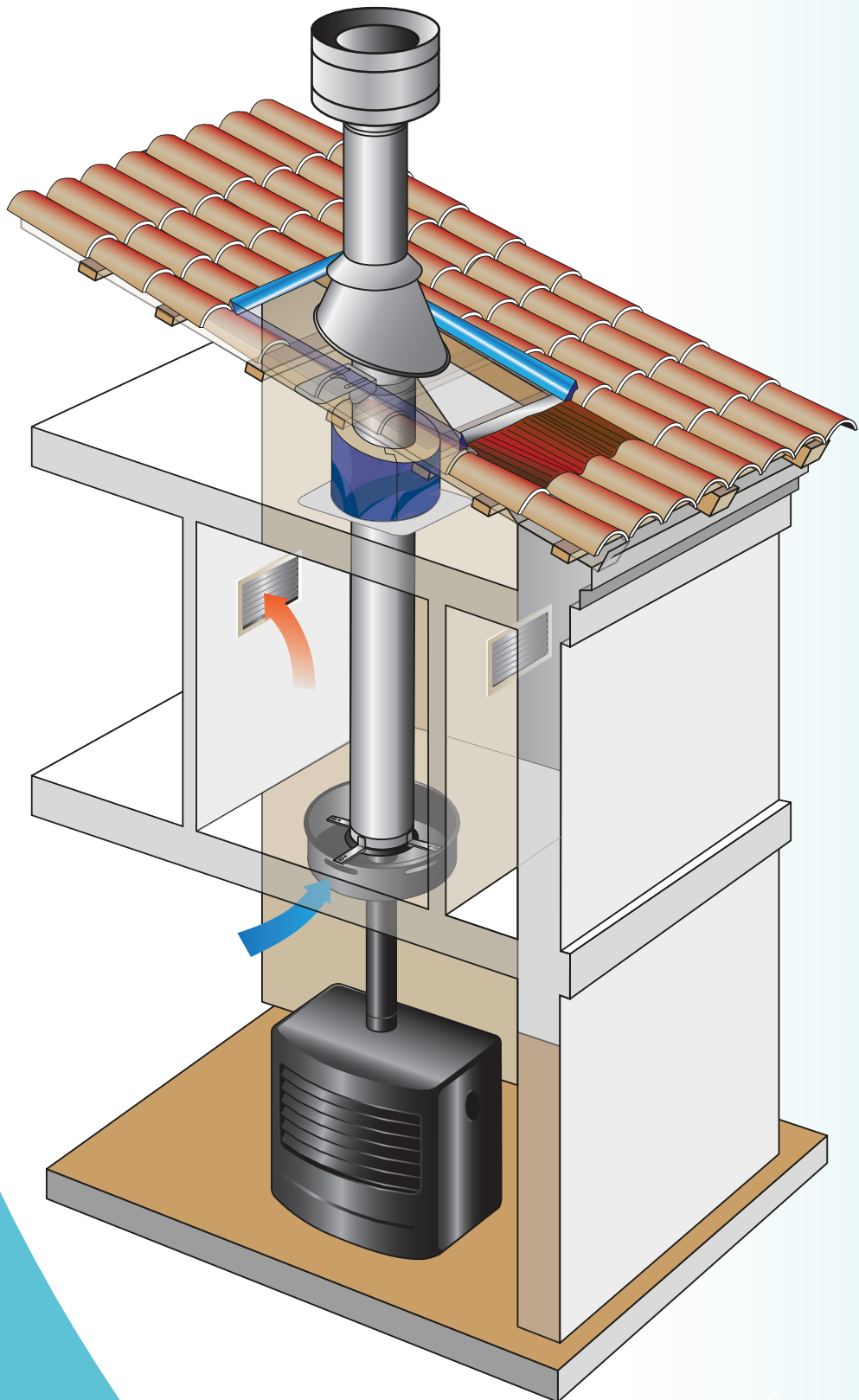

**Cubreaguas, salidas de techo y accesorios**  
**Roof flashing, rooftops and accessories**  
*Solins, sorties de toit et accessoires*

**CE** Especificaciones de acuerdo a la legislación europea en productos de construcción **CPR**  
Specifications according to EU product regulations of construction **CPR**  
*Spécifications Selon la réglementation européenne concernant les produits de construction **CPR***

SP - F - BD	Ø	80	100	110	125	130	150	180	200	230	250
DP - EI	Ø					80	100	125 - 130	150	180	200
CC	Ø				80/125	80/130	100/150	110/180	130/200		150/250
DP50	Ø									130	150

### Cubreaguas inox horizontal | Horizontal steel roof flashing | Solin inox horizontal + Collarín | Storm collar | Collettere 75mm



AISI 304	Ref.	2700944	2700939	4019534	4013886	2700940	2700868	2700941	2700807	2500210	2700942
	€ U.	<b>98,80</b>	<b>103,00</b>	<b>114,35</b>	<b>116,75</b>	<b>119,45</b>	<b>129,70</b>	<b>136,20</b>	<b>155,90</b>	<b>157,10</b>	<b>163,70</b>

### Cubreaguas inox inclinado | Inclined stainless steel roof flashing | Solin inox incliné + Collarín | Storm collar | Collettere 75mm

5° - 25°

AISI 304	Ref.	4026713	4026715	4026716	4026717	4026718	4026720	4026721	4026722	4026723	4026724
	€ U.	<b>192,90</b>	<b>196,25</b>	<b>201,10</b>	<b>201,40</b>	<b>202,15</b>	<b>203,10</b>	<b>217,95</b>	<b>225,95</b>	<b>240,55</b>	<b>247,30</b>

25° - 45°

AISI 304	Ref.	4026730	4026731	4026732	4026733	4026734	4026736	4026737	4026738	4026740	4026741
	€ U.	<b>194,75</b>	<b>200,60</b>	<b>203,10</b>	<b>203,45</b>	<b>204,25</b>	<b>205,15</b>	<b>220,00</b>	<b>228,65</b>	<b>242,75</b>	<b>249,80</b>

45° - 60°

AISI 304	Ref.	4026745	4026746	4026748	4026749	4026751	4026753	4026755	4026756	4026757	4026759
	€ U.	<b>214,25</b>	<b>219,65</b>	<b>223,40</b>	<b>223,80</b>	<b>224,55</b>	<b>225,70</b>	<b>242,20</b>	<b>251,85</b>	<b>267,45</b>	<b>274,75</b>

### Cubreaguas de plomo inclinado | Inclined lead roof flashing | Solin en plomb incliné + Collarín | Storm collar | Collettere 75mm

5° - 25°

AISI 304 / Pb	Ref.	4007495	4007496	4019535	4013887	4007497	4007498	4007499	4007500	4007501	4007502
	€ U.	<b>214,10</b>	<b>219,20</b>	<b>228,20</b>	<b>235,95</b>	<b>236,40</b>	<b>251,85</b>	<b>258,95</b>	<b>275,85</b>	<b>288,30</b>	<b>299,60</b>

25° - 45°

AISI 304 / Pb	Ref.	4007506	4007507	4019538	4013888	4007508	4007509	4007510	4007511	4007512	4007513
	€ U.	<b>240,10</b>	<b>244,75</b>	<b>250,10</b>	<b>251,20</b>	<b>252,30</b>	<b>258,75</b>	<b>275,60</b>	<b>293,65</b>	<b>306,85</b>	<b>318,90</b>

45° - 60°

AISI 304 / Pb	Ref.	4021908	4021909	4021911	4021912	4021913	4021915	4008453	4008452	4014086	4014381
	€ U.	<b>258,10</b>	<b>263,05</b>	<b>268,85</b>	<b>270,10</b>	<b>271,20</b>	<b>278,10</b>	<b>296,25</b>	<b>315,75</b>	<b>342,85</b>	<b>357,95</b>

### Cubreaguas atornillar | Screwed roof flashing | Solin à visser

	ØD	80-180			200-300			350-700					
		Ref.	5003944	5003946	5005824	Ref.	5005825	5005826	5005827	Ref.	5005825	5005826	5005827
EPDM (< 150°C)		€ U.	<b>52,40</b>	<b>132,50</b>	<b>573,75</b>								
SILICONE (< 200°C)		€ U.	<b>78,85</b>	<b>188,85</b>	<b>990,80</b>								



### Kit fijación | Fastening kit | Kit fixation

	ØD	80-180		200-700		
		Ref.	4035361	4035363	Ref.	4035361
€ U.		<b>22,30</b>	<b>36,40</b>			

### Cubreaguas residencial aluminio | Aluminum residential roof flashing | Solin résidentiel en aluminium

	ØD	80 - 200				230 - 250				300 - 450				350 - 700			
		Ref.	5005829	5005830	-	5005831	Ref.	5005832	5005833	5005834	-	Ref.	5005832	5005833	5005834	-	
EPDM (< 150°C)		€ U.	<b>112,25</b>	<b>163,80</b>	-	<b>343,55</b>											
SILICONE (< 200°C)		€ U.	<b>128,80</b>	<b>181,55</b>	<b>413,45</b>	-											



### Prolongación mural (2 u.) | Wall extension (2 u.) | Rallonge murale (2 u.)

AISI 304	L	50 mm				150 mm				250 mm				1000 mm			
		Ref.	4019958	4019959	4019960	5004655	Ref.	4019958	4019959	4019960	5004655	Ref.	4019958	4019959	4019960	5004655	
€ U.		<b>32,75</b>	<b>41,80</b>	<b>51,95</b>	<b>251,00</b>												

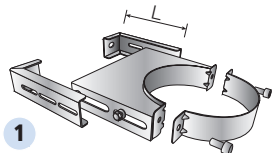

Para abrazadera mural interior y exterior (Ø80-Ø250)  
For interior and external wall bracket (Ø80-Ø250)  
Pour collier support mural intérieur et extérieur (Ø80-Ø250)

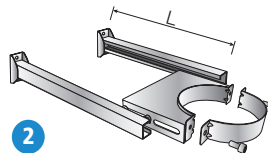

Para abrazadera mural interior (Ø300-Ø650) y exterior (Ø80-Ø650)  
For interior (Ø300-Ø650) and external wall bracket (Ø80-Ø650)  
Pour collier support mural intérieur (Ø300-Ø650) et extérieur (Ø80-Ø650)

Ref.	2700868	Unidades de embalaje
€ U.	121,20	Packing units
		Unités d'emballage

300	350	400	450	500	550	600	650	700
250	300	350	400	450	500	550	600	650
180/300	200/350	250/400						
200	250	300	350	400	450	500	550	600

2700943	2700938	4009572	2500214	5002662	4009579	4009580	4009581	4009582
223,90	278,60	350,00	379,60	417,70	473,50	516,20	537,95	560,20

4026725	4026726	4026727	-	-	-	-	-	-
286,30	332,00	388,00	-	-	-	-	-	-

4026742	4026743	4026744	-	-	-	-	-	-
307,90	359,30	397,70	-	-	-	-	-	-

4026760	4026762	4026763	-	-	-	-	-	-
339,55	351,30	437,50	-	-	-	-	-	-

4007503	4007504	4007505	-	-	-	-	-	-
318,90	341,40	376,45	-	-	-	-	-	-

4007514	4007515	4007516	-	-	-	-	-	-
339,45	363,35	400,65	-	-	-	-	-	-

4014382	4021916	4021918	-	-	-	-	-	-
364,90	390,65	430,75	-	-	-	-	-	-

Babero | Bib | Bavette

RAL 7022

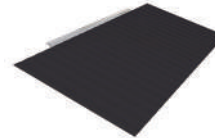

Accesorio para \*  
Accessory for  
Accessoire pour

Ref.	4025975
€ U.	83,50

RAL 8004

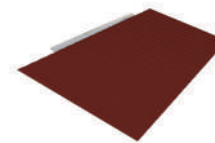

Ref.	4025978
€ U.	83,50

Espuma poliéster autoadhesiva para cubreaguas 1m

Self-adhesive polyester foam for roof flashing 1m  
Mousse polyester autocollante pour solin 1m



Ref.	2045889
€ U.	5,15

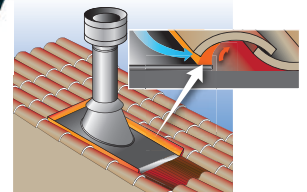

Fijación forjado angular (2 unidades) | Angular forged fixation (2 units) | Fixation angulaire (2 unités)



GALVANIZADO  
GALVANIZED  
GALVANISÉ

1000 mm	
Ref.	4026057
€ U.	51,70

Kit prolongación forjado | Forged extension kit | Kit extension étage



GALVANIZADO  
GALVANIZED  
GALVANISÉ

ØDi mm	80 - 100 - 125 - 130 - 150	180 - 200
Ref.	4026038	4026042
€ U.	96,30	134,75

2 3 Consultar las diferentes opciones de soporte en la página 143 | For support options, see page 143 | Pour les options d'assistance, voir page 143.

Kit fijación reforzado universal (2 unidades) | Universal reinforced fastening kit (2 units) | Kit fixation renforcé universel (2 unités)

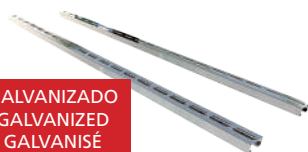

GALVANIZADO  
GALVANIZED  
GALVANISÉ

1000 mm	
Ref.	4026055
€ U.	62,50

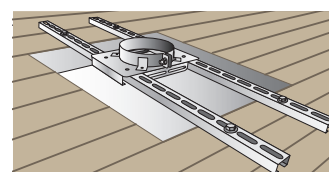

Kit fijación soporte  
mural universal  
Universal wall support kit  
Kit support mural universel

SP - F - BD	Ø	80	100	110	125	130	150	180	200	230	250
DP - EI	Ø					80	100	125 - 130	150	180	200
CC	Ø				80/125	80/130	100/150	110/180	130/200		150/250
DP50	Ø									130	150

### Collarín | Storm collar | Colletterte

75 mm	AISI 304	Ref.	4019980	4019981	4019982	4021061	4019983	4019984	4019985	4019986	4019987	4019988
		€ U.	30,10	30,30	30,95	31,60	32,35	37,85	41,85	45,30	50,70	56,55

30 mm	AISI 304	Ref.	4019715	4019716	4019717	4022454	4019718	4019720	4019721	4019722	4019923	4019723
		€ U.	27,35	27,60	28,20	30,10	31,30	34,50	40,95	44,30	46,10	51,50

### Rosetón | Finishing collar | Rosace

AISI 304	Ref.	4007378	2700643	4022496	4013910	2700632	2700633	4008224	4011484	4022498	4011483
	€ U.	26,85	28,40	30,10	33,25	34,15	35,60	39,15	40,80	43,30	45,65

Medidas | Measurements | Mesures

ØDe	200	200	200	230	230	250	300	300	350	350
-----	-----	-----	-----	-----	-----	-----	-----	-----	-----	-----

### Embelcedor techo horizontal 1 pieza | Horizontal sloping roof trim 1 unit | Plaque de finition 1 pièce

AISI 304	Ref.	4014804	4015186	4019542	4022448	4014805	4014806	4015187	4015188	4012816	4013363
	€ U.	24,80	25,50	26,45	27,45	28,50	33,15	43,40	50,95	59,60	70,45

### Embelcedor techo horizontal 2 piezas | Horizontal sloping roof trim 2 units | Plaque de finition 2 pièces

AISI 304	Ref.	4019832	4019833	4019835	4022449	4019836	4019837	4019838	4019839	4019840	4019841
	€ U.	28,50	30,10	30,40	31,55	32,75	38,00	40,50	58,60	68,50	80,95

### Embelcedor techo inclinado 2 piezas | Sloping inclined roof trim 2 units | Plaque de finition toit incliné 2 pièces

5° - 25°	AISI 304	Ref.	4015180	4015181	4019543	4022447	4015182	4015183	4015184	4015185	4013415	4013417
		€ U.	30,70	32,35	32,70	33,90	35,30	40,95	43,50	63,05	73,70	87,05

25° - 45°	AISI 304	Ref.	4013413	4015122	4019544	4022446	4015123	4015177	4015178	4015179	4012817	4013362
		€ U.	32,40	34,05	34,60	35,80	37,25	43,20	45,85	66,40	77,70	91,90

45° - 60°	AISI 304	Ref.	4017680	4017681	4017682	4017683	4017684	4017686	4017687	4017688	4017689	4017690
		€ U.	34,60	34,65	36,90	38,20	39,70	46,85	49,00	70,85	82,90	98,05

### Distanciador fuego | Firebreak | Plaque écart au feu

AISI 304	Ref.	4019112	4019113	4022464	4019114	4018288	4019115	4018697	4018698	4018699	4018700
	€ U.	65,10	65,65	66,20	66,70	66,95	71,00	73,80	75,50	83,05	91,70

### Distanciador fuego ventilado | Ventilated firebreak | Plaque écart au feu ventilée

AISI 304	Ref.	4016780	4016781	4022462	4016782	4016783	4016784	4016785	4016786	4016428	4016407
	€ U.	72,30	72,90	73,50	74,05	74,40	74,75	82,00	83,85	92,25	101,90

### Distanciador de fuego HETAS | Firebreak HETAS | Plaque écart au feu HETAS



AISI 304	Ref.	-	-	-	-	-	4016050	-	4016051	-	4016052
	€ U.	-	-	-	-	-	-	141,90	-	159,15	-

Ref.	4019984	Unidades de embalaje
€ U.	37,85	Packing units Unités d'emballage

300	350	400	450	500	550	600	650	700
250	300	350	400	450	500	550	600	650
180/300	200/350	250/400						
200	250	300	350	400	450	500	550	600

4019990	4019991	4021062	4033536	4030214	4033537	4033538	4033540	4033542
70,65	93,20	106,55	124,10	143,35	178,75	186,20	206,00	229,55

4019724	4019725	4019726	-	-	-	-	-	-
64,40	84,90	96,95	-	-	-	-	-	-

4011482	4022499	4022500	-	-	-	-	-	-
56,15	65,10	77,50	-	-	-	-	-	-

400	450	500	-	-	-	-	-	-
-----	-----	-----	---	---	---	---	---	---

4017666	4017667	4017668	-	-	-	-	-	-
86,60	102,85	115,85	-	-	-	-	-	-

4019853	4019854	4019855	-	-	-	-	-	-
99,60	118,25	133,25	-	-	-	-	-	-

4017653	4016684	4016685	-	-	-	-	-	-
107,15	127,20	143,10	-	-	-	-	-	-

4016289	4016686	4017665	-	-	-	-	-	-
113,05	134,15	151,05	-	-	-	-	-	-

4017691	4017692	4017693	-	-	-	-	-	-
120,60	143,10	161,10	-	-	-	-	-	-

4018701	4019979	4040444	-	-	-	-	-	-
100,40	111,40	124,95	-	-	-	-	-	-

4016787	4019976	4029518	-	-	-	-	-	-
111,45	123,75	138,80	-	-	-	-	-	-

-	-	-	-	-	-	-	-	-
-	-	-	-	-	-	-	-	-

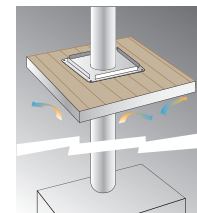
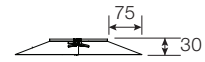
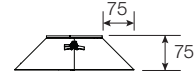

Distanciador fuego  
Firebreak  
Plaque écart au feu

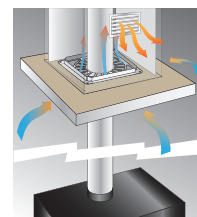

Distanciador fuego ventilado  
Ventilated firebreak  
Plaque écart au feu ventilée

SP - F - BD	Ø	80	100	110	125	130	150	180	200	230	250
DP - EI	Ø					80	100	125 - 130	150	180	200
CC	Ø				80/125	80/130	100/150	110/180	130/200		150/250
DP50	Ø									130	150

Distanciador fuego estanco horizontal 2 piezas | Horizontal sealed firebreak 2 parts | *Plaque écart au feu étanche horizontale 2 pièces*

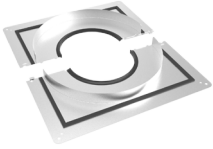

AISI 304	Ref.	-	-	-	-	4025575	4025579	4025580	4025581	4025582	4025583
	€ U.	-	-	-	-	-	160,80	164,80	173,55	182,30	196,60

Distanciador fuego estanco inclinado 1 pieza | Inclined sealed firebreak 1 part | *Plaque écart au feu étanche inclinée 1 pièce*

5° / 25°

AISI 304	Ref.	-	-	-	-	4025644	4025646	4025647	4025648	4025649	4025650
	€ U.	-	-	-	-	-	166,75	170,95	179,90	189,05	203,85

25° / 45°

AISI 304	Ref.	-	-	-	-	4025651	4025652	4025653	4025654	4025662	4025663
	€ U.	-	-	-	-	-	191,75	196,60	206,90	217,40	234,45

45° / 60°

AISI 304	Ref.	-	-	-	-	4025664	4025665	4025666	4025667	4025668	4025669
	€ U.	-	-	-	-	-	210,90	216,20	227,65	239,10	258,00

Embelecedor para distanciador fuego estanco horizontal 2 piezas | Horizontal sealed firebreak sloping roof trim 2 parts |

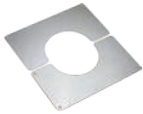

AISI 304	Ref.	-	-	-	-	4025768	4025790	4025792	4025793	4025794	4025795
	€ U.	-	-	-	-	-	88,40	92,10	105,80	110,40	117,25

Embelecedor para distanciador fuego estanco inclinado 2 piezas | Inclined sealed firebreak sloping roof trim 2 parts |

5° / 25°

AISI 304	Ref.	-	-	-	-	4025670	4025671	4025672	4025678	4025679	4025680
	€ U.	-	-	-	-	-	104,55	108,80	125,00	130,45	138,60

25° / 45°

AISI 304	Ref.	-	-	-	-	4025681	4025705	4025706	4025707	4025708	4025709
	€ U.	-	-	-	-	-	114,15	118,10	135,65	140,90	150,40

45° / 60°

AISI 304	Ref.	-	-	-	-	4025710	4025711	4025712	4025713	4025714	4025715
	€ U.	-	-	-	-	-	131,20	135,80	156,00	162,10	172,95

Aislante paso mural | Insulating wall bushing | *Coquille isolante*



L 330	Ref.	-	-	-	-	4026212	4026213	4026214	4026215	4026216	4026217
	€ U.	-	-	-	-	-	89,25	96,55	101,20	104,25	110,40

L 500	Ref.	-	-	-	-	4026218	4026219	4026220	4026221	4026222	4026223
	€ U.	-	-	-	-	-	116,30	124,55	131,45	134,15	141,80

L 660	Ref.	-	-	-	-	4026224	4026225	4026226	4026227	4026228	4026229
	€ U.	-	-	-	-	-	150,30	161,70	171,40	174,10	179,10



Ref.	4025579	Unidades de embalaje
€ U.	164,80 <sup>1</sup>	Packing units Unités d'emballage

300	350	400	450	500	550	600	650	700
250	300	350	400	450	500	550	600	650
180/300	200/350	250/400						
200	250	300	350	400	450	500	550	600

4034286	-	-	-	-	-	-	-	-
239,80 <sup>1</sup>	-	-	-	-	-	-	-	-

4034283	-	-	-	-	-	-	-	-
239,40 <sup>1</sup>	-	-	-	-	-	-	-	-

4034284	-	-	-	-	-	-	-	-
275,30 <sup>1</sup>	-	-	-	-	-	-	-	-

4034285	-	-	-	-	-	-	-	-
302,80 <sup>1</sup>	-	-	-	-	-	-	-	-

Plaque de finition pour plaque écart au feu étanche horizontale 2 pièces

4025796	-	-	-	-	-	-	-	-
129,35 <sup>1</sup>	-	-	-	-	-	-	-	-

Plaque de finition pour plaque écart au feu étanche inclinée 2 pièces

4025682	-	-	-	-	-	-	-	-
152,60 <sup>1</sup>	-	-	-	-	-	-	-	-

4025740	-	-	-	-	-	-	-	-
165,90 <sup>1</sup>	-	-	-	-	-	-	-	-

4025741	-	-	-	-	-	-	-	-
187,75 <sup>1</sup>	-	-	-	-	-	-	-	-

4025977	4040050	-	-	-	-	-	-	-
130,15 <sup>1</sup>	149,65 <sup>1</sup>	-	-	-	-	-	-	-

4025980	4040051	-	-	-	-	-	-	-
170,40 <sup>1</sup>	196,00 <sup>1</sup>	-	-	-	-	-	-	-

4025982	4040052	-	-	-	-	-	-	-
203,30 <sup>1</sup>	242,75 <sup>1</sup>	-	-	-	-	-	-	-

Montaje / Assembly / Montage

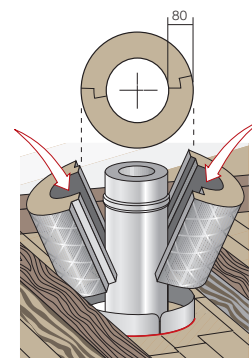
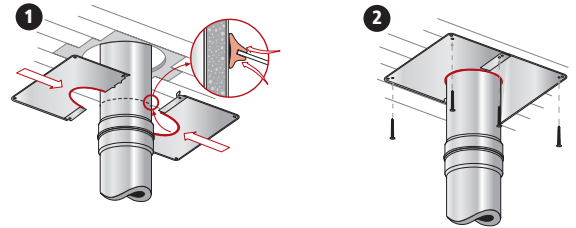

### Puerta limpia | Cleaning door | *Trappe de ramonage*



Empotrable 14 x 20  
Recessed 14 x 20  
Encastrable 14 x 20

AISI	Ref.	5003920
<b>304</b>	€ U.	<b>77,00</b> 1



Con cajón empotrable 250mm  
With recessed drawer 250mm  
Avec boîtier encastrable 250mm

AISI	Ref.	5003919
<b>304</b>	€ U.	<b>127,35</b> 1



Puerta de ventilación  
Ventilation door  
*Trappe de ventilation*

AISI	Ref.	5003913
<b>304</b>	€ U.	<b>70,50</b> 1

### Kit salida a techo + módulo DP | Rooftop kit + DW module | *Kit Sortie de toit + élément droit DP*

**RAL 1015**



	Ø	130	150	180	200	250
GALVA	Ref.	4025989	4025990	4025994	4025995	4025996
	€ U.	<b>942,10</b> 1	<b>946,25</b> 1	<b>954,55</b> 1	<b>959,45</b> 1	<b>971,35</b> 1

**RAL 9005**



	Ø	130	150	180	200	250
GALVA	Ref.	4026000	4026001	4026002	4026003	4026004
	€ U.	<b>942,10</b> 1	<b>946,25</b> 1	<b>954,55</b> 1	<b>959,45</b> 1	<b>971,35</b> 1

**RAL 7016**



	Ø	130	150	180	200	250
GALVA	Ref.	4026005	4026007	4026008	4026010	4026011
	€ U.	<b>942,10</b> 1	<b>946,25</b> 1	<b>954,55</b> 1	<b>959,45</b> 1	<b>971,35</b> 1

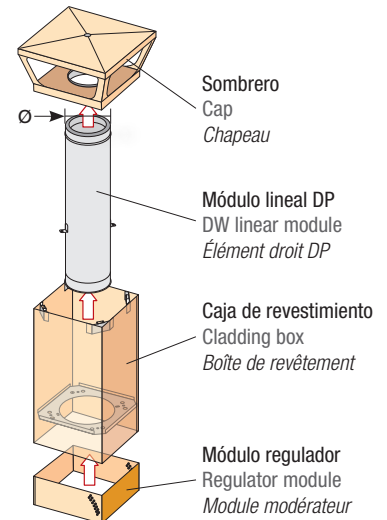

Otro color RAL | Other RAL colour | *Autre couleur RAL*



	Ø	130	150	180	200	250
GALVA	Ref.	4026012	4026014	4026015	4026016	4026017
	€ U.	<b>1.036,30</b> 1	<b>1.040,85</b> 1	<b>1.050,05</b> 1	<b>1.055,30</b> 1	<b>1.068,45</b> 1

### Base estanca salida a techo | Sealed rooftop base | *Embase étanche sortie de toit*

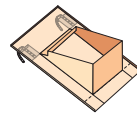

5°/25°

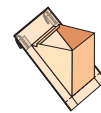

25°/45°

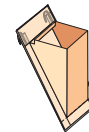

45°/60°

**RAL 1015**



GALVA	Ref.	4026018	4026019	4026020
	€ U.	<b>325,45</b> 1	<b>369,80</b> 1	<b>391,05</b> 1

**RAL 9005**



GALVA	Ref.	4026024	4026025	4026026
	€ U.	<b>325,45</b> 1	<b>369,80</b> 1	<b>391,05</b> 1

**RAL 7016**



GALVA	Ref.	4026021	4026022	4026023
	€ U.	<b>325,45</b> 1	<b>369,80</b> 1	<b>391,05</b> 1

Otro color RAL | Other RAL colour | *Autre couleur RAL*



GALVA	Ref.	4026027	4026029	4026030
	€ U.	<b>357,95</b> 1	<b>406,85</b> 1	<b>430,10</b> 1

Ref.	4025990	Unidades de embalaje
€ U.	946,25	Packing units
		Unités d'emballage

Kit salida a techo conducto en espera | Rooftop kit piping pending | Kit sortie de toit conduit en attente

RAL 1015



GALVA	Ref.	4025984
	€ U.	825,50 1

RAL 7016



GALVA	Ref.	4025986
	€ U.	825,50 1

RAL 9005



GALVA	Ref.	4025987
	€ U.	825,50 1

Otro color RAL | Other RAL colour | Autre couleur RAL



GALVA	Ref.	4025988
	€ U.	908,05 1

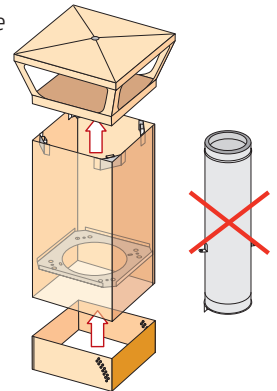

Kit de fijación | Fixing kit | Kit de fixation \*



AISI 304	Ref.	4026036
	€ U.	103,40 1

Kit salida a techo con base estanca inclinada + kit de fijación  
Rooftop kit with sealed base + fixing kit  
Kit sortie de toit avec embase étanche + kit de fixation

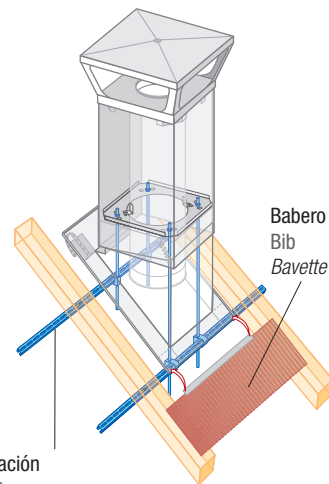

\* Kit de fijación  
Fixing kit  
Kit de fixation

10

Kit tapa ciega | Blind cap kit | Kit conduit à l'attente tampon plein



	RAL 9002	RAL 9011
Ref.	4025808	4025803
€ U.	201,20 1	201,20 1

Kit tapa recortable | Cut out cap kit | Kit conduit à l'attente tampon recoupable



2

	RAL 9002	RAL 9011
Ref.	4025809	4025804
€ U.	238,15 1	238,15 1

Tapa ciega | Blind cap | Tampon plein



	RAL 9002	RAL 9011
Ref.	4025806	4025801
€ U.	146,40 1	146,40 1

Tapa recortable | Cut out cap | Tampon recoupable



2

	RAL 9002	RAL 9011
Ref.	4025807	4025802
€ U.	172,70 1	172,70 1

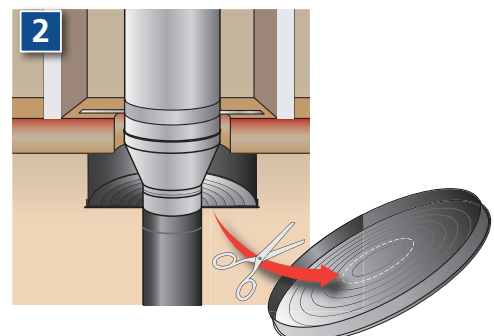
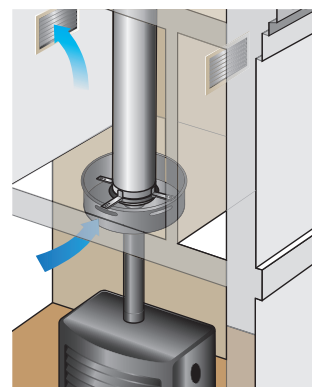

# 11 CP

Conducto de polipropileno  
Polypropylene piping  
*Conduit de polypropylène*

Ø 60 - 100

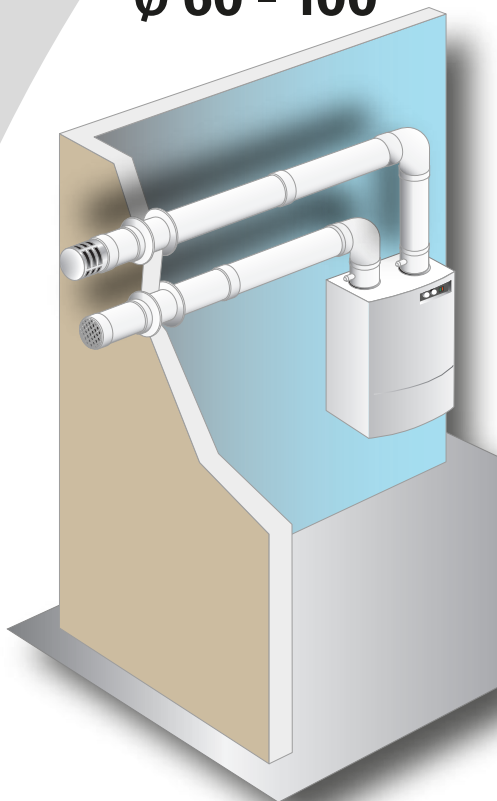

**CONDUCTO RÍGIDO BIFLUJO SIMPLE**  
**SINGLE RIGID BIFLOW DUCT**  
*CONDUIT RIGIDE BIFLUX SIMPLE*

Ø 60 - 200

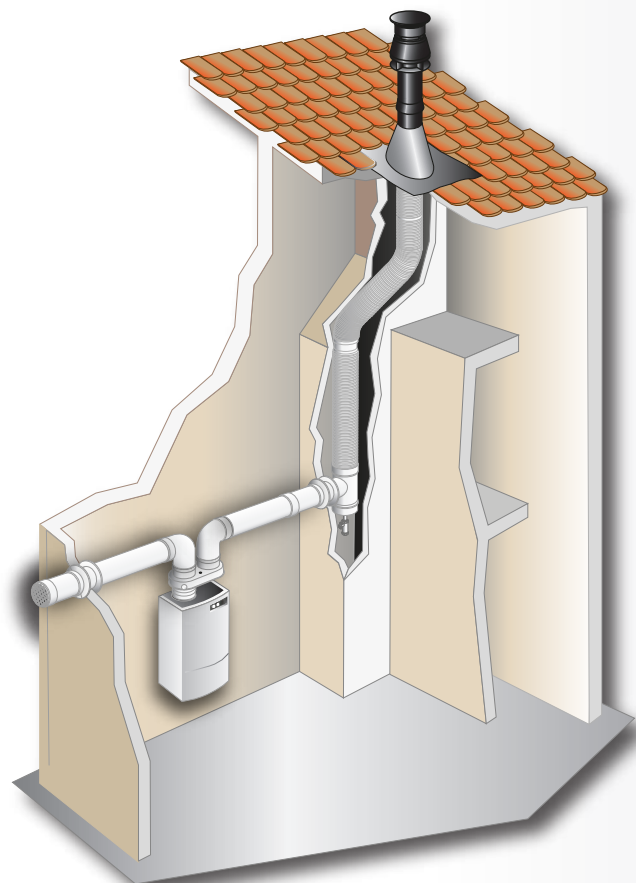

**CONDUCTO FLEXIBLE BIFLUJO SIMPLE**  
**SINGLE BIFLOW FLEXIBLE DUCT**  
*CONDUIT FLEXIBLE BIFLUX SIMPLE*



Ø 60/100 - 100/150

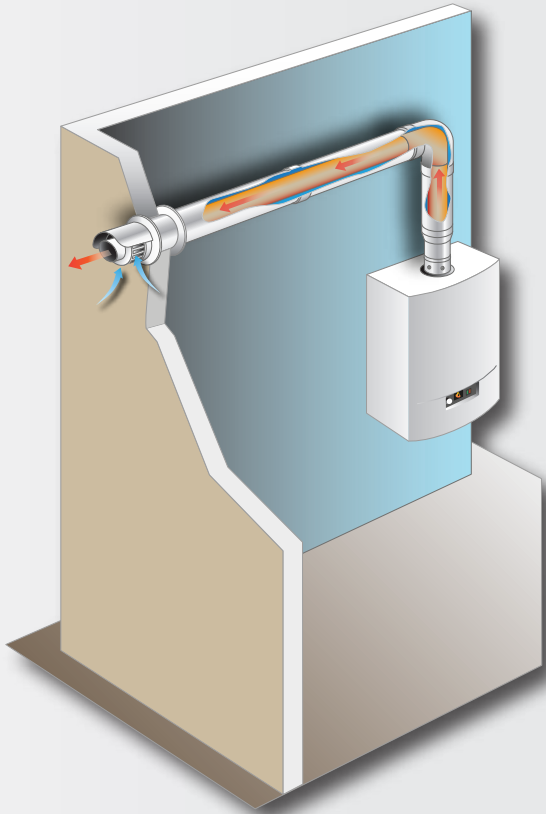

**CONDUCTO COAXIAL**  
COAXIAL DUCT  
CONDUIT COAXIAL

Ø 110 - 300

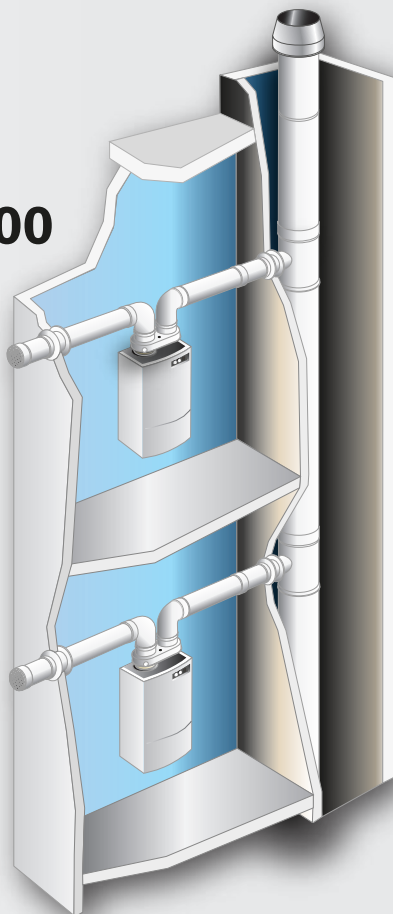

**CONDUCTO RÍGIDO SIMPLE, CASCADA, BIFLUJO**  
SINGLE RIGID DUCT, AS CASCADE, BIFLOW  
CONDUIT RIGIDE SIMPLE, EN CASCADE, BIFLUX

**CE** Especificaciones de acuerdo a la legislación europea en productos de construcción **CPR**  
Specifications according to EU product regulations of construction **CPR**  
Spécifications Selon la réglementation européenne concernant les produits de construction **CPR**

Espeor  
Thickness  
Épaisseur

1,5 mm (min.)

Color  
Colour  
Couleur



Blanco | White | Blanc



**CONDUCTO RÍGIDO BIFLUJO SIMPLE**  
SINGLE RIGID BIFLOW DUCT  
CONDUIT RIGIDE BIFLUX SIMPLE

PP Ø60 - 100

UNE-EN 14471

T120 H1 W 2 O20 LI E U

**CONDUCTO FLEXIBLE BIFLUJO SIMPLE**  
SINGLE BIFLOW FLEXIBLE DUCT  
CONDUIT FLEXIBLE BIFLUX SIMPLE

PP Ø60 - 200

UNE-EN 14471

T120 H1 W 2 O20 LI E U

**CONDUCTO COAXIAL**  
COAXIAL DUCT  
CONDUIT COAXIAL

interior | inside | intérieur

PP

exterior | outside | extérieur

Ø60/100 - 100/150

STEEL

Acero galvanizado lacado  
Galvanized painted steel  
Acier galvanisé lacqué

UNE-EN 14471

T120 H1 W 2 O00 LI E U0

**CONDUCTO RÍGIDO SIMPLE, CASCADA, BIFLUJO**  
SINGLE RIGID DUCT, AS CASCADE, BIFLOW  
CONDUIT RIGIDE SIMPLE, EN CASCADE, BIFLUX

PP Ø110 - 300

UNE-EN 14471

T120 H1 W 2 O20 LI E U

**Nota: | Note:**

Respetar inclinación mínima de 3° (5,2%) ascendente en instalaciones horizontales de conductos de evacuación de humos en polipropileno para aparatos a condensación. (Norma EN 123001:2009, Apdo 5.5.1)

Respect a minimum 3° (5,2%) ascendent inclination for horizontal installations of flue piping made with polypropylene for condensation boilers. (Norm EN 123001:2009, Apdo 5.5.1)

Respectez l'inclinaison minimale de 3° (5,2%) dans les installations horizontales de conduits d'évacuation des fumées en polypropylène pour les appareils à condensation. (Norme EN 123001:2009, Apdo 5.5.1)

\* Consulte al Departamento Comercial para más información  
Consult Sales Department for more information  
Contactez le Service Commercial pour plus d'informations

## DECLARACIÓN DE CONFORMIDAD E INFORMACIÓN DEL PRODUCTO DECLARATION OF CONFORMITY AND PRODUCT INFORMATION DÉCLARATION DE CONFORMITÉ ET INFORMATION SUR LE PRODUIT

**NOTA:** Para diámetros superiores a 300 mm, la distancia a los materiales combustibles se debe incrementar mediante un coeficiente.

**NOTE:** For diameters bigger than 300 mm, the distance to combustible materials must be increased by a coefficient.

**REMARQUE:** Pour les diamètres supérieurs à 300 mm, la distance par rapport aux matériaux combustibles doit être augmentée par un coefficient.

Incremento Increase Augmentation	Ø Diámetros Ø Diameters Ø Diamètres
x 1,5	350 - 450
x 2,0	500 - 600
x 4,0	650 - 700

T300	N1	W	V2	L50040	O(20)
------	----	---	----	--------	-------

Temperatura de trabajo  
Operating temperature  
Température de travail

Estanqueidad al gas  
Gas tightness  
Étanchéité au gaz

Resistencia a los condensados  
Condensation resistance  
Résistance à la condensation

Resistencia a la corrosión  
Rust resistance  
Résistance à la rouille

Material pared interior  
Inner wall material  
Matériel paroi intérieure

Grosor pared interior  
Inner wall thickness  
Épaisseur de paroi intérieure

Resistencia a la ignición del hollín (G: sí; O: no)  
Soot ignition resistance (G: yes; O: no)  
Résistance à l'inflammation de la suie (G: oui; O: non)

Distancia material combustible  
Distance to combustible material  
Distance matériel combustible

## UNIDADES DE JUNTAS POR ELEMENTO | GASKET UNITS PER ELEMENT | UNITÉS DE JOINTS PAR ÉLÉMENT



JUNTAS POR ELEMENTO   GASKETS PER ELEMENT   JOINTS PAR ÉLÉMENT	UNIDADES   UNITS   UNITÉS	
Elementos conductores (módulos lineales, codos, etc.) Smoke piping (linear modules, elbows, etc.) Conduits de fumée (éléments droits, coudes, etc.)	1	
Tes   "T" pieces   Tés	2	
Módulos extensibles   Extendable modules   Éléments télescopiques	2	
Módulo de limpieza oval   Oval cleaning module   Module ramonage ovale	1	(*)
Paso mural extensible   Extendable wall bushing   Traversée de mur télescopique	1	
Paso mural normal   Standard wall bushing   Traversée de mur normale	0	
Adaptador caldera   Boiler adapter   Adaptateur chaudière	0	

(\*) 1 x 5003952 adicional para la puerta de limpieza | additional for cleaning door | supplémentaire pour la trappe de ramonage

ESCUADRAS - TABLAS DE DISTANCIAS | SQUARES - DISTANCE TABLES | ÉQUERRES - TABLEAU DE DISTANCES

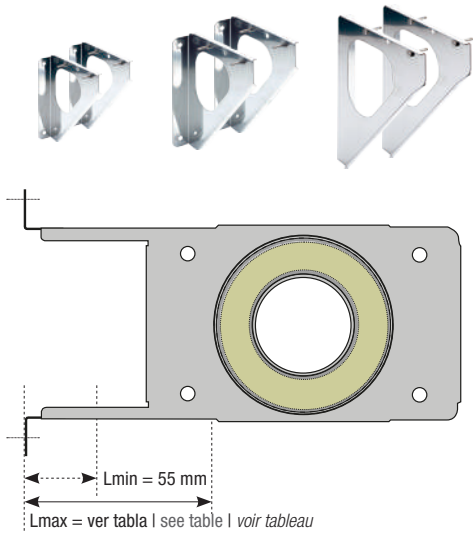

Ø Tubo exterior (mm) Ø External pipe (mm) Ø Conduit extérieure (mm)	Lmax (mm)					
	Escuadra   Square   Équerre		Escuadra   Square   Équerre		Escuadra   Square   Équerre	
	pequeña   small   petit	mediana   medium   moyen	mediana   medium   moyen	grande   large   grand	grande   large   grand	grande   large   grand
	<b>4019925</b>	<b>4019926</b>	<b>4019926</b>	<b>4019927</b>	<b>4019927</b>	<b>4019927</b>
80	150	250	250	-	-	-
100	150	250	250	-	-	-
110	150	250	250	-	-	-
125	150	250	250	-	-	-
130	150	250	250	-	-	-
150	150	250	250	-	-	-
180	-	150	250	250	250	250
200	-	150	250	250	250	250
230	-	150	250	250	250	250
250	-	150	250	250	250	250
300	-	-	-	150	150	150
350	-	-	-	150	150	150
400	-	-	-	150	150	150

CONFIGURACIONES ABRAZADERA FORJADO UNIVERSAL  
CONFIGURATIONS FOR THE UNIVERSAL CEILING BRACKET  
POSSIBILITÉS DE MONTAGE DU SUPPORT PLANCHER UNIVERSEL

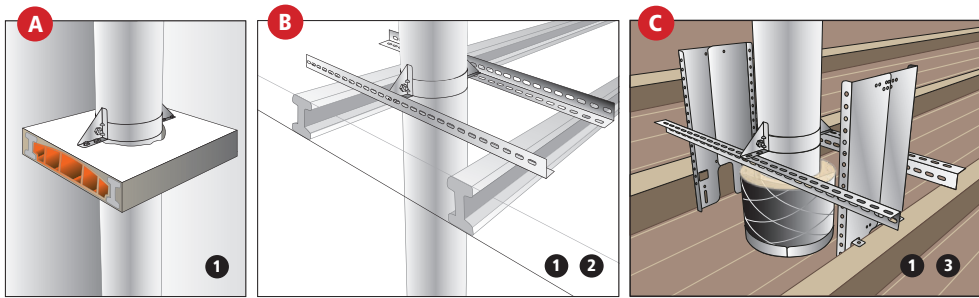

- 1 Abrazadera forjado universal  
Universal ceiling bracket  
Collier support plancher universel
- 2 Fijación forjado angular (2 unidades)  
Angular forged fixation (2 units)  
Fixation angulaire (2 unités)
- 3 Kit prolongación forjado  
Forged extension kit  
Kit extension étage

CONDICIONES RAL | RAL CONDITIONS | CONDITIONS RAL

Pintura Senotherm - Garantizada hasta temperaturas de 600° C  
Senotherm paintwork - Guaranteed up to temperatures of 600° C  
Peinture Senotherm - Garantie pour températures jusqu'à 600° C

Simple pared   Single wall   Simple paroi 304	35%	290 €
Simple pared   Single wall   Simple paroi 316L	30%	360 €

RAL 9011 NEGRO MATE HT (600° C) Artículos estándar RAL 9011 MATT BLACK HT (600° C) Standard items RAL 9011 NOIR MAT HT (600° C) Articles standard	
Suplemento Surcharge Supplément	Pedido mínimo RAL RAL minimum order Commande minimale par RAL
35%	290 €
30%	360 €



Color según gama RAL 250° C Colour according to RAL 250° C range Couleur selon nuancier RAL 250° C		
Doble pared   Double wall   Double paroi 316L / 304	25%	700 €
Doble pared   Double wall   Double paroi 304 / 304	30%	600 €
Concéntrico   Concentric   Concentrique 316L / 304	25%	700 €
Concéntrico   Concentric   Concentrique 304 / 304	30%	600 €

Color según gama RAL 250° C Colour according to RAL 250° C range Couleur selon nuancier RAL 250° C	
Suplemento Surcharge Supplément	Pedido mínimo RAL RAL minimum order Commande minimale par RAL
25%	700 €
30%	600 €
25%	700 €
30%	600 €

- Pintura Epoxy en polvo.
- Llámennos para confirmar vuestro color RAL.
- El plazo de entrega para todos nuestros productos RAL es de 15 días laborables.
- Para pedidos inferiores al pedido mínimo, se aplicará un suplemento de 117,40 €.
- Para cualquier información adicional, contacte con nosotros.
- \* Carta de colores según disponibilidad.

- Epoxy powder coating.
- Call us to confirm your RAL colour.
- The delivery time for all our RAL products is 15 working days.
- For orders below the minimum order, a surcharge of 117,40€ will be applied.
- For any additional information, please contact us.
- \* Colour chart subject to availability.

- Peinture époxy en poudre.
- Contactez-nous pour confirmer votre couleur RAL.
- Le délai de livraison par tous nos produits RAL est de 15 jours ouvrés.
- Pour commandes inférieures à la commande minimale, nous appliquons un supplément de 117,40€.
- Pour tout complément d'informations, veuillez nous contacter.
- \* Nuancier selon disponibilité.

**CÓMO FIJAR LA INSTALACIÓN DOBLE PARED A LA PARED: DISTANCIAS Y ALTURAS**  
**HOW TO FIX THE DOUBLE WALL INSTALLATION TO THE WALL: DISTANCES AND HEIGHTS**  
**COMMENT FIXER L'INSTALLATION DOUBLE PAROI AU MUR: DISTANCES ET HAUTEURS**

# 1 DP

## Doble Pared | Double Wall | Double Paroi

**A Distancias máximas entre abrazaderas murales exteriores.**

Maximum distances between external wall brackets.  
*Distances maximales entre colliers support mural extérieures.*

**B Altura libre por encima de la última.**

Free height above the last one.  
*Hauteur libre au dessus du dernier.*

**C Carga máxima: alturas máximas encima del soporte mural intermedio.**

Maximum load: maximum heights above the intermediate wall support.  
*Charge maximale: hauteurs maximales au dessus du support mural.*

**D Carga máxima: alturas máximas encima de la Te.**

Maximum load: maximum heights above the "T" piece.  
*Charge maximale: hauteurs maximales au dessus du Té.*

**E Resistencia a la tracción: alturas máximas en caso de montaje suspendido.**

Tensile strength: maximum heights in case of suspended assembly.  
*Résistance à la traction: hauteurs maximales en cas d'assemblage suspendu.*

øD	A	B			C	D	E
		B1	B2	B3			
80	4m	2m	2,5m	3m	42m	24m	15m
100	4m	2m	2,5m	3m	34m	20m	12m
125	4m	2m	2,5m	3m	27m	18m	10m
130	4m	2m	2,5m	3m	26m	17m	10m
150	4m	2m	2,5m	3m	22m	16m	9m
180	4m	2m	2,5m	3m	22m	14m	8m
200	4m	2m	2,5m	3m	20m	13m	7m
250	4m	2m	2,5m	3m	14m	13m	6m
300	4m	2m	2,5m	3m	13m	12m	5m
350	4m	2m	2,5m	3m	13m	12m	4m

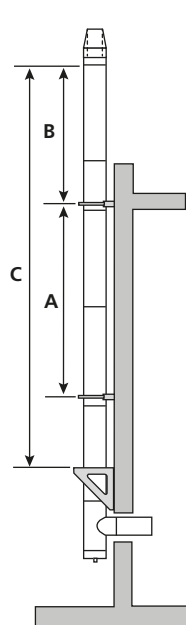

**Las abrazaderas murales exteriores deben instalarse lo más cerca posible de los puntos de unión de ambos elementos.**

External wall brackets must be installed as near as possible to the junction points of the two elements.

*Les colliers support mural extérieures doivent être montés le plus proche possible aux points de la jonction des deux éléments.*

**Siempre se debe instalar un soporte de pared intermedio después de una Te.**

An intermediate wall support must be always installed after a "T" piece.

*Après un té il faut toujours monter un support mural intermédiaire.*

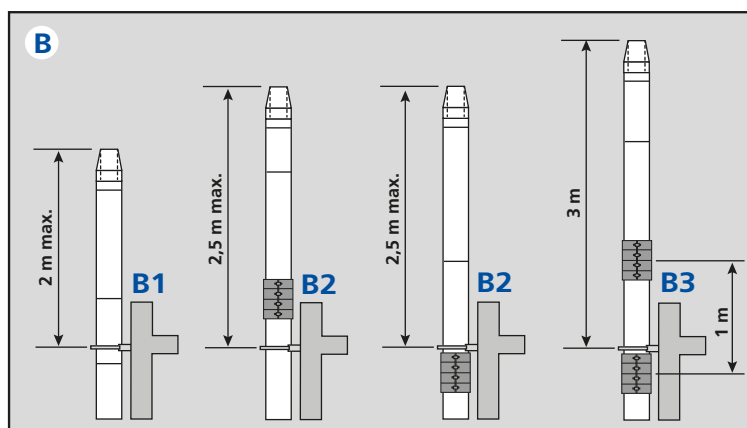
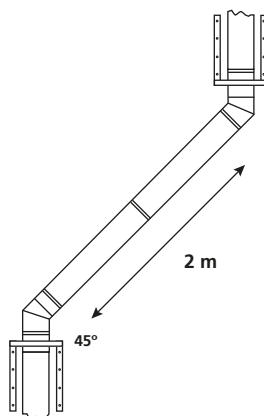
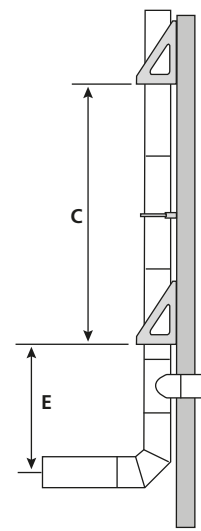
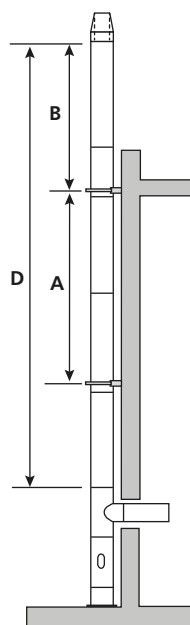

\* Consultar la normativa del país donde se realice la instalación.  
 \* Consult the regulations of the country where the installation is carried out.  
 \* Consultez les réglementations du pays où l'installation est effectuée.



# 4 EI

Resistencia al fuego EI | Fire resistance EI | Résistance au feu EI

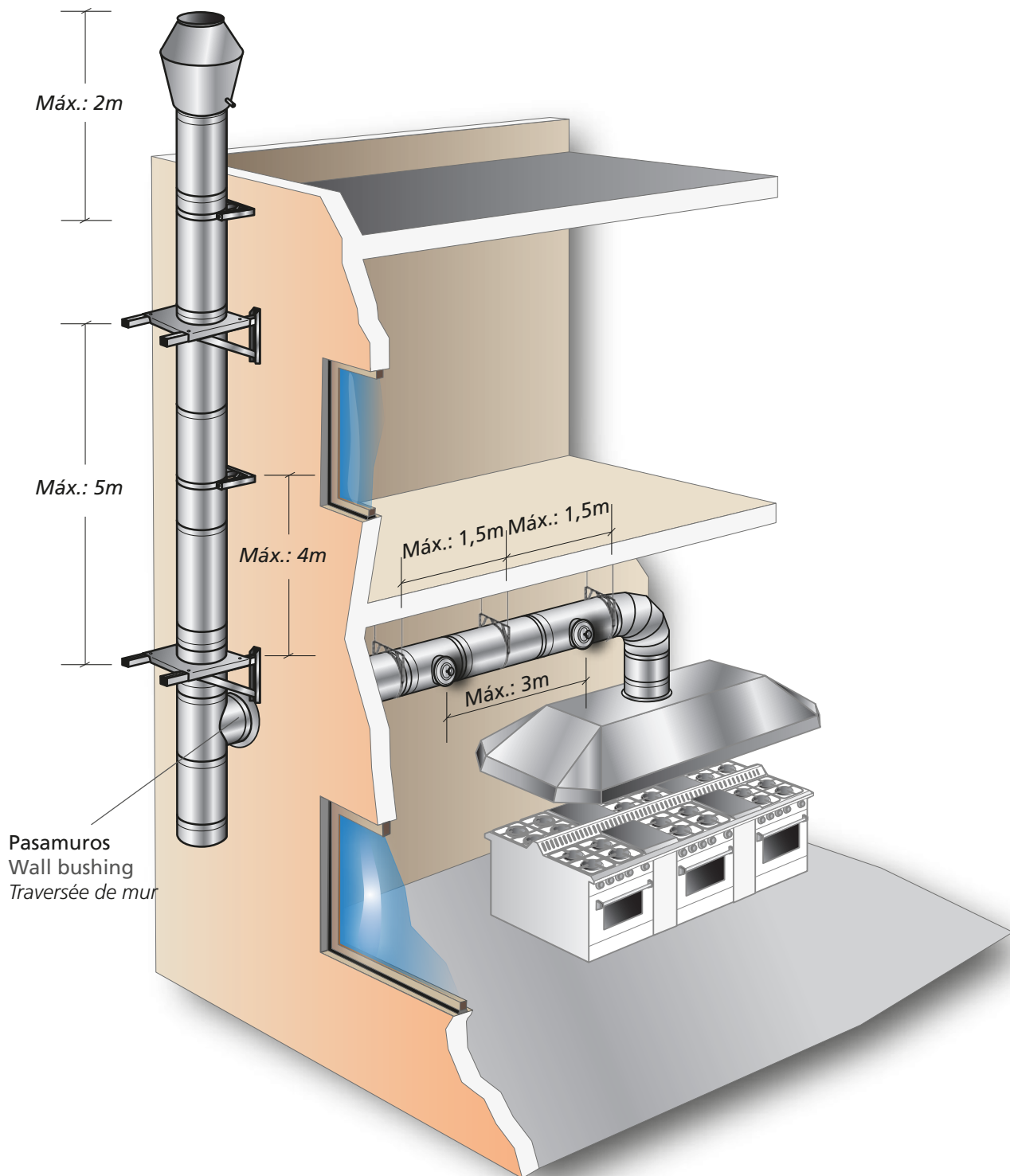

# CONDICIONES GENERALES DE VENTA

## 1. Generalidades y ámbito de aplicación

1. Nuestras condiciones generales de pago y entrega se aplican a empresas a efectos del at 1 Código de Comercio (22/8/1885) y Ley 7/1998 de 13 de abril. A este efecto, se entenderá por empresario toda persona física o jurídica o sociedades personalizadas con capacidad de obrar con las que se establezca una relación comercial y que ejerza una actividad profesional comercial o por cuenta propia.
2. Las siguientes condiciones serán aplicables a todas nuestras ofertas y entregas. Se aplicarán a todas las relaciones comerciales presentes y futuras, aunque no hayan sido acordadas de nuevo explícitamente.
3. Las condiciones de compra del cliente no formarán parte del contrato. Tampoco serán aceptadas si, tras su recepción, nos opusieramos explícitamente. Nuestras condiciones generales de pago y entrega se considerarán aceptadas a más tardar con la recepción de la mercancía y servicios suministrados por nosotros. Las variaciones de estas condiciones sólo serán válidas si se pactan por escrito.
4. Los derechos derivados de este acuerdo serán intransferibles.

## 2. Garantías del contrato

1. Todas nuestras ofertas, formuladas por escrito u oralmente, quedan sujetas a confirmación y no tendrán carácter vinculante, es decir, no comprometen a efectuar la entrega. Con la confirmación de pedido, el cliente declara de forma vinculante querer adquirir los artículos pedidos o querer hacer el pedido. Nos reservamos el derecho de aceptar la oferta contractual incluida en el pedido en el plazo de dos (2) semanas tras su recepción. La aceptación será manifestada al cliente por escrito o mediante el suministro de la mercancía. Únicamente se considerará determinante, para el alcance del servicio debido por contrato, nuestra confirmación de pedido.
2. Los acuerdos con representantes son vinculantes para el cliente, pero sólo serán válidos si han sido confirmados por escrito por nosotros.
3. Nos reservamos los derechos de propiedad y de autor sobre la documentación correspondiente a la oferta. Esta documentación no podrá ser transferida a terceros sin nuestro consentimiento previo. En caso de no efectuarse el pedido, la documentación deberá sernos devuelta en caso de que así lo requiramos y destruida. Los precios de cada una de las posiciones de la oferta sólo tendrán validez al hacer el pedido completo de la presente oferta. Los diseños, ilustraciones, medidas, pesos u otros datos referidos a nuestros servicios sólo serán vinculantes si así se acuerda expresamente por escrito.
4. Si el cliente realiza el pedido de la mercancía por vía electrónica, procederemos de manera inmediata a la confirmación del pedido. Esta confirmación de recepción no representa una aceptación vinculante. La confirmación de recepción se puede vincular con una declaración de aceptación. Si el consumidor realiza el pedido de la mercancía por vía electrónica, guardaremos el texto del contrato, y, si lo requiriese, se le enviaría por correo electrónico al cliente junto con las presentes condiciones.
5. Nos reservamos el derecho de efectuar modificaciones en el diseño, selección de materiales, especificaciones y tipo de construcción, incluso después de haber enviado la confirmación del pedido, siempre que estas modificaciones no sean incompatibles, ni con la confirmación del pedido, ni con las especificaciones del cliente. El cliente manifestará su conformidad con las modificaciones propuestas, siempre que éstas sean razonables para él.

## 3. Tolerancias

Las tolerancias se determinan para el cumplimiento de las características dimensionales de nuestros productos. A menos que como proveedor no notifiquemos expresamente lo contrario, fabricamos de acuerdo con nuestras tolerancias estándar.

## 4. Precios

1. Nuestros precios se desprenden de la confirmación de pedido. Nuestros precios son en euros unidad y con la mercancía situada en nuestros almacenes de Sant Jaume de Llierca (Girona) (España), sin incluir embalaje, gastos de envío y de transporte, así como libres de derechos arancelarios (extranjero).
2. Si entre la firma del contrato y la entrega o servicio, se incrementasen los precios de nuestros proveedores, nuestros costes (tales como, aumento de los precios de flete, aumentos salariales o del precio de las materias primas) o nuestros impuestos, o se introdujesen otros nuevos, tenemos derecho a incrementar en consecuencia el precio, a no ser que el precio haya sido expresamente fijado.
3. En caso de tomar en consideración propuestas de modificación del cliente, tendremos derecho a facturar al cliente los costes adicionales resultantes.
4. El IVA se facturará en función de las disposiciones legales. Cualquier aumento del tipo del IVA que tenga lugar entre el pedido y la entrega correrá a cargo del cliente.

## 5. Condiciones de pago

1. El pago de nuestros suministros se realizará, sin ninguna deducción, dentro de los TREINTA (30) días naturales siguientes a su recepción. Transcurrido este plazo, el cliente incurre en demora de pago.
2. Además de un acuerdo individual expreso, se requerirá como condición adicional para la concesión de descuentos que todas las facturas anteriores a la fecha se hayan liquidado. Para el cálculo del descuento será determinante el importe neto de la factura, una vez deducidos descuentos, flete y otros gastos que repercutan a terceros.
3. No estamos obligados a aceptar letras de cambio, pagarés, cheques o confirming. Sólo aceptaremos letras de cambio sujetas a una posibilidad de descuento. Los cheques, pagarés y letras de cambio se acreditarán una vez que se hayan cobrado en efectivo. En el caso de cesión de créditos una vez que se hayan abonado. Hasta entonces, la deuda y su fecha de vencimiento no sufrirá modificaciones. No asumimos responsabilidad alguna por la presentación y el protesto puntuales. La gestión del protesto y las comisiones de cobro correrán a cargo del cliente.
4. Aunque las disposiciones del comprador sostengan lo contrario, nos asistirá el derecho a cargar los pagos adeudados y contraídos por el cliente con anterioridad, en orden de antigüedad.
5. El cliente no está autorizado a retrasar ningún pago o a compensarlo mediante contra reclamaciones impugnadas por nosotros.
6. En caso de incumplimiento de las condiciones de pago por parte del cliente (deudor), todas

las deudas pendientes serán exigibles inmediatamente. La demora en el pago por parte del cliente tendrá como consecuencia la retención del suministro con arreglo a las disposiciones adoptadas en el punto 5.

## 6. Morsidad e insolvencia

1. En caso de incumplimiento de los plazos de pago establecidos (demora) o en el caso de notificación de protesto de un cheque, pagaré y/o letra de cambio, tenemos derecho a:
  - rescindir todos los contratos y reclamar daños y perjuicios por incumplimiento;
  - hacer cumplir nuestra reserva de dominio y tomar posesión de la mercancía suministrada (véase punto 10);
  - exigir garantías y liquidar las garantías recibidas;
  - declarar vencidos todos los pagos pendientes y efectuar las entregas pendientes contra pago anticipado;
  - cargar intereses de demora a partir de la fecha de vencimiento por un total del ocho por ciento sobre el tipo de interés básico establecido por el Banco Central Europeo más los intereses de demora del IVA devengado vigente en el momento;
  - cargar cualquier posible daño de demora tras presentar las correspondientes pruebas al cliente.

2. En caso de procedimiento judicial o en caso de iniciación de los procedimientos de insolvencia sobre el patrimonio del cliente, no tendrán validez las rebajas, bonificaciones y descuentos concedidos de las facturas pendientes de pago.

## 7. Plazos de entrega

1. Los pedidos recibidos se considerarán aceptados una vez que los hayamos confirmado por escrito. Los plazos y fechas de entrega sólo son aproximados (y pueden estar sujetos al incumplimiento de pagos en curso anteriores). Las fechas y plazos de entrega, que se estipulen con o sin carácter vinculante, se deberán acordar por escrito.
2. Los plazos de entrega acordados sin precisar una determinada fecha de entrega comenzarán con la fecha de nuestra confirmación de pedido. Se considerará que se han respetado los plazos y fechas de entrega si, antes de que el plazo expire, la mercancía sale del lugar de expedición o se notifica que está lista para el envío.
3. A pesar de nuestros derechos por demora del cliente, los plazos y fechas de entrega se prorrogarán por el período de tiempo que el cliente esté en mora con sus obligaciones derivadas del presente u otro acuerdo.
4. En caso de que incurriésemos en demora de entrega, el cliente puede rescindir el contrato una vez que haya expirado el plazo de gracia fijado por él, o puede pedir daños y perjuicios en caso de constatación de daños en los que concurren dolo o negligencia grave por nuestra parte, limitándose, no obstante, a costes adicionales por efectuar una compra de cobertura. No se aplican otros derechos. Queda especialmente excluida la responsabilidad por negligencia leve. La limitación de responsabilidad por negligencia leve no se aplicará en caso de daños físicos y daños para la salud imputables a nosotros, o en caso de fallecimiento del cliente.
5. Se entiende que podrán realizarse entregas parciales, a no ser que se excluya expresamente y por escrito. Para el pago de entregas parciales, se aplicará el punto 4 de las presentes condiciones generales de pago y entrega.

## 8. Condiciones de envío

1. Los riesgos por pérdida o deterioro casual de la mercancía pasarán con la entrega de la mercancía al cliente. En caso de envío, pasarán con la entrega del producto al expedidor, al transportista o a la persona o agencia encargada de realizar el envío. El envío se realiza principalmente ex fábrica, en tanto no se haya acordado otra cosa.
2. Si se acuerda entrega gratuita, los riesgos por pérdida o deterioro casual de la mercancía/objeto vendido pasará con la llegada del vehículo frente a la dirección de entrega, a la planta baja o a un lugar que sea razonablemente accesible con el vehículo. Nuestro cliente estará obligado, en la medida que sea técnicamente posible, a proporcionar empleados o los equipos necesarios para la descarga.
3. Se plantearían las mismas consecuencias si el cliente estuviese en mora de aceptación.
4. Si la mercancía estuviese lista para su envío y se retrasase la recepción o el envío por motivos no imputables a nosotros, los riesgos pasarán al cliente con la recepción de la notificación de la disponibilidad de envío. Los suministros listos para su envío deben ser aceptados inmediatamente a más tardar en un plazo de cinco (5) días hábiles a partir de la fecha de notificación de la disponibilidad de envío. De lo contrario, tenemos derecho a enviar el material según nuestro criterio. Si la carga o el transporte de la mercancía se retrasase por motivos no imputables a nosotros, tenemos el derecho pero no la obligación de almacenar, según nuestro criterio, la mercancía por cuenta y riesgo del comprador y con exclusión de nuestra responsabilidad, y de cargar al cliente los costes derivados, tomar todas las medidas que consideremos oportunas para la conservación de la mercancía y a facturar la mercancía como entregada.
5. Si no hay indicaciones específicas para el envío, este se realizará, según nuestro criterio pero sin nuestra responsabilidad, por el método de envío más barato. Tenemos derecho a suscribir un seguro de transporte y de rotura de mercancías que correrá a cargo del cliente. En el plazo de dos semanas se deberán notificar las reclamaciones por daños, y confirmar por escrito aportando evidencias de la naturaleza y alcance de los daños. Esta responsabilidad pasará al cliente con la entrega de la mercancía al expedidor o transportista, y a más tardar con su salida de fábrica o del almacén. Esto también se aplicará si la entrega se realizase con nuestros propios vehículos.
6. La devolución de la mercancía suministrada por nosotros se realizará a portes pagados sólo si se encuentra en perfecto estado o si hay un acuerdo previo. Si se admite voluntariamente la devolución de la mercancía, ésta se acreditará en función de su estado menos una parte del coste de al menos el Cincuenta por ciento (50%) del valor de la mercancía devuelta. El crédito se realizará tras la recepción

y comprobación de la mercancía en nuestras instalaciones. Se excluye la devolución de ejecuciones especiales o mercancías suministradas especialmente de acuerdo con las especificaciones del cliente.

#### 9. Responsabilidad por defectos

Ofrecemos una garantía contra mercancía defectuosa, incluida la falta de calidad garantizada de acuerdo con las siguientes especificaciones:

1. Nuestra garantía se refiere a una ejecución y uso adecuados de materiales en buen estado. No se asumirá ninguna garantía por daños causados por desgaste natural, carga excesiva y una instalación inadecuada.
2. Una vez que el cliente ha recibido la entrega de la mercancía en la forma prescrita en el contrato, quedará excluido el derecho a dar aviso de cualquier defecto que pudiera haber sido descubierto durante el proceso de entrega estipulado en el contrato.
3. Para las legítimas reclamaciones por defectos, garantizamos su reparación o sustitución, según nuestro criterio.
4. En caso de fallar el cumplimiento posterior, el cliente puede exigir según su elección una rebaja de la remuneración (reducción) o la cancelación del contrato (rescisión). En caso de infracción leve del contrato y especialmente en caso de defectos leves, al cliente no le corresponde ningún derecho de rescisión.
5. El derecho a reclamaciones exige el correcto cumplimiento por parte del cliente de sus obligaciones de revisión y notificación según el Código de Comercio español, y R.D. Legislativo 1/2007 de 16 de noviembre especialmente los artículos 128 a 146. El cliente está obligado a probar el cumplimiento de la totalidad de los requisitos de reclamación, en particular el defecto mismo, el momento de la constatación del defecto y la notificación del defecto dentro de los plazos. Esto también se aplica a reclamaciones en relación con la cantidad, dimensiones y peso de las piezas.
6. Si, como consecuencia de vicios jurídicos y materiales tras un fallido cumplimiento posterior, el cliente opta por la rescisión del contrato, no tendrá derecho a reclamar daños y perjuicios por el defecto. Si, tras un fallido cumplimiento posterior, el cliente opta por reclamar daños y perjuicios, la mercancía permanecerá en las instalaciones del cliente siempre y cuando sea razonable para él. La indemnización por daños y perjuicios se limitará a la diferencia entre el precio de compra y el valor de la mercancía defectuosa. Esto no será aplicable, si de manera fraudulenta hubiésemos provocado el incumplimiento del contrato.
7. El plazo para las reclamaciones de garantía es de un año a partir del suministro de la mercancía. Esto no se aplicará, si el cliente no nos notifica el defecto dentro del plazo (véase apartado 5 de esta disposición).
8. En cuanto a la naturaleza y características de la mercancía, en principio, se tendrá en cuenta la descripción del producto del fabricante. Las declaraciones públicas, propaganda o publicidad del fabricante no equivalen a informaciones sobre características esenciales de la mercancía de carácter contractual.
9. Si el cliente recibe instrucciones de montaje o documentación técnica defectuosas, estamos obligados únicamente a suministrar unas instrucciones de montaje o documentación técnica correctas, y sólo si esta deficiencia impidiese un montaje correcto o un uso contractualmente correcto de la pieza de trabajo.
10. El cliente no recibe, por parte nuestra, garantías en sentido jurídico. Las garantías del fabricante no se verán por ello afectadas.

#### 10. Limitaciones de responsabilidad

1. En el caso de incumplimiento de obligaciones por negligencia leve, nuestra responsabilidad se limita al daño medio previsible, contractual e inmediato según el tipo de material. Esto también es aplicable en el caso de incumplimientos de obligaciones por negligencia leve de nuestros representantes legales o intermediarios. No nos responsabilizamos, en el caso de incumplimientos por negligencia leve, de obligaciones contractuales complementarias.
2. Las limitaciones de responsabilidad precedentes no son válidas para las reclamaciones del cliente derivadas de la responsabilidad del producto. Además, las limitaciones de responsabilidad no se aplicarán en caso de daños físicos y daños para la salud no imputables o en caso de fallecimiento del cliente.
3. Las reclamaciones de indemnización por daños y perjuicios del cliente a consecuencia de un defecto prescriben al cabo de tres (3) años de la entrega de la mercancía.

#### 11. Control de exportaciones

1. El cliente se compromete a recabar información en las autoridades locales del país en el que está establecido sobre las condiciones en las que se debe importar el producto solicitado. El producto se deberá declarar a las autoridades competentes y, en caso de que sea necesario se deberán pagar las tasas aplicables. El cliente deberá comprobar en las autoridades locales las opciones de importación y las posibilidades de uso del producto o los servicios solicitados. El cliente se compromete además a asegurarse de que las características técnicas indicadas por el fabricante se corresponden con los requisitos legales del país en el que se va a realizar la importación.
2. Antes de realizar la exportación de las mercancías en las que se instalarán los productos de ROS, el vendedor deberá obtener todos los permisos de exportación necesarios. Asimismo, los productos no se podrán vender ni transmitir directa o indirectamente a empresas, personas o países, en tanto ello atente contra las leyes o regulaciones de control de exportaciones. El comprador no tendrá derecho a devolver las mercancías.
3. El cliente no tendrá derecho a devolver las mercancías o a exigir daños y perjuicios si se le niega un permiso de exportación. No asumiremos ninguna responsabilidad en caso de que el cliente viole la ley. El cliente nos eximirá de todos los derechos o sanciones relacionados con los objetos suministrados que haya contra nosotros como consecuencia de infracciones que se hayan cometido contra las leyes de control de exportaciones.

#### 12. Reserva de dominio

1. Hasta que se satisfagan todas las exigencias (incluidos los balances de cuentas corrientes), que nos corresponden ahora o en el futuro frente a nuestros clientes por cualquier motivo legal, se nos

conceden las garantías reguladas en los siguientes párrafos 2 a 9. A petición del cliente, cederemos las garantías a nuestra discreción y siempre que su valor no supere en más de un diez por ciento (10%) el de nuestras exigencias.

2. La mercancía seguirá siendo de nuestra propiedad. El tratamiento y elaboración será siempre realizado por nosotros en calidad de fabricante, aunque sin ninguna obligación por parte nuestra. Si nuestra (co-)propiedad se extingue mediante fusión o asociación, desde ese mismo momento se acordará la transmisión de la (co-)propiedad del cliente sobre el objeto unificado de manera proporcional a su valor (valor de la factura).
3. El cliente ostentará nuestra (co-)propiedad gratuitamente. La mercancía que nos corresponde en (co-)propiedad, se denominará en lo sucesivo mercancía reservada.
4. Nuestro cliente tiene derecho a procesar y a vender la mercancía reservada dentro del marco habitual de su negocio. Las exigencias (incluidas todas las exigencias de saldo de cuentas corrientes) derivadas de la venta ulterior, elaboración o de cualquier otra razón legal (seguro, acto ilícito) con respecto a la mercancía reservada serán cedidas a nosotros por el cliente en su totalidad. Aceptaremos la cesión. Ninguno de nuestros derechos de reserva de dominio (reserva de cuenta corriente simple, ampliada o extendida) expirará aunque la mercancía entregada por nosotros haya sido adquirida por otro comprador, en tanto en cuanto no se haya satisfecho el pago de la mercancía. Esto se aplica especialmente en el caso de venta en el marco de empresas vinculadas.
5. Autorizamos al cliente de forma revocable a cobrar por nuestra cuenta y en nombre propio las exigencias que se nos ha cedido. Nos reservamos el derecho de cobrar nosotros mismos las exigencias si el cliente no cumple debidamente con sus obligaciones de pago, incurre en mora o existe una solicitud de apertura de un proceso de insolvencia o cesación de pagos. Si este fuese el caso, podríamos exigir al cliente que nos notificase las exigencias cedidas, indicase todos los datos necesarios para el cobro, entregase la documentación correspondiente y comunicase a los deudores (terceras partes) la cesión.
6. En caso de acceso de terceros a la mercancía reservada, el cliente deberá poner en conocimiento nuestra titularidad.
7. A modo de garantía de nuestras exigencias, el cliente nos cederá también las garantías que le corresponden que se deriven de la unión frente a un tercero de la mercancía con un bien inmueble.
8. El cliente tiene la obligación de comunicarnos inmediatamente el acceso de un tercero a la mercancía, especialmente en el caso de embargo, de posibles daños o de destrucción de la mercancía. Si la tercera parte no está en condiciones de compensar los gastos judiciales y extrajudiciales de un procedimiento judicial con arreglo al art 394 LEC, el cliente responderá de las pérdidas sufridas. El cliente deberá notificarnos inmediatamente el cambio de propiedad de la mercancía así como cualquier cambio de dirección.
9. En el caso de que el cliente muestre un comportamiento contrario al contrato, especialmente en el caso de demora de pago, estamos autorizados a retirar la mercancía reservada y en caso necesario, exigir la cesión de los derechos de restitución de nuestro cliente frente a terceros. Ni la retirada o el embargo de la mercancía reservada por parte nuestra constituirán una rescisión del contrato.
10. A petición nuestra, el cliente está obligado a revelar quién es su comprador, comunicarle la cesión, facilitarnos la información necesaria para hacer valer nuestros derechos frente al comprador y entregar la documentación necesaria. Además, tenemos derecho a notificar al comprador de nuestro cliente la cesión.
11. En el caso de haber acordado con el cliente pagos de la deuda del precio de compra según el procedimiento de cheque/pagaré/ letra de cambio, la reserva se extenderá también al cobro de la letra de cambio aceptada por nosotros por parte del empresario y no expirará con el abono del cheque recibido por nosotros.
12. El cliente está obligado a tratar la mercancía con cuidado. Si fuesen necesarios trabajos de mantenimiento e inspección, el cliente los deberá realizar a tiempo y correrá con los gastos derivados de ello. A petición nuestra, se nos debe facilitar en todo momento un inventario y una identificación suficiente de la mercancía reservada en el lugar de almacenamiento correspondiente.

#### 13. Prescripción

Nuestros derechos a indemnización por la entrega de bienes muebles que han de fabricarse y producirse prescriben al cabo de cinco (5) años.

#### 14. Disposiciones finales

1. El cliente sólo podrá transmitir a un tercero los derechos y obligaciones resultantes de este contrato con nuestro consentimiento previo por escrito.
2. El lugar de cumplimiento para el suministro y para pagos es Sant Jaume de Llierca (Girona, España).
3. El tribunal o juzgado competente será el correspondiente a la sede de nuestra empresa, siempre y cuando el cliente sea un comerciante, persona jurídica de derecho público o un patrimonio de derecho público. Esto mismo se aplicará si el cliente no dispusiese de ninguna jurisdicción general o si, en la fecha de la interposición del recurso, no se conociese su domicilio o residencia habitual. Asimismo, tenemos derecho a demandar ante un tribunal que corresponda a la sede o a una filial del demandante.
4. Se aplicará el derecho español para estas condiciones de entrega y de pago, y para todas las relaciones jurídicas existentes entre nosotros y nuestro cliente. No serán aplicables las disposiciones de la CISG (Convención de las Naciones Unidas sobre los Contratos de Compraventa Internacional de Mercaderías).
5. El cliente reconoce que no se vulnerarán derechos de terceros a través de su pedido.
6. En el caso de que hayamos proporcionado una garantía de fiel cumplimiento, el comprador o cliente no podrá recurrir a ella a primer requerimiento. Un reclamo de beneficios sólo se llevará a cabo después y con la presentación del correspondiente laudo arbitral.
7. Si algunas de las cláusulas del contrato contraído con el cliente incluidas las presentes condiciones de entrega y pago resultan o resultasen total o parcialmente inválidas, ello no afectaría a la validez del resto de las cláusulas. La disposición total o parcialmente invalidada deberá ser sustituida por una disposición cuyo efecto económico se aproxime lo más posible al de la regulación invalidada.

# GENERAL TERMS AND CONDITIONS

## 1 General aspects, area of validity

1. Our general delivery and payment terms apply to companies as defined under Art. 1 of the Commercial Code (22/8/1885) and Law 7/1998 of 13 April. Entrepreneurs, in this sense, are any natural person or legal entity or incorporated business partnership with whom we enter into a business relationship and who acts in a corporate capacity or as a self-employed professional.
2. The following terms apply to all our offers and deliveries. They apply to all current and future business relations, even if they are not explicitly agreed upon.
3. The customer's purchase terms are not part of the contract. They are not accepted if, after receipt, we explicitly object to them. At the latest on receipt of the goods and the services supplied by us, our general delivery and payment terms are deemed as accepted. Varying agreements are only binding if we acknowledge them in writing.
4. The rights arising from this contract cannot be transferred to another party.

## 2 Guarantees of the contract

1. All our offers, whether made verbally or in writing, are subject to confirmation and are non-binding. They do not constitute an obligation to deliver. With the purchase order acknowledgement, the customer declares with binding effect that they want to place the order or to purchase the goods. We reserve the right to accept the contractual offer included in the order within two (2) weeks of receipt. The acceptance can be declared either in writing or through delivery to the customer of the goods. Our purchase order acknowledgement determines exclusively the scope of the contractually due service.
2. Conclusions of transactions through representatives are binding for the customer but shall only be valid with a written acknowledgment by us.
3. We reserve sole ownership and copyright to any documents which belong to the offer. Without our prior agreement, these documents may not be distributed to third parties. If the order is not placed, the documents have to be returned to us upon our request and destroyed. Prices of individual sales positions are only valid as part of the total offer. Drawings, images, measurements, weights and other service data only have a binding effect if this is explicitly agreed in writing.
4. When the customer orders the goods electronically, we will immediately acknowledge the receipt of the order. The notification of order receipt is not yet an acceptance with binding effect of the order. The notification of order receipt can be combined with the notification of acceptance. If the customer orders the goods by electronic means, we save the contract text, and upon request, it will be sent by e-mail to the customer in addition to the present general delivery and payment terms.
5. We reserve the right to make changes of type of construction, material selection, specifications and design even after sending a notification of order acceptance provided that those modifications do not contradict the notification of order acceptance or the specifications of the customer. The customer will agree to the proposed modifications if they find them reasonable.

## 3 Tolerances

In order to fulfil the dimensional features of our products, tolerances apply. Unless we, as suppliers, explicitly state otherwise, we manufacture within our standard range tolerances.

## 4 Pricing

1. Our prices result from the notification of order acceptance. Our prices are in Euros per unit with the goods located in our warehouses in Sant Jaume de Llierca (Girona, Spain), excluding packing, shipping and other transportation costs, and tariff-free (foreign countries).
2. If between closing of contract and the delivery or service there is an increase in the prices of our suppliers, our costs (e.g. freight, wages and raw material, etc.) or our taxes, or other new taxes are introduced, we are entitled to increase our price accordingly, except when the price is explicitly confirmed as a fixed price.
3. If we consider a request for a modification by a customer, we are entitled to charge the customer for the resulting extra costs.
4. The customer will be charged with value-added tax, pursuant to statutory regulations. Any increases in the value-added tax rate between the time of placing the order and delivery are borne by the customer.

## 5 Payment terms

1. Our deliveries are due for payment (without any deduction) within THIRTY (30) calendar days of receipt. After this stated payment period, the customer is in default.
2. Granting a discount needs a formal individual contract - and additionally as a further requirement - that by then all outstanding invoices are settled. For the discount calculation, the net invoice amount (after deduction of abatements, freight charges and other costs passed on to third parties) is decisive.
3. We are not obliged to accept bills of exchange, promissory notes, cheques or confirming. We accept bills of exchange only when subject to a discount option. Cheques, promissory notes and bills of exchange will be first credited after check encashment, and assignments of debt will be first credited after payment. Until then, the amount receivable and its payment due dates remain unchanged. No liability is accepted for prompt presentation or protest. Protest and collection charges will be borne by the customer.
4. When applicable, we are entitled to impute payments first to earlier debts of a customer despite contrary terms of this customer.
5. The retention of payments or the offsetting of possible customer counterclaims - contested by us - will be not allowed.
6. In case of the customer's (debtor's) failure to comply with the terms of payment, all outstanding debts will become immediately due. The customer's payment default is subject to detention of the goods, pursuant to the stipulations of the following § 5.

## 6 Default and credit unworthiness

1. After expiry of the agreed payment deadlines (default) or receipt of cheque, promissory note and/or bill of exchange protest, we are entitled to

- withdraw from all contracts and demand damages due to the failure to fulfil obligations
- exercise our retention of title and take possession of the goods delivered (cf. § 10 below)
- demand collateral and use the collateral demanded
- declare all unpaid accounts due and deliver only against prepayment
- charge default interest, starting from the due date, in an amount of eight percent above the basic interest rate of the European Central Bank, plus entitlement to charge the accruing default interest of the current value-added tax
- charge any further possible default damage after submitting appropriate evidence to the customer.

2. In case of judicial enforcement or in case of filing a bankruptcy proceeding in regards of the assets of the customer, all rebates, bonuses and discounts granted on unpaid bills shall not be valid.

## 7 Delivery deadlines

1. Received orders are only considered as accepted after issuance of our written notification of acknowledgement. The delivery dates and delivery times are just approximate times (and may be subject to previous outstanding non-payments). Delivery dates and delivery times, which can be stipulated with and without binding effect, have to be made in writing.
2. Delivery times that are not part of a fixed delivery date start with the date of our notification of order acknowledgment. Delivery times and delivery dates are considered as fulfilled when the goods are shipped or when readiness for shipment is communicated within the deadline.
3. Delivery times and delivery dates are extended for the length of the time for which the customer is in default towards us with this or other orders pursuant to their obligations, notwithstanding our other rights concerning the customer default.
4. If we are the cause of the delivery delay, the customer may withdraw from the contract after an appropriate respite time has passed, set by the customer, or may request damages if the damage involves gross negligence or intentional damage on our part. However, the customer is restricted to the extra costs for a substitute purchase. Further claims do not apply. Liability for minor negligence is particularly precluded. Liability limitation for minor negligence does not apply in case of injury to body or health attributable to us or loss of the customer's life.
5. It is agreed that partial deliveries may be made, except when it is explicitly excluded in writing. For the payment of partial deliveries, § 4 of these general delivery and payment terms applies.

## 8 Shipping terms

1. The risk of accidental loss or accidental deterioration of the goods passes to the customer with delivery of the goods. In the event of shipment, with the delivery of the product it passes to the carrier or the haulier or any other person or agent in charge of carrying out the shipment. The shipping takes place mainly ex works - unless otherwise agreed.
2. If free delivery is agreed, the risks of accidental loss or accidental deterioration of the goods/item sold passes on with arrival of the vehicle in front of the delivery address, on the ground floor or at a spot which is reasonably accessible for the vehicle. Our customer is obliged to provide necessary equipment or workers for unloading, in so far as this is technically possible.
3. The handover is the same if the customer is in default of acceptance.
4. If the goods are ready for shipment but the receipt or the shipment is delayed, and we are not the cause, the risks pass to the customer with receipt of the shipping readiness notification. Supplies ready for shipping have to be immediately accepted, at the latest within a period of five (5) weekdays after the notification date of shipment readiness. We are otherwise entitled to ship the goods as per our own criteria. If the shipment or transportation of the goods should be delayed for reasons not attributable to us, we are entitled but not obliged to store the goods at our own discretion at the expense and risk of the customer and under exclusion of our liability and to pass the resulting costs to the customer. We are also entitled to take appropriate measures for the preservation of the goods and to charge the goods as delivered.
5. Without specific shipping instructions, we select, to the best of our ability but without liability, the most affordable shipping method. We are entitled to purchase, at the expense of the customer, a transport and breakage insurance. Damage claims have to be notified within a period of two weeks. They must be confirmed in writing, and evidence of their nature and scope has to be provided. With handover of the goods to the carrier or haulier, this responsibility is passed on to the customer, at the latest with goods departure from the factory or the storage facility. This will be applied even if the delivery is made using our own vehicles.
6. Our delivered goods can be only returned free of transportation charges when they are in perfect condition or after our prior agreement. Voluntarily accepted returned goods will be credited, in accordance with their condition minus a share of costs of at least fifty percent (50 %) of the value of the returned goods. The credit takes place after the goods have been received and inspected in our facility. A return of custom-made goods or goods supplied especially according to customer specifications is excluded.

## 9 Responsibility for defects

We provide a warranty for defective products including the lack of guaranteed quality, pursuant to the following requirements:

1. Our warranty refers to proper execution and usage of faultless materials. The warranty does not cover damage caused by natural wear and tear, excessive use and improper installation.

2. After receipt by the customer of goods delivery as specified in the contract, the allegation of defects, which are found during the delivery process as stipulated in the contract, is excluded.
  3. We guarantee repair or replacement, at our discretion, for legitimate claims for defects.
  4. If the subsequent performance fails, the customer can choose between a price reduction and cancellation of the contract. In the event of a minor contract violation, especially if it is a minor defect, the customer is not entitled to cancel the contract.
  5. Customer claims require that they complied properly with their inspection and notification obligations, pursuant to the Spanish Commercial Code, and Legislative R.D. 1/2007 of 16 November, especially Articles 128 to 146. The customer must accept the full burden of proof for all claim requirements, particularly for the defect as such, for the time of the defect detection and for the timely notification of the defect.
- The same also applies to claims regarding the quantities, dimensions and weight of the parts.
6. If the customer chooses a rescission of the contract - after failed subsequent performance – by reason of a legal or material deficiency, they are not entitled to a claim for damages due to defect. If the customer chooses to claim damages after a failed subsequent performance, the goods shall stay in the customer's facilities, in so far as they deem this to be reasonable. The damages shall be limited to the difference between the purchase price and the value of the defective goods. This shall not apply if we caused the contract violation maliciously.
  7. The warranty period is one year after delivery of the goods. This shall not apply when the customer did not notify us in a timely manner about the deficiency (cf. paragraph 6. of this provision).
  8. With regard to the nature and characteristics of the goods, as a principle, only the product description of the manufacturer is agreed upon and takes effect. Public statements, promotions or advertisements of the manufacturer are not contractual statements on the essential characteristics of the goods.
  9. If the customer receives a deficient assembly instruction or a deficient technical documentation, we are only obliged to supply an assembly instruction or technical documentation which is free of any deficiency, and only when the deficiency causes problems for proper assembly or the contractual usage of the part.
  10. The customer does not receive legal guarantees from us. Manufacturer's warranties remain unaffected.

#### 10 Liability limitations

1. In the event of a breach of duty due to minor negligence, our liability is limited to the foreseeable, contractual and average direct damage according to the kind of material. This also applies to the breach of duty due to minor negligence by our legal representatives or intermediaries. We are not liable in case of violations of complementary contractual obligations due to minor negligence.
2. The above liability limitations do not apply to the customer claims for product liability. Liability limitations do not apply in case of non-attributable physical and health damage or the customer's loss of life.
3. The customer's claims for damages due to a defect expire three (3) years after delivery of the goods.

#### 11 Export controls

1. Customers are obliged to ascertain, from the local authorities of the country in which they are resident, information on the conditions under which the ordered item must be imported. The product must be declared to the competent authorities and, if necessary, any accruing fees and charges must be paid. The customer must check the import options and possibilities of use of the products or services requested with the local authorities. The customer is further obliged to ensure that the technical characteristics specified by the manufacturer comply with the legal requirements of the country into which the products or services are going to be imported.
2. Before the export of goods in which ROS products are installed, the seller shall obtain all required export licences and shall not sell or pass on the products, whether directly or indirectly, to companies, persons or countries if this violates export control laws or regulations. The buyer shall not be entitled to return the goods.
3. The customer shall not be entitled to return the goods or to demand compensation if they are denied an export licence. We are not liable for any violation of the law on the part of the customer. The customer shall exempt us from any claims or other penalties against us arising from violation of export control laws in connection with the delivered items.

#### 12 Retention of title

1. Pending the fulfilment of all accounts receivable (including the balance of the current account) to which we are entitled against the customer legally for any reasons now or in the future, we will be granted the guarantees regulated in the following paragraphs 2 through 9. At the customer's request, we will assign the guarantees at our own discretion as long as their value does not exceed our accounts receivable by more than ten percent (10%).
2. The goods will remain our property, and the workmanship and processing shall always be conducted by us as the manufacturer but without our obligation. Should our (joint) ownership expire due to association or merger, it is agreed that the (joint) ownership of the object by the customer shall be transmitted proportionally with its value (invoice value).
3. The customer shall hold our (joint) property free of charge. Goods in relation to which we are entitled to (joint) ownership are described below as retained goods.

4. Our customer is entitled to process and sell retained goods in the course of appropriate business. The customer assigns the full amount of the accounts receivable at closure of the contract to us. This results from the re-sale, processing or any other legal reason (insurance, tort) of the retained goods (including all accounts receivable from the current account balance). We shall accept the assignment. None of our property rights (simple, expanded, extended open account title) shall expire, even if the goods, which were delivered by us, were purchased by another buyer, and as long as they did not pay us for the goods. This applies particularly to sales in the scope of affiliated companies.
5. We revocably authorize the customer to collect the accounts receivable assigned to us in their own name but for our account. We reserve the right to collect the accounts receivable ourselves if the customer does not properly keep up with their payment obligations, if they incur default or file a request for opening of a bankruptcy proceeding or if they cease payments. If this should be the case, we may demand that the customer notifies the assigned accounts receivable and all necessary information for collection purposes to us and that they hand over the corresponding documents to us and inform the debtor (third parties) about the transfer.
6. In case of access by third parties to the retained goods, the customer must make them aware of our property rights.
7. The customer shall also surrender to us - for the security of our accounts receivable – the guarantees to which they are entitled, in relation to a third party, which result from the connection of the goods to a property.
8. The customer is obliged to notify us immediately about third party access to the goods, especially in the event of a seizure as well in case of possible damage or destruction of the goods. If the third party is unable to pay the judicial and extrajudicial costs of legal proceedings, pursuant to Art. 394 LEC (Civil Procedure Act), the customer will be liable to pay for the loss incurred. The customer must notify us immediately in case of transfer of the good to another owner as well as any change of their own address.
9. In case of breach of contract by the customer – particularly default – we are authorized to take the retained goods back and to demand, if necessary, the surrender of claims by our customer against third parties. The removal as well as the seizure of the retained goods by us is not a rescission of the contract.
10. At our request, the customer is obliged to name its buyers to us, to inform them about the assignment, to inform us about the necessary data for entitlement of our rights against the buyers and to hand over the necessary documents. We are also entitled to notify the buyers of our customers about the assignment.
11. If we stipulate with the customer payments of the purchase price debt based on the check/promissory note/bill of exchange procedure, the retention of title clause also extends to the encashment of the bill of exchange accepted by us by the company and does not expire with the payment of the cheque received by us.
12. The customer is obliged to handle the goods with care. As far as maintenance and inspection work is necessary, the customer must exercise this on time and at their own expense. At our request at any time, an inventory and sufficient identification of the retained goods in the respective storage location should be made available to us.

#### 13 Expiration

Our claims of compensation for delivery of moveable property to be manufactured and produced expire after five (5) years.

#### 14 Final provisions

1. The transfer of rights and obligations of the customer from this contract to a third party needs our prior written consent.
2. Place of delivery and payment is Sant Jaume de Llierca (Girona, Spain).
3. The appropriate court corresponding to our company headquarters has the legal jurisdiction if the customer is a merchant, a legal identity under public law or assets under public law. The same shall apply if the customer has no general place of jurisdiction or if its location or habitual residency at the time of commencement of legal proceedings are not known. We are also entitled to file commencement for legal proceedings before a court which has jurisdiction over the location or branch of the plaintiff.
4. For these delivery and payment terms and all legal relationships between us and our customer, Spanish laws shall apply. The provisions of the CISG (United Nations Convention on Contracts for the International Sale of Goods) shall not apply.
5. The customer acknowledges that no rights of third parties shall be violated through its order.
6. If we provided a performance guarantee, the buyer or customer is not entitled to use it upon first demand. A claim for benefits shall follow only after and under submission of an appropriate arbitration award.
7. Should individual provisions of this contract with the customer, including these general delivery and payment terms, be or become totally or partially invalid, this shall not affect the validity of the remaining provisions. The provision which is invalid, whether in part or in its entirety, must be replaced by a provision whose economic effect will be as close as possible to the effect intended by the invalid provision.

# CONDITIONS GÉNÉRALES DE VENTE

## 1 Généralités, champ d'application

1. Nos conditions générales de paiement et de livraison s'appliquent aux sociétés conformément à l'article 1 du Code de commerce (22/8/1885) et à la loi 7/1998 du 13 avril. A cet effet, un entrepreneur doit être entendu comme toute personne physique ou morale ou entreprise individuelle ayant la capacité d'agir avec laquelle une relation commerciale est établie et qui exerce une activité professionnelle commerciale ou pour son propre compte.
2. Les conditions mentionnées ci-après sont valables pour l'ensemble de nos offres et livraisons. Elles s'appliquent à toutes les relations commerciales présentes et futures, même si elles ne sont pas explicitement convenues à nouveau.
3. Les conditions d'achat du client ne font pas partie du contrat. Elles ne sont pas non plus reconnues par notre société si, après réception, nous nous y opposons expressément. Nos conditions générales de paiement et de livraison sont considérées comme acceptées au plus tard à la réception des marchandises et des services fournis par nous. Les modifications de ces conditions ne sont valables que si elles sont convenues par écrit.
4. Les droits résultant du présent contrat sont incessibles.

## 2 Garanties du contrat

1. Toutes nos offres, soumises par écrit ou oralement, sont sujettes à confirmation et ne sont pas contraignantes, autrement dit, elles ne nous engagent pas à effectuer la livraison. Par la confirmation de la commande, le client déclare de manière contraignante vouloir acquérir les articles commandés ou vouloir passer la commande. Nous nous réservons le droit d'accepter l'offre contractuelle incluse dans la commande dans les deux (2) semaines suivant sa réception. L'acceptation peut être communiquée au client soit par écrit, soit par la livraison de la marchandise. Seule notre confirmation de commande fait foi pour l'étendue de la prestation contractuelle à fournir.
2. Les contrats conclus avec les représentants sont contraignants pour les clients, mais ils ne seront valables qu'après avoir été confirmés par nous par écrit.
3. Nous nous réservons les droits de propriété et d'auteur sur les documents faisant partie de l'offre. Ces documents ne doivent pas être cédés à des tiers sans notre autorisation préalable. Si la commande n'est pas passée, ces documents doivent nous être restitués si nous en faisons la demande ou détruits. Les prix de chacun des articles de l'offre ne seront considérés comme valables qu'après la passation de la commande complète de ladite offre. Les dessins, photos, dimensions, poids et toutes autres données faisant référence à nos services ne sont contraignants que si cela a été expressément convenu par écrit.
4. Si le client commande la marchandise par voie électronique, nous confirmerons la réception de la commande sans délai. Mais la confirmation de la réception de la commande ne représente pas encore une acceptation contraignante de la commande. La confirmation de réception peut être liée à la confirmation de l'acceptation. Si le client commande la marchandise par voie électronique, nous enregistrons le texte du contrat et nous l'envoyons par courriel au client sur simple demande en y joignant les présentes conditions.
5. Nous nous réservons le droit de modifier la conception, le choix des matériaux, les spécifications et le type de fabrication, même après avoir envoyé la confirmation de la commande, à condition que ces modifications ne soient incompatibles ni avec la confirmation de la commande, ni avec les spécifications du client. En outre, le client doit donner son accord concernant les modifications proposées, dans la mesure où elles lui conviennent.

## 3 Tolérances

Des tolérances sont définies pour la conformité des caractéristiques dimensionnelles de nos produits. Sauf indication contraire de notre part en tant que fournisseur, nous fabriquons conformément à nos tolérances standard.

## 4 Prix

1. Nos prix sont indiqués dans la confirmation de la commande. Ils sont entendus en euros/unité, départ usine, autrement dit depuis nos entrepôts de Sant Jaume de Llierca (Géronne) (Espagne), frais d'emballage, d'expédition, de port et droits de douane (pour l'étranger) non compris.
2. Si entre la signature du contrat et la livraison ou la prestation du service, les prix de nos fournisseurs, ainsi que nos coûts (par exemple, augmentations des prix du fret, augmentations de salaires ou du prix des matières premières) ou nos taxes augmentent ou si de nouveaux frais se produisent, nous sommes en droit d'augmenter le prix en conséquence, à moins que le prix n'ait été expressément fixé.
3. Si nous tenons compte des propositions de modification du client, nous sommes en droit de facturer au client les coûts supplémentaires qui en résultent.
4. La T.V.A. est facturée conformément aux dispositions légales en vigueur. Toute augmentation du taux de T.V.A. entre le moment de la commande et la livraison est à la charge du client.

## 5 Conditions de paiement

1. Le paiement de nos fournitures doit être effectué, sans aucune déduction, dans les TRENTE (30) jours civils suivant leur réception, après quoi le client sera considéré en retard de paiement.
2. Outre un accord individuel exprès, il est exigé comme condition supplémentaire pour concéder des réductions que toutes les factures antérieures à la date aient été réglées. Pour le calcul de la remise, le montant net de la facture est déterminant, après déduction des escomptes, des frais de port et d'autres coûts à répercuter à des tiers.
3. Nous ne sommes pas tenus d'accepter des traites, des billets à ordre, des chèques ou du confirming (reverse factoring). Nous n'acceptons les traites que sous réserve d'une possibilité d'escompte. Les chèques et les traites ne sont crédités au client qu'après encaissement en espèces et les cessions de créances ne sont créditées qu'une fois le paiement effectué. Avant l'encaissement ou le paiement, la créance et son exigibilité ne seront en rien modifiées. Nous n'assumons aucune responsabilité en cas de présentation ou de protêt ponctuels. La gestion du protêt et les commissions de recouvrement sont à la charge du client.
4. Malgré des dispositions éventuellement divergentes du client, nous sommes en droit de réclamer les factures impayées contractées par le client auparavant, par ordre d'ancienneté.
5. Le client n'est pas en droit de retenir des paiements ou de les compenser par la présentation de récla-

mations que nous aurions contestées.

6. En cas de non-respect des conditions de paiement par le client (débitur), toutes les créances restant dues seront exigibles immédiatement. Conformément aux dispositions convenues au § 5, le retard de paiement du client entraîne la rétention de la fourniture.

## 6 Retard de paiement et insolvabilité

1. En cas de dépassement des délais de paiement convenus (retard de paiement) ou en cas de notification de protêt de chèques et/ou de traites, nous sommes en droit de :
  - résilier tous les contrats et d'exiger des dommages et intérêts pour non-exécution ;
  - de faire valoir notre réserve de propriété et de reprendre possession de la marchandise fournie (cf. § 10 ci-après) ;
  - d'exiger des garanties et d'exécuter les garanties reçues ;
  - d'exiger le paiement de toutes les factures restant dues et de n'effectuer les livraisons restant dues que contre paiement anticipé ;
  - à compter de la date d'échéance, de facturer des intérêts de retard d'un montant de huit pour cent sur le taux d'intérêts de base de la Banque centrale européenne, plus les intérêts de retard de la T.V.A. exigible en vigueur à ce moment<sup>TT</sup> là ;
  - le cas échéant, de réclamer au client des intérêts de retard supplémentaires sur présentation des justificatifs correspondants.

2. En cas de procédure judiciaire ou d'ouverture d'une procédure d'insolvabilité à l'encontre du patrimoine du client, tous les rabais, ristournes et remises accordés sur l'ensemble des factures restant dues sont caduques.

## 7 Délais de livraison

1. Les commandes reçues par notre société ne doivent être considérées comme acceptées qu'après notre confirmation écrite. Les délais et les dates de livraison sont toujours donnés à titre indicatif (et peuvent être soumis au paiement de factures impayées précédemment). Les dates et délais de livraison, stipulés avec ou sans contrainte, doivent être convenus par écrit.
2. Les délais de livraison convenus sans indication d'une date de livraison précise courent à compter de la date de notre confirmation de commande. Les délais et dates de livraison sont considérés comme respectés si, avant l'expiration du délai, la marchandise quitte le lieu d'expédition ou si notre société notifie au client qu'elle est prête à être expédiée.
3. Outre nos droits résultant du retard du client, les délais et dates de livraison peuvent être prolongés tant que le client n'aura pas respecté ses obligations envers notre société découlant du présent contrat ou d'autres contrats.
4. Si nous sommes de notre côté en retard de livraison, le client est en droit, après expiration du délai supplémentaire fixé par lui, de résilier le contrat ou encore d'exiger de notre société des dommages et intérêts en cas de dommages intentionnels ou de négligence grave de notre part. Mais ces dommages et intérêts sont limités aux surcoûts encourus pour effectuer un achat afin de se procurer la marchandise. Les autres droits ne sont pas applicables. La responsabilité pour négligence légère est particulièrement exclue. La limitation de responsabilité en cas de négligence légère ne s'applique pas en cas de dommages corporels, d'atteintes à la santé ou de décès du client, étant imputables à notre société.
5. Il est convenu que des livraisons partielles sont autorisées, sauf si cela a été expressément exclu par écrit. Pour le règlement de livraisons partielles, le § 4 des présentes conditions générales de paiement et de livraison est applicable.

## 8 Conditions d'expédition

1. Les risques de perte ou de détérioration accidentelle de la marchandise sont transférés au client au moment de la livraison de la marchandise et, en cas d'expédition, au moment de la remise de la marchandise au commissionnaire de transport, au transporteur, à la personne ou à l'agence chargée d'effectuer l'expédition. En principe, l'expédition s'entend départ usine, tant qu'il n'en a pas été convenu autrement.
2. S'il est convenu une livraison franco de port, les risques de perte ou de détérioration accidentelle de la marchandise/de l'objet vendu sont transférés au moment de l'arrivée du véhicule devant l'adresse de livraison, au rez-de-chaussée ou dans un endroit raisonnablement accessible avec le véhicule. Notre client est tenu, dans la mesure où cela est techniquement possible, de mettre à disposition les employés ou les engins nécessaires pour le déchargement.
3. Si le client est en retard d'acceptation de la marchandise, ces conditions sont également applicables.
4. Si la marchandise est prête à l'expédition et si la réception ou l'expédition est retardée pour des raisons qui ne nous sont pas imputables, les risques sont transférés au client dès réception de la notification de disponibilité de l'expédition. Les fournitures prêtes à l'expédition doivent être acceptées immédiatement au plus tard dans un délai de cinq (5) jours ouvrés suivant la date de notification de disponibilité de l'expédition. Dans le cas contraire, nous sommes en droit d'expédier la marchandise à notre convenance. Si le chargement ou le transport de la marchandise est retardé pour des raisons qui ne nous sont pas imputables, nous sommes en droit, mais non tenus, de stocker la marchandise à notre convenance aux frais et aux risques du client, et ce sans aucune responsabilité de notre part. Les frais ainsi occasionnés seront facturés au client. Nous sommes également en droit de prendre toutes les mesures jugées nécessaires pour la conservation de la marchandise et de facturer la marchandise comme si elle avait été livrée.
5. Sans indications précises pour l'expédition, nous l'effectuons à notre convenance, mais sans en assumer la responsabilité, par le mode d'expédition le moins cher. Nous sommes en droit de souscrire une assurance de transport et contre la casse qui sera à la charge du client. Les réclamations pour dommages doivent être notifiées et confirmées par écrit en apportant la preuve de la nature et de l'étendue des dommages dans un délai de deux semaines. Cette responsabilité est transférée au client au moment de la remise de la marchandise au commissionnaire de transport ou au transporteur et, au plus tard, lorsque la marchandise quitte l'usine ou l'entrepôt. Cela s'applique également si la livraison est effectuée par nos propres véhicules.
6. Le retour de la marchandise que nous avons fournie doit être effectué franco de port et nous ne l'accepterons que si la marchandise est en parfait état ou sur accord préalable. Si nous acceptons le retour de

la marchandise, nous procéderons à son remboursement en fonction de son état, en déduisant au moins cinquante pour cent (50 %) de la valeur de la marchandise retournée. L'avoir sera effectué après la réception et vérification de la marchandise dans nos installations. Le retour de fabrications spéciales ou de marchandises spécialement fournies conformément aux spécifications du client est exclu.

#### **9 Garantie des vices cachés**

Nous offrons une garantie contre la marchandise défectueuse, y compris le manquement à la qualité garantie conformément aux dispositions suivantes :

1. Notre garantie ne s'applique qu'en cas de montage et d'utilisation corrects de matériaux en bon état. Notre garantie ne couvre aucun dommage causé par l'usure naturelle, la charge excessive et le montage non conforme.
2. Une fois que le client a réceptionné la marchandise conformément à ce qui est prévu dans le contrat, ce dernier n'a plus le droit de notifier tout défaut qui aurait pu être découvert au cours du processus de livraison stipulé dans le contrat.
3. En cas de réclamations légitimes pour défauts, nous garantissons la réparation des articles ou leur remplacement, selon nos critères.
4. En cas de manquement à l'obligation subséquente, le client peut exiger à sa convenance une réduction du prix (remise) ou une annulation du contrat (résiliation). Mais le client n'a aucun droit à la résiliation en cas de faute contractuelle minime et, en particulier, en cas de vices mineurs.
5. Le droit à réclamations revenant au client présuppose que ce dernier a respecté correctement ses obligations de vérification et de notification qui lui incombent conformément au Code de commerce espagnol et au décret royal législatif 1/2007 du 16 novembre et notamment aux articles 128 à 146. Le client est tenu de prouver le respect de toutes les exigences concernant la réclamation, en particulier le défaut lui-même, le moment de la constatation du défaut et la notification de la réclamation pour défaut dans les délais convenus. Cela vaut également pour les réclamations relatives au nombre de pièces, à leur dimension et à leur poids.
6. Si, à la suite de vices légaux et matériels après un manquement à l'obligation subséquente, le client choisit de résilier le contrat, il n'aura pas le droit de réclamer de dommages et intérêts pour le vice. Si, après un manquement à l'obligation subséquente, la marchandise demeurera dans les locaux du client aussi longtemps que cela sera possible pour lui. L'indemnisation des dommages se limite à la différence entre le prix d'achat et la valeur de la marchandise défectueuse. Cela ne s'applique pas si nous avons occasionné la violation du contrat de façon dolosive.
7. Le délai pour les réclamations de vices sous garantie est d'un an à compter de la livraison de la marchandise. Cela ne s'applique pas si le client ne nous a pas notifié le vice dans ce délai (cf. le point 6 de la présente disposition).
8. En ce qui concerne la nature et les caractéristiques de la marchandise, en principe, seule la description du produit par le fabricant fait foi. Les déclarations publiques, les réclames ou la publicité du fabricant ne constituent pas des informations sur les caractéristiques essentielles de la marchandise à caractère contractuel.
9. Si le client reçoit des instructions de montage ou des documents techniques défectueux, nous sommes uniquement tenus de fournir des instructions de montage ou des documents techniques corrects et ce, seulement dans le cas où cette défaillance empêche un montage correct ou une utilisation contractuellement correcte de la pièce.
10. Nous n'accordons pas au client de garanties au sens juridique. Les garanties des fabricants ne sont en rien modifiées par la présente disposition.

#### **10 Limitations de responsabilité**

1. En cas de léger manquement à nos obligations, notre responsabilité est limitée aux dommages moyens prévisibles, contractuels et immédiats en fonction du type de marchandise. Cela s'applique également en cas de léger manquement aux obligations de nos représentants légaux ou de nos intermédiaires. En cas de légers manquements aux obligations, nous n'assumons aucune responsabilité concernant des obligations contractuelles complémentaires.
2. Les limitations de responsabilité mentionnées ci-dessus ne concernent pas les réclamations du client résultant de la responsabilité du fait du produit défectueux. En outre, les limitations de responsabilité ne s'appliquent pas en cas de dommages corporels, d'atteintes à la santé ou de décès du client, qui ne nous sont pas imputables.
3. Les réclamations de dommages et intérêts du client résultant d'un vice prescrivent au bout de trois (3) ans à compter de la livraison de la marchandise.

#### **11 Contrôles des exportations**

1. Le client s'engage à se renseigner auprès des autorités locales du pays dans lequel il est établi afin de connaître les conditions sous lesquelles le produit commandé peut être importé ; le produit doit être déclaré auprès des autorités compétentes et les frais éventuels en découlant doivent être payés. Le client doit contrôler auprès des autorités locales les possibilités d'importation et d'utilisation des produits ou services commandés. Le client s'engage également à s'assurer que les caractéristiques techniques indiquées par le fabricant sont conformes aux dispositions légales du pays d'importation.
2. Avant l'exportation des marchandises dans lesquelles seront installés les produits ROS, le vendeur doit obtenir l'ensemble des licences d'exportation nécessaires et s'engage à ne pas vendre ou transmettre les produits de façon directe ou indirecte aux entreprises, personnes ou pays en contravention avec les lois ou règlements sur le contrôle des exportations. L'acheteur n'est pas autorisé à retourner les marchandises.
3. Le client n'est pas en droit de retourner les marchandises ou de demander des dommages et intérêts lorsqu'une licence d'exportation lui est refusée. Nous nous dégageons de toute responsabilité en cas de violation de la loi par le client. Le client nous dégage de toute responsabilité vis-à-vis de toute réclamation ou d'autres sanctions existantes à notre encontre en raison de violations du droit relatif aux exportations en rapport avec les biens fournis.

#### **12 Réserve de propriété**

1. Jusqu'au recouvrement de toutes les créances, (y compris les soldes de comptes courants), qui nous reviennent vis-à-vis du client pour quelque raison juridique que ce soit, maintenant ou l'avenir, le client nous fournit les sûretés convenues aux paragraphes 2 à 9 ci-après. Sur demande du client, nous accorderons à notre convenance la mainlevée des sûretés dans la mesure où leur valeur ne dépassera pas le montant de nos créances de plus de dix pour cent (10 %).
2. Nous restons propriétaires de la marchandise. Le traitement et l'élaboration sont toujours effectués par nous en tant que fabricant, mais sans aucune obligation de notre part. Si notre (co)propriété expire suite à une fusion ou à une association, à partir de ce moment là, il est convenu que la (co)propriété du client sur l'objet unitaire sera cédée au prorata de la valeur de la marchandise (valeur de la facture).
3. Le client conserve notre (co)propriété gratuitement. La marchandise, dont nous détenons la (co)propriété, est désignée ci-après comme marchandise sous réserve de propriété.
4. Notre client est en droit de traiter et de vendre la marchandise sous réserve de propriété dans le cadre de ses activités commerciales ordinaires. Le client nous cède dès maintenant dans leur intégralité les créances (y compris toutes les créances de solde de comptes courants) résultant de la revente, de l'élaboration ou d'un autre motif juridique quelconque (assurance, acte illicite), liées à la marchandise sous réserve de propriété. Nous acceptons cette cession. Aucun de nos droits de réserve de propriété (réserve de propriété simple, élargie, prolongée ou clause de compte courant) n'expire, même si la marchandise que nous avons livrée est achetée par un autre acquéreur, tant que la marchandise n'aura pas été payée à notre société. Cela vaut en particulier pour la vente dans le cadre d'entreprises liées.
5. Nous autorisons le client de façon révocable à recouvrer en son nom et pour notre compte les créances qui nous ont été cédées. Nous nous réservons le droit de recouvrer les créances nous-mêmes dès que le client ne remplira pas ses obligations de paiement de façon conforme, s'il est en retard de paiement, si une demande d'ouverture de procédure d'insolvabilité a été déposée ou encore si le client est en cessation de paiements. Si tel est le cas, nous sommes en droit d'exiger que le client nous notifie les créances cédées, nous fournisse toutes les informations nécessaires au recouvrement des créances, nous remette les documents afférents et notifie la cession aux débiteurs (aux tiers).
6. En cas d'accès de tiers à la marchandise sous réserve de propriété, le client doit informer les tiers de notre propriété.
7. Pour garantir nos créances, le client nous cède également les sûretés qui lui reviennent résultant, vis-à-vis d'un tiers, de l'union de la marchandise avec un bien immeuble.
8. Le client est tenu de nous notifier sans délai l'accès d'un tiers à la marchandise, notamment en cas de saisie, de dommages subis par la marchandise ou de sa destruction. Si le tiers n'est pas en mesure de nous rembourser les frais judiciaires et extra-judiciaires occasionnés par une plainte conformément à l'article 394 de la loi de procédure civile, le client sera responsable des pertes que nous aurons subies. Le client doit nous notifier sans délai le changement de propriétaire de la marchandise ainsi que tout changement de domicile.
9. En cas de comportement contraire aux dispositions du contrat de la part du client, notamment en cas de retard de paiement, nous sommes en droit de reprendre la marchandise sous réserve de propriété et d'exiger le cas échéant la cession des droits de restitution de notre client vis-à-vis de tiers. La reprise ou la saisie de la marchandise sous réserve de propriété par notre société ne constitue pas une résiliation du contrat.
10. Suite à notre demande, le client est tenu de nous communiquer le nom de son acheteur, de lui notifier la cession, de nous fournir les renseignements nécessaires pour faire valoir nos droits vis-à-vis de l'acheteur et de nous remettre les documents afférents. Nous sommes également en droit de notifier la cession à l'acheteur de notre client.
11. Si nous convenons avec le client que les paiements de la créance résultant du prix de vente doivent être effectués par chèques et traites, la réserve s'étend également à l'encaissement par l'entrepreneur de la traite que nous avons acceptée et n'expire pas avec le paiement du chèque que nous avons reçu.
12. Le client est tenu de traiter la marchandise soigneusement. Dans la mesure où des travaux de maintenance et d'inspection seraient nécessaires, le client doit les effectuer régulièrement à ses frais. Suite à notre demande, il doit nous remettre à tout moment un inventaire et une identification suffisante de la marchandise sous réserve de propriété dans le lieu de stockage correspondant.

#### **13 Prescription**

Nos droits à indemnisation pour la livraison de biens meubles à fabriquer et à produire prescrivent au bout de cinq (5) ans.

#### **14 Dispositions finales**

1. La cession de droits et d'obligations, résultant du présent contrat, du client à un tiers requiert notre autorisation écrite préalable.
2. Le lieu d'exécution pour la fourniture et les paiements est Sant Jaume de Llierca (Gérone, Espagne).
3. La juridiction compétente est le tribunal correspondant à notre siège social dans la mesure où le client est un commerçant, une personne morale de droit public ou un organisme de droit public. Il en va de même si le client n'a pas de juridiction compétente ou si, à la date du dépôt de la plainte, son domicile ou sa résidence habituelle n'est pas connue. Nous sommes également en droit de déposer une plainte devant un tribunal qui correspond au siège ou à une filiale du demandeur.
4. Les présentes conditions de livraison et de paiement, ainsi que la totalité des relations juridiques entre notre société et nos clients sont régies par le droit espagnol. Les dispositions de la CVIM (Convention des Nations Unies sur les contrats de vente internationale de marchandises) ne s'appliquent pas.
5. Le client doit nous confirmer que sa commande ne viole pas les droits de tiers.
6. Si nous avons fourni une garantie légale de conformité, l'acheteur ou le client n'est pas en droit de la faire valoir à la première requête. Une réclamation pour perte de bénéfices ne peut être introduite que suite et sur présentation de la sentence arbitrale correspondante.
7. Si certaines dispositions du présent contrat conclu avec le client, y compris les présentes conditions de livraison et de paiement, devaient s'avérer partiellement ou totalement nulles et non avenues, cela n'affectera en rien la validité des autres dispositions. La disposition partiellement ou totalement nulle et non avenue devra être remplacée par une disposition dont l'objectif économique se rapproche le plus possible de celui de la disposition invalidée.

**ROS**®

ROS CHIMNEYS, S.L.U.

Pol. Ind. Parc Pla, C/ Esparver Cendrós, s/n  
43810 El Pla de Santa Maria (Tarragona) - SPAIN  
Tel. +34 977 63 17 09 · Fax +34 977 63 17 10  
roschimneys@rostubos.com - www.rostubos.com



/rostubos



**Válido a partir de 05/2023**

**Valid from 05/2023**

**Valide à partir du 05/2023**

Salvo errores de imprenta, omisiones y modificaciones  
Except for printing errors, omissions and modifications  
*Sous réserve d'erreurs d'impression, omissions et modifications*

DISTRIBUIDOR | DISTRIBUTOR | *DISTRIBUTEUR* :

