

DUPLACH

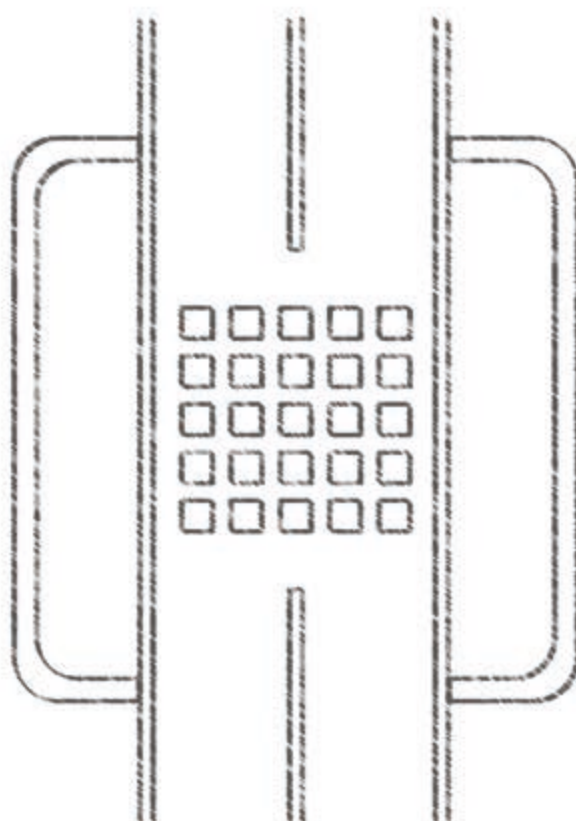

COLECCIÓN **PLATOS DE DUCHA**

DUPLACH

COLECCIÓN PLATOS DE DUCHA

ESP

Duplach Group es una empresa nacida en el año 2010 dedicada a la creación y fabricación de platos de ducha hechos con resina, cargas minerales y Gel Coat , y muebles de baño creados con madera, melaminas y 3D.

Nuestro principal objetivo es ofrecer diseño, calidad y precio, mejorando día tras día, es por ello que Duplach incorpora en su plantilla trabajadores dedicados personal y profesionalmente al trabajo que desempeñan con seriedad y puntualidad; siendo estas dos últimas nuestras prioridades, asignándose a cada uno, una tarea y una responsabilidad; complacer a cada uno de nuestros clientes.

En los últimos años Duplach Group ha cumplido con sus objetivos de crecimiento internacional con una implantación en más de 20 países: dentro de la UE, África, U.S.A y Canadá. Todo esto ha sido gracias a la confianza que nuestros clientes y equipo profesional depositan cada día en nosotros.

Desde nuestras modernas instalaciones de 10000 m2, en Duplach Group producimos platos de ducha y mobiliario de baño con la maquinaria más innovadora. Una empresa moderna y actual, que sigue los más altos estándares de calidad certificada ISO 9001 y es respetuosa con el medio ambiente según certificación ISO 14001.

Nuestra capacidad productiva nos permite responder a las demandas más exigentes, siendo nuestro cliente, nuestro mayor valor.

Fieles a la filosofía Kaizen, nuestra meta es la mejora continua.

ENG

Duplach Group is a duly established company born in 2010 dedicated to the creation and manufacture of shower trays made with resin, mineral fillers and Gel Coat. Duplach also produces bathroom furniture made from wood, melamine and a 3D print finishing.

Our main goal is to offer design, quality and price, improving day after day, that is why Duplach relies on a task force committed personally and professionally to the work they perform with seriousness and efficiency; these last two being our priorities, assigning each one tasks and responsibilities; To please every single customer.

Recently Duplach Group has met its international growth objectives with an implementation in more than 20 countries: within the EU, Africa, U.S.A and Canada. All this has been thanks to the trust that our clients and professional team place every day in us.

From our modern 10000 square metres facilities, at Duplach Group we produce shower trays and bathroom furniture with the most innovative machinery. A breakthrough and modern company, following the highest standards of ISO 9001 certified quality and is environmentally friendly according to ISO 14001 certification.

Our productive capacity allows us to give the most demanding requests response, being our client, our greatest value.

Faithful to Kaizen philosophy, our goal is continuous improvement.

FR

Duplach Group est une société née en 2010, dédiée à la création et à la fabrication de receveurs de douche en résine, de charges minérales et de Gel Coat, ainsi que de meubles de salle de bains en bois, mélamine et 3D.

Notre objectif principal est de proposer jour après jour design, qualité et prix, et c'est pourquoi Duplach incorpore dans son personnel des travailleurs dédiés personnellement et professionnellement au travail qu'ils effectuent avec sérieux et ponctualité; ces deux dernières étant nos priorités, assigner à chacune une tâche et une responsabilité; s'il vous plaît chacun de nos clients.

Au cours des dernières années, le groupe Duplach a atteint ses objectifs de croissance internationale avec une mise en œuvre dans plus de 20 pays: au sein de l'UE, en Afrique, aux États-Unis et au Canada. Tout cela grâce à la confiance que nos clients et notre équipe de professionnels placent chaque jour en nous.

Duplach Group fabrique des receveurs de douche et des meubles de salle de bains avec les machines les plus innovantes depuis ses installations modernes de 8 000 m2. Une entreprise moderne qui respecte les normes les plus élevées de qualité certifiée ISO 9001 et qui respecte l'environnement conformément à la certification ISO 14001.

Notre capacité de production nous permet de répondre aux demandes les plus exigeantes, en tant que client, notre plus grande valeur.

Fidèle à la philosophie Kaizen, notre objectif est l'amélioration continue.

IT

Duplach Group è una società nata nel 2010 dedicata alla creazione e produzione di piatti doccia, di materiale in resina, mineral marmo e Gel Coat, e mobili da bagno realizzati con legno, melamina e 3D.

Il nostro obiettivo principale è la ricerca de design, qual e prezzo, migliorando giorno dopo giorno, motivo per cui i dipendenti di Duplach sono professionisti dediati al lavoro che svolgono con serietà, assegando a ciascuno un compito e una responsabilità per soddisfare ogni richiesta di nostri clienti.

Negli ultimi anni il Gruppo Duplach ha raggiunto i suoi obiettivi di crescita internazionale con un'implementazione in oltre 20 paesi: all'interno dell'UE, Africa, Stati Uniti e Canada. Tutto ciò grazie alla fiducia dei nostri clienti e al team di professionisti che ci ha supportato ogni giorno.

Dalle nostre moderne strutture di 8000 m2, nel Gruppo Duplach produciamo piatti doccia e mobili da bagno con i macchinari più innovativi. Un'azienda moderna e attuale, con i più alti standard di qualità certificata ISO 9001 ed è ecologica secondo la certificazione ISO 14001.

La nostra capacità produttiva ci consente di rispondere alle richieste più esigenti, essendo il nostro cliente, il nostro più grande valore.

Fedele alla filosofia Kaizen, il nostro obiettivo è il miglioramento continuo.

DK

Duplach Group ist ein Unternehmen, das im Jahr 2010 gegründet wurde und sich der Herstellung von Duschwannen widmet, die aus Harz, mineralischen Füllstoffen und Gel Coat bestehen, sowie Badmöbel aus Holz, Melamin und 3D.

Unser Hauptziel ist es, Design, Qualität und Preis anzubieten und uns Tag für Tag zu verbessern, dies ist der Grund warum Duplach über Mitarbeiter verfügt die sich persönlich als auch professionell mit Zuverlässigkeit und Pünktlichkeit der Arbeit widmen ; wobei diese beiden letzten unsere Prioritäten sind, und jedem eine Aufgabe und Verantwortung zuweisen; um so jeden unserer Kunden zufriedenzustellen.

In den letzten Jahren hat die Duplach Group ihre internationalen Wachstumsziele mit einer Umsetzung in mehr als 20 Ländern erreicht: innerhalb der UE, Afrika, U.S.A und Kanada. All dies ist dem Vertrauen zu verdanken, das unsere Kunden und unser professionelles Team uns täglich entgegenbringen.

Aus unseren modernen 10.000m2 großen Anlagen produzieren wir bei Duplach Group Duschwannen und Badmöbel mit den innovativsten Maschinen. Ein modernes und aktuelles Unternehmen, das den höchsten Qualitätsstandards entspricht und nach ISO 9001 zertifiziert ist und gemäß der Zertifizierung nach ISO 14001 umweltbewusst ist.

Unsere Produktionskapazität ermöglicht es uns, auf die anspruchsvollsten Anforderungen unserer Kunden zu reagieren, wobei diese unser größtes Kapital sind. Getreu der Kaizen Philosophie ist unser Ziel die kontinuierliche Verbesserung.

INDICE · INDEX · INDICE · INDICE · INDEX

STONE PLUS 04 · 15

STONE SIDE 16 · 27

STONE MIO 28 · 39

STONE CACH 40 · 51

STONE SMART 52 · 63

STONE SORTY 64 · 75

STONE 3D 76 · 259

SOLUCIONES PARA BAÑO 260 · 245

BATHROOM SOLUTIONS · SOLUTIONS DE SALLE DE BAIN · SOLUZIONI PER IL BAGNO · BAD-LÖSUNGEN

CERTIFICADOS DE CALIDAD 246 · 247

QUALITY CERTIFICATES · CERTIFICATS DE QUALITÉ · CERTIFICATI DI QUALITÀ · QUALITÄT SZERTIFIKATE

MANUAL DE INSTALACIÓN 248 · 249

INSTALLATION MANUAL · INSTALLATION MANUEL · MANUALE DI INSTALLAZIONE · INSTALLATIONSANLEITUNGTE



El modelo Stone PLUS, se caracteriza por la simplicidad de sus líneas y su rejilla cuadrada.
Un plato sencillo y elegante.

The Stone PLUS model stands out for a neat design line and its square shape grid. Such a simple and stylish tray.

Le modèle Stone PLUS se caractérise par la simplicité de ses lignes et sa grille carrée.
Un receveur simple et élégant.

Il modello Stone PLUS è caratterizzato dalla semplicità delle sue linee e dalla sua griglia quadrata.
Un piatto semplice ed elegante.

Das Stone Plus Modell zeichnet sich durch die Einfachheit seiner Linien und seines quadratischen Gitters aus.
Eine einfache und elegante Duschwanne.

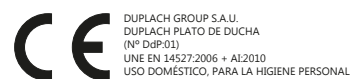

PLUS

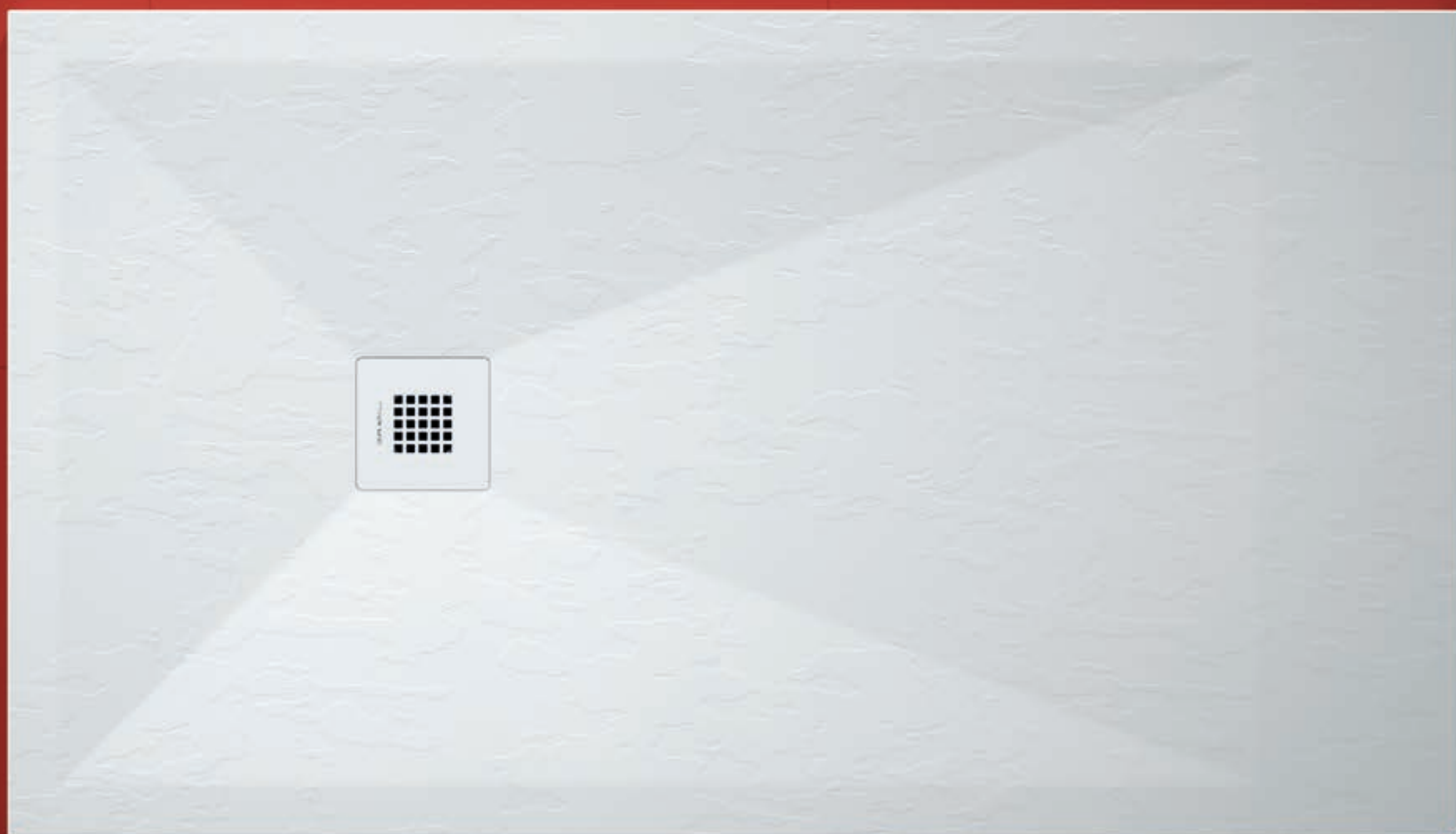



Moka · Moka · Moka · Moka · Mokka



Blanco · White · Blanc · Bianco · Weiß



Antracita · Anthracite · Anthracite · Antracite · Anthrazit



Arena · Sand · Sable · Sabbia · Sand



Crema · Cream · Crème · Crema · Creme



Gris 7035 · Gray 7035 · Gris 7035 · Griego 7035 · Grau 7035



Gris · Grav · Gris · Grigio · Grau



STONE PLUS

A
Hasta 100 cm. - 290 mm
Hasta 120 cm. - 290 mm
Hasta 140 cm. - 400 mm.
Hasta 150 cm. - 450 mm.
Hasta 160 cm. - 450 mm.
Hasta 180 cm. - 450 mm.
Hasta 210 cm. - 500 mm.

B y C = D/2

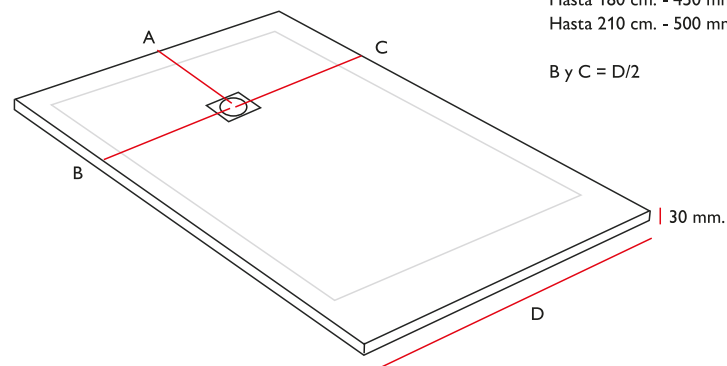

Nula absorción del agua.
Alta resistencia al rayado.
Dureza en la escala de Barcol de 45.
Resistente al cambio de temperatura.
Antideslizante.
Antibacterias.
Agentes químicos.
100% personalizable por el cliente.
Su grosor es de 3 cm.

Zero water absorption.
High scratch resistance.
Rated 45 on the Barcol hardness scale.
Resistant to temperature change.
Anti-slip.
Antibacterial
Resistant to chemical agents.
Fully customizable.
Its thickness is 3 cm width.

Pas d'absorption d'eau.
Haute résistance aux rayures.
Duréte sur l'échelle Barcol de 45.
Résistant au changement de température.
Antidérapant
Antibactérien
Agents chimiques.
100% personnalisable par le client.
Son épaisseur est de 3 cm.

Assorbimento nullo dell'acqua
Elevata resistenza al graffio
Scala di durezza di 45 barcol
Resistente alle variazioni di temperatura
Antiscivolo
Antibatterico
Resistente ai prodotti chimici
100% personalizzabile dal cliente
Il suo spessore è di 3 cm. Circa.

Keine Wasseraufnahme.
Hohe Kratzfestigkeit.
Härte auf der Barcolskala 45.
Beständig gegen Temperaturänderung.
Rutschfest.
Antibakteriell.
Beständig gegen chemische Mittel.
100% anpassbar durch den Kunden.
Seine Dicke beträgt 3 cm

DISEÑO · DESIGN · CONCEPTION · DISEGNO · DESIGN

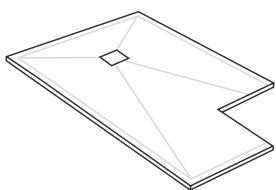

Adaptamos el diseño del plato a cualquier forma.
Incluido en precio.

Trays adaptable to non-standard shapes. Included in price.

Nous adaptons le design du plat à toutes les formes.
Inclus dans le prix.

Sagoniamo e adattiamo il piatto a qualsiasi richiesta.
Compreso nel prezzo.

Wir passen das Design der Duschwanne an jede Form an. Im Preis inbegriffen.

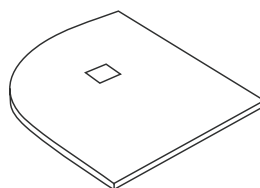

Medidas 80 y 90 incluidos con radio 50 cm.
Otras medidas y radios incremento de 50€ PVP.

Measures 80 and 90 along with radius 50 cm. Other measures and radii mean a € 50 sales price increase/each

Mesure 80 et 90 inclus avec un rayon de 50 cm.
Les autres mesures et rayon augmentent de 50 € Prix Public

Misure 80 e 90 comprese con raggio di 50 cm.
Altre misure e raggio aumento di € 50 PVP.

Radiuskurve von 50 cm bei den Maßen 80 cm und 90 cm ohne Aufpreis.
Andere Maße und Radius mit Aufpreis von 50 € Verkaufspreis

COLORES · COLOURS · COULEURS · COLORI · FARBEN

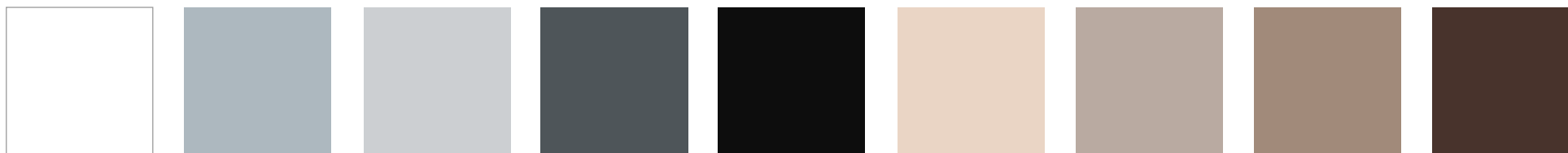

Blanco	Gris	Gris 7035	Antracita	Negro	Crema	Arena	Moka	Chocolate
White	Gray	Gray 7035	Anthracite	Black	Cream	Sand	Moka	Chocolate
Blanc	Gris	Gris 7035	Anthracite	Noir	Crème	Sable	Moka	Chocolat
Bianco	Grigio	Grigio 7035	Antracite	Nero	Crema	Sabbia	Moka	Cioccolato
Weiß	Grau	Grau 7035	Anthrazit	Schwarz	Crema	Sand	Mokka	Schokobraun

La fabricación se realiza con la masa coloreada en los tonos de nuestra carta de color. Podemos realizar la pieza en cualquier color de la carta RAL con incremento.

Los productos realizados con colores diferentes a los de nuestra carta de color están exentos de devolución.

La fabrication se fait avec la masse colorée dans les teintes de notre nuancier. Nous pouvons réaliser la pièce dans n'importe quelle couleur de la carte RAL avec incrément.

Les produits fabriqués avec des couleurs différentes de notre nuancier sont exemptés de retour.

Die Herstellung erfolgt mit dem Teig, der in den Tönen unserer Farbkarte gefärbt ist. Wir können das Stück auch in jeder Farbe des RAL – Diagramms mit Aufpreis herstellen.

Produkte, die mit anderen als den in unserer Farbkarte aufgeführten Farben hergestellt wurden, sind von Rücksendungen ausgenommen.

Manufacturing comes with a colored mass as from our colour chart. Trays produced in any different colour within the RAL chart entail a subsequent price increase.

Products made with colours other than our colour chart ones can not be returned

La produzione viene eseguita con la massa colorata nelle tonalità della nostra cartella colori. Possiamo realizzare il pezzo in qualsiasi colore della carta RAL con incremento.

Il prodotti realizzati con colori diversi rispetto alla nostra cartella colori sono esenti dalla restituzione.

TEXTURAS · TEXTURES
TEXTURES · STRUTTURE · TEXTUR



Liso	Pizarra
Smooth	Slate
Lisse	Ardoise
Liscio	Ardesia
Glatt	Strukturiert

REJILLA · GRID
GRILLE · GRIGLIA · GITTER

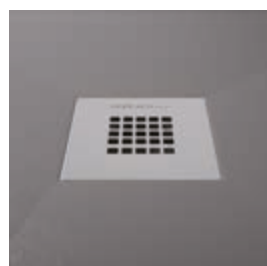

Rejilla Acero Inox. Incluida en precio
Grid Stainless Steel Included in price
Grille Acier Inoxydable Inclus dans le prix
Griglia Acciaio Inox. Compresa nel prezzo
Edelstahlgitter im Preis inbegriffen

Opcional · Optional
En Option · Opzional · Optional

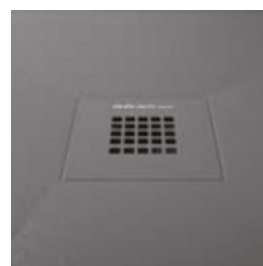

Rejilla a color Incluida en precio
Color Grid Included in price
Grille de couleur Inclus dans le prix
Griglia dei colori Compresa nel prezzo
Farbgitter im Preis inbegriffen

VÁLVULA · WASTE BONDE ·
VALVOLA · VENTIL



Válvula 90. Incluida en precio
Waste 90. Included in price
Bonde 90. Inclus dans le prix
Valvola 90. Compresa nel prezzo
Ventil 90. Im preis inbegriffen

El modelo Stone SIDE, suma originalidad a la gama Stone gracias a la pendiente centrada y a la rejilla rectangular del diseño.

The Stone SIDE model adds originality to the range Stone thanks to the centered slope and to its rectangular design grid.

Le modèle Stone SIDE ajoute de l'originalité à la gamme Stone grâce à la pente centrée et à sa grille de conception rectangulaire.

Il modello Stone SIDE aggiunge originalità alla serie Stone grazie alla pendenza centrata e alla sua griglia di disegno rettangolare.

Das Stone SIDE Modell verleiht dem Stone Sortiment dank der zentrierten Neigung und des rechteckigen Gitters des Designs Originalität.

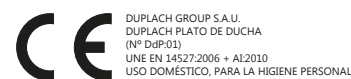

SIDE

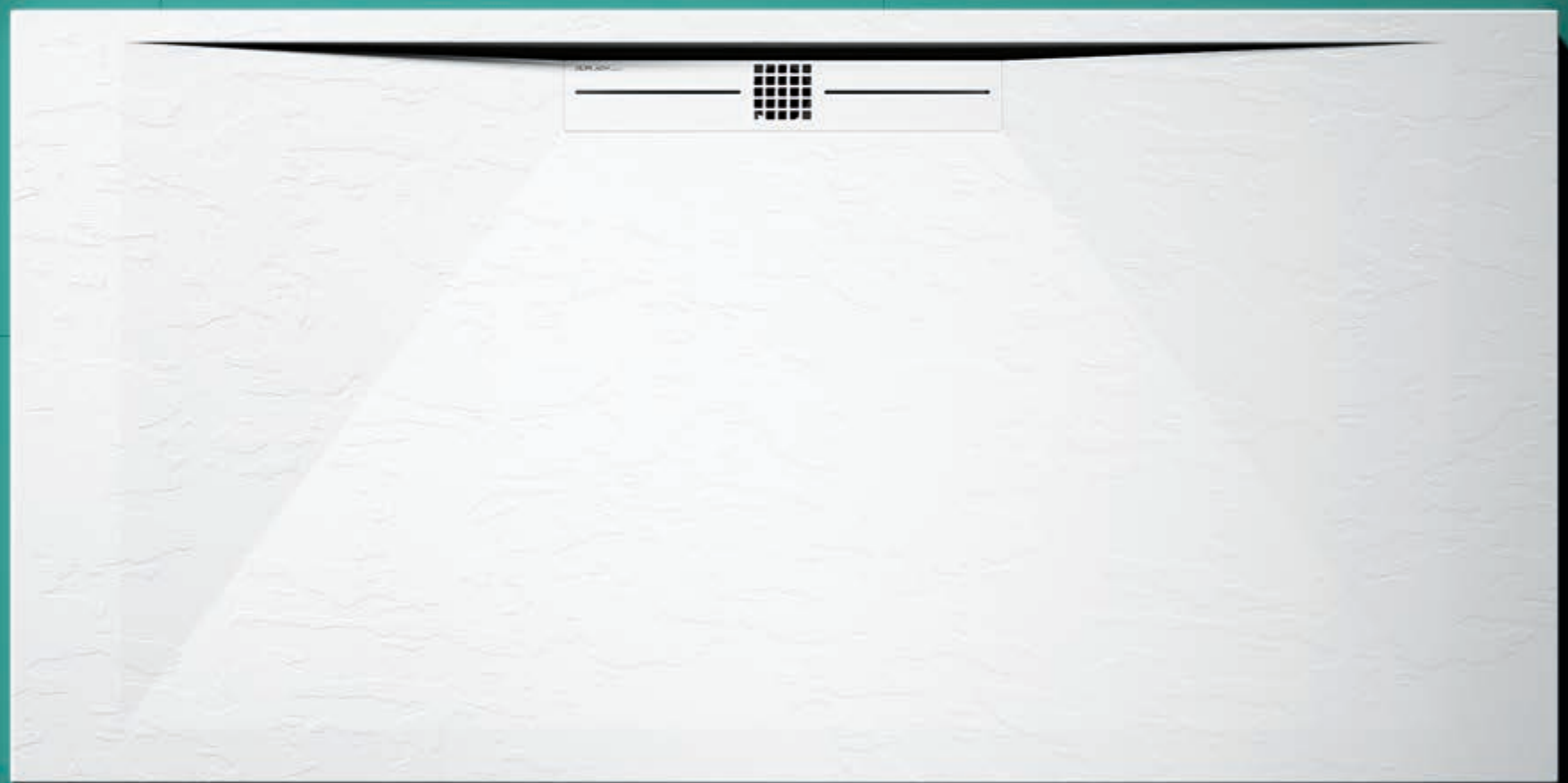



Negro · Black · Noir · Nero · Schwarz



Arena · Sand · Sable · Sabbia · Sand



Blanco · White · Blanc · Bianco · Weiß



Gris 7035 · Gray 7035 · Gris 7035 · Griego 7035 · Grau 7035





Blanco · White · Blanc · Bianco · Weiß



Antracita · Anthracite · Anthracite · Antracite · Anthrazit



STONE SIDE

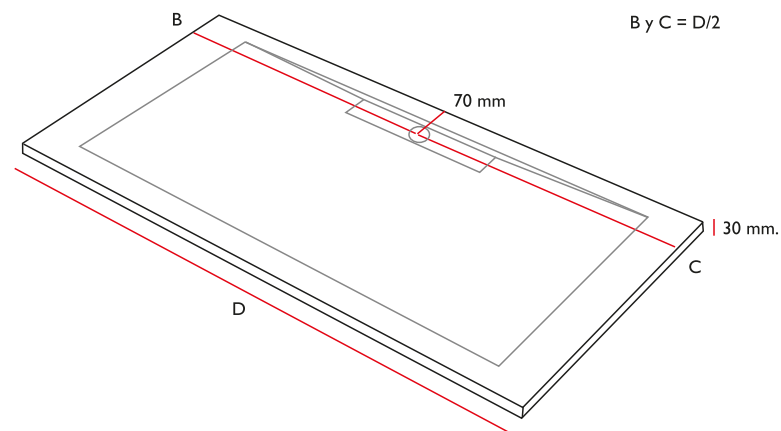

Nula absorción del agua.
Alta resistencia al rayado.
Dureza en la escala de Barcol de 45.
Resistente al cambio de temperatura.
Antideslizante.
Antibacterias.
Agentes químicos.
100% personalizable por el cliente.
Su grosor es de 3 cm.

Zero water absorption.
High scratch resistance.
Rated 45 on the Barcol hardness scale.
Resistant to temperature change.
Anti-slip.
Antibacterial
Resistant to chemical agents.
Fully customizable.
Its thickness is 3 cm width.

Pas d'absorption d'eau.
Haute résistance aux rayures.
Dureté sur l'échelle Barcol de 45.
Résistant au changement de température.
Antidérapant
Antibactérien
Agents chimiques.
100% personnalisable par le client.
Son épaisseur est de 3 cm.

Assorbimento nullo dell'acqua
Elevata resistenza al graffio
Scala di durezza di 45 barcol
Resistente alle variazioni di temperatura
Antiscivolo
Antibatterico
Resistente ai prodotti chimici
100% personalizzabile dal cliente
Il suo spessore è di 3 cm. Circa.

Keine Wasseraufnahme.
Hohe Kratzfestigkeit.
Härte auf der Barcolskala 45.
Beständig gegen Temperaturänderung.
Rutschfest.
Antibakteriell.
Beständig gegen chemische Mittel.
100% anpassbar durch den Kunden.
Seine Dicke beträgt 3 cm

DISEÑO · DESIGN · CONCEPTION · DISEGNO · DESIGN

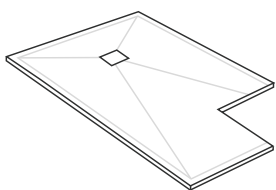

Adaptamos el diseño del plato a cualquier forma.
Incluido en precio.

Trays adaptable to non-standard shapes. Included in price.

Nous adaptons le design du plat à toutes les formes.
Inclus dans le prix.

Sagoniamo e adattiamo il piatto a qualsiasi richiesta.
Compreso nel prezzo.

Wir passen das Design der Duschwanne an jede Form an. Im Preis inbegriffen.

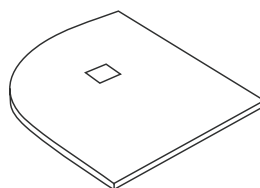

Medidas 80 y 90 incluidos con radio 50 cm.
Otras medidas y radios incremento de 50€ PVP.

Measures 80 and 90 along with radius 50 cm. Other measures and radii mean a € 50 sales price increase/each

Mesure 80 et 90 inclus avec un rayon de 50 cm.
Les autres mesures et rayon augmentent de 50 € Prix Public

Misure 80 e 90 comprese con raggio di 50 cm.
Altre misure e raggio aumento di € 50 PVP.

Radiuskurve von 50 cm bei den Maßen 80 cm und 90 cm ohne Aufpreis.
Andere Maße und Radius mit Aufpreis von 50 € Verkaufspreis

COLORES · COLOURS · COULEURS · COLORI · FARBEN

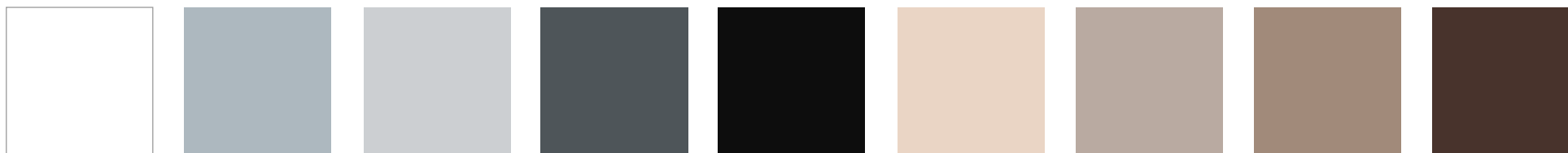

Blanco	Gris	Gris 7035	Antracita	Negro	Crema	Arena	Moka	Chocolate
White	Gray	Gray 7035	Anthracite	Black	Cream	Sand	Moka	Chocolate
Blanc	Gris	Gris 7035	Anthracite	Noir	Crème	Sable	Moka	Chocolat
Bianco	Grigio	Grigio 7035	Antracite	Nero	Crema	Sabbia	Moka	Cioccolato
Weiß	Grau	Grau 7035	Anthrazit	Schwarz	Crema	Sand	Mokka	Schokobraun

La fabricación se realiza con la masa coloreada en los tonos de nuestra carta de color. Podemos realizar la pieza en cualquier color de la carta RAL con incremento.

Los productos realizados con colores diferentes a los de nuestra carta de color están exentos de devolución.

La fabrication se fait avec la masse colorée dans les teintes de notre nuancier. Nous pouvons réaliser la pièce dans n'importe quelle couleur de la carte RAL avec incrément.

Les produits fabriqués avec des couleurs différentes de notre nuancier sont exemptés de retour.

Die Herstellung erfolgt mit dem Teig, der in den Tönen unserer Farbkarte gefärbt ist. Wir können das Stück auch in jeder Farbe des RAL – Diagramms mit Aufpreis herstellen.

Produkte, die mit anderen als den in unserer Farbkarte aufgeführten Farben hergestellt wurden, sind von Rücksendungen ausgenommen.

Manufacturing comes with a colored mass as from our colour chart. Trays produced in any different colour within the RAL chart entail a subsequent price increase.

Products made with colours other than our colour chart ones can not be returned

La produzione viene eseguita con la massa colorata nelle tonalità della nostra cartella colori. Possiamo realizzare il pezzo in qualsiasi colore della carta RAL con incremento.

Il prodotti realizzati con colori diversi rispetto alla nostra cartella colori sono esenti dalla restituzione.

TEXTURAS · TEXTURES
TEXTURES · STRUTTURE · TEXTUR



Liso	Pizarra
Smooth	Slate
Lisse	Ardoise
Liscio	Ardesia
Glatt	Strukturiert

REJILLA · GRID
GRILLE · GRIGLIA · GITTER



Rejilla Acero Inox. Incluida en precio
Grid Stainless Steel Included in price
Grille Acier Inoxydable Inclus dans le prix
Griglia Acciaio Inox. Compresa nel prezzo
Edelstahlgitter im Preis inbegriffen

Opcional · Optional
En Option · Opzional · Optional



Rejilla a color Incluida en precio
Color Grid Included in price
Grille de couleur Inclus dans le prix
Griglia dei colori Compresa nel prezzo
Farbgitter im Preis inbegriffen

VÁLVULA · WASTE BONDE ·
VALVOLA · VENTIL



Válvula 60. Incluida en precio
Waste 60. Included in price
Bonde 60. Inclus dans le prix
Valvola 60. Compresa nel prezzo
Ventil 60. Im preis inbegriffen

El modelo Stone MIO, otra incorporación a la gama Stone, nuevas líneas y rejilla en esquina que hacen este modelo singular y único.

The Stone MIO model, another addition to the Stone range. New lines and a corner grid making this model unique and exclusive

Le modèle Stone MIO, un autre ajout à la gamme La pierre, les nouvelles lignes et la grille d'angle rendent ce modèle unique.

Il modello Stone MIO, un'altra aggiunta alla serie STONE, nuove linee e griglia angolare che rendono questo modello unico e singolare.

Das Stone MIO Modell, eine weitere Ergänzung der Stone Reihe, neue Linien und Eckgitter, die dieses Modell einzigartig machen.

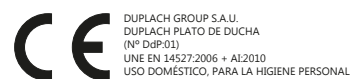

MiO

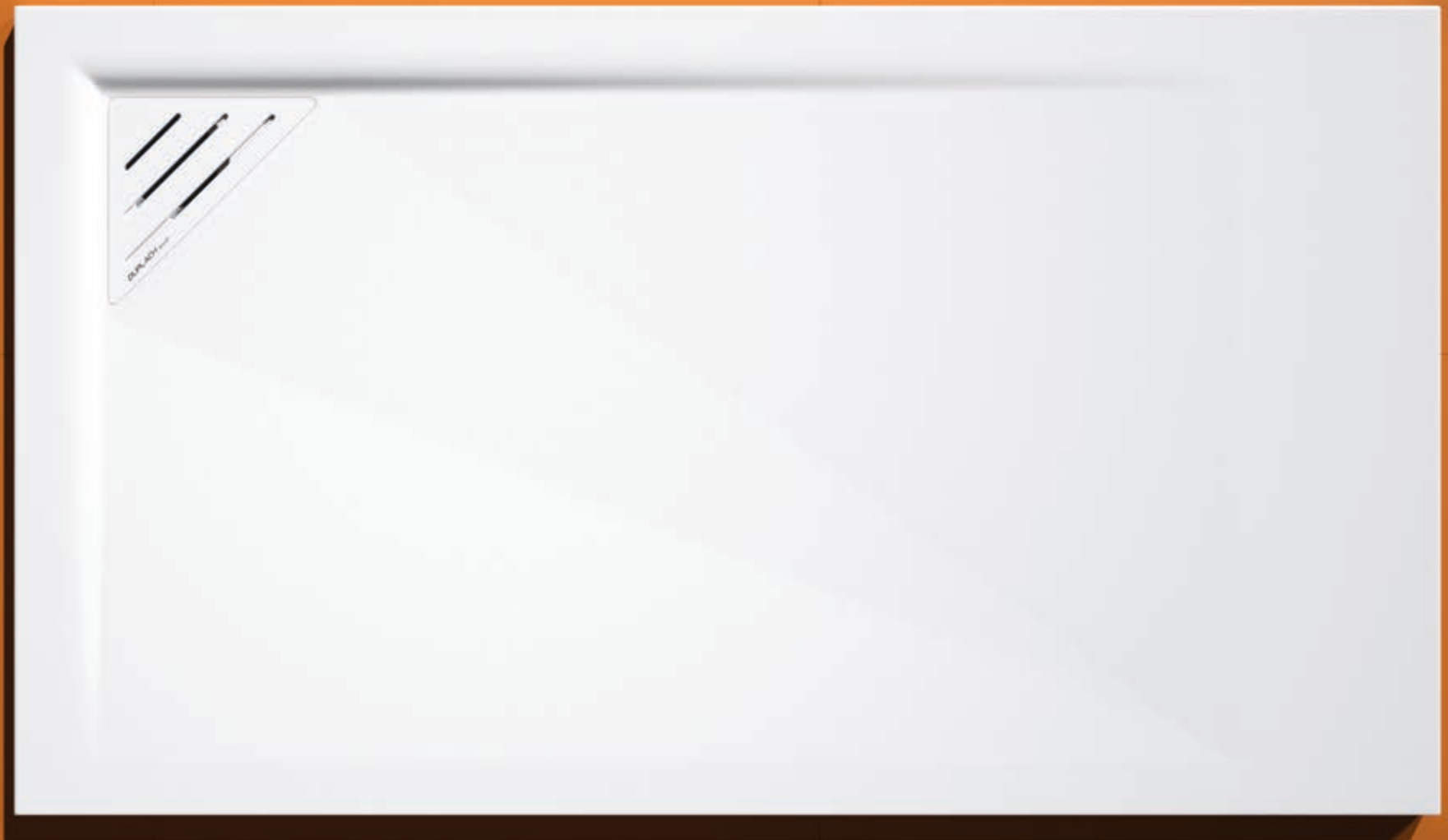

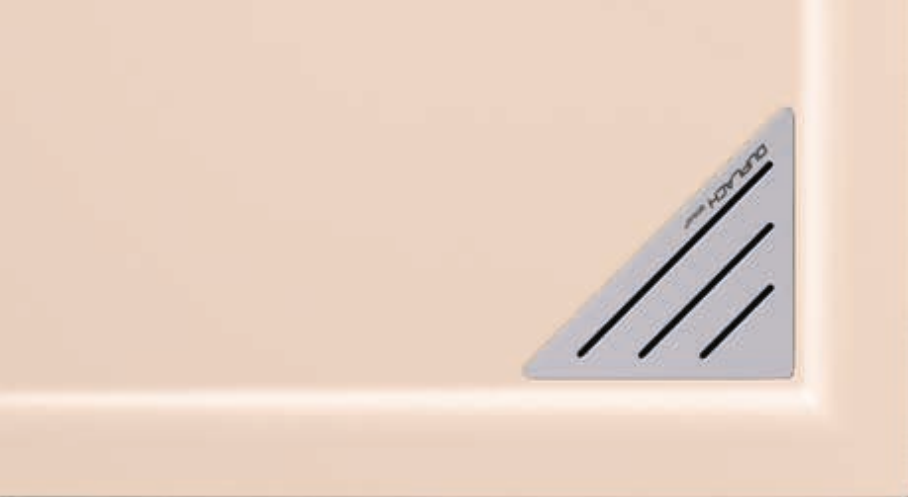



Moka · Moka · Moka · Moka · Mokka



Gris 7035 · Gray 7035 · Gris 7035 · Grigio 7035 · Grau 7035



Antracita · Anthracite · Anthracite · Antracite · Anthrazit



Chocolate · Chocolate · Chocolat · Cioccolato · Schokobraun



Arena · Sand · Sable · Sabbia · Sand



Blanco · White · Blanc · Bianco · Weiß



STONE MIO

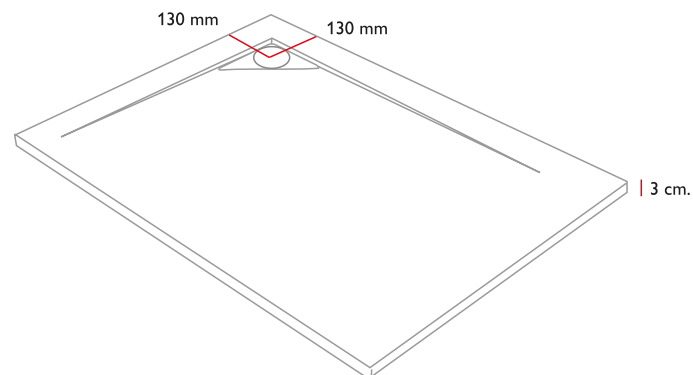

Nula absorción del agua.
Alta resistencia al rayado.
Dureza en la escala de Barcol de 45.
Resistente al cambio de temperatura.
Antideslizante.
Antibacterias.
Agentes químicos.
100% personalizable por el cliente.
Su grosor es de 3 cm.

Zero water absorption.
High scratch resistance.
Rated 45 on the Barcol hardness scale.
Resistant to temperature change.
Anti-slip.
Antibacterial
Resistant to chemical agents.
Fully customizable.
Its thickness is 3 cm width.

Pas d'absorption d'eau.
Haute résistance aux rayures.
Dureté sur l'échelle Barcol de 45.
Résistant au changement de température.
Antidérapant
Antibactérien
Antichimiques.
100% personnalisable par le client.
Son épaisseur est de 3 cm.

Assorbimento nullo dell'acqua
Elevata resistenza al graffio
Scala di durezza di 45 barcol
Resistente alle variazioni di temperatura
Antiscivolo
Antibatterico
Resistente ai prodotti chimici
100% personalizzabile dal cliente
Il suo spessore è di 3 cm. Circa.

Keine Wasseraufnahme.
Hohe Kratzfestigkeit.
Härte auf der Barcolskala 45.
Beständig gegen Temperaturänderung.
Rutschfest.
Antibakteriell.
Beständig gegen chemische Mittel.
100% anpassbar durch den Kunden.
Seine Dicke beträgt 3 cm

DISEÑO · DESIGN · CONCEPTION · DISEGNO · DESIGN

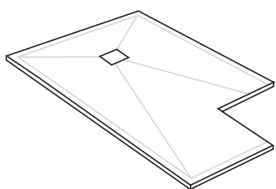

Adaptamos el diseño del plato a cualquier forma.
Incluido en precio.

Trays adaptable to non-standard shapes. Included in price.

Nous adaptons le design du plat à toutes les formes.
Inclus dans le prix.

Sagoniamo e adattiamo il piatto a qualsiasi richiesta.
Compreso nel prezzo.

Wir passen das Design der Duschwanne an jede Form an. Im Preis inbegriffen.

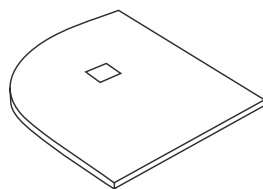

Medidas 80 y 90 incluidos con radio 50 cm.
Otras medidas y radios incremento de 50€ PVP.

Measures 80 and 90 along with radius 50 cm. Other measures and radios mean a € 50 sales price increase/each

Mesure 80 et 90 inclus avec un rayon de 50 cm.
Les autres mesures et rayon augmentent de 50 € Prix Public

Misure 80 e 90 comprese con raggio di 50 cm.
Altre misure e raggio aumento di € 50 PVP.

Radiuskurve von 50 cm bei den Maßen 80 cm und 90 cm ohne Aufpreis.

Andere Maße und Radius mit Aufpreis von 50 € Verkaufspreis

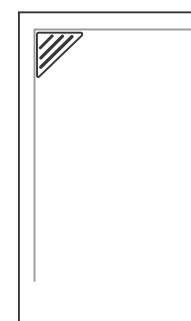

Izquierda · Left
Gauche · Sinistra

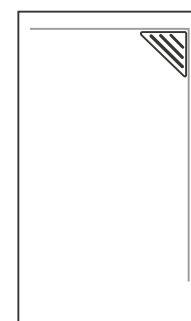

Derecha · Right
Droite · Destra

El modelo Mio se puede fabricar en ambos sentidos, derecha e izquierda.

The Mio model can be manufactured in both Senses, right and left.

Le modèle Mio peut être fabriqué dans les deux Sens, droite et gauche.

Il modello Mio può essere prodotto in entrambi Sensi, destra e sinistra.

Das MIO Modell kann rechts sowie links hergestellt werden.

COLORES · COLOURS · COULEURS · COLORI · FARBEN

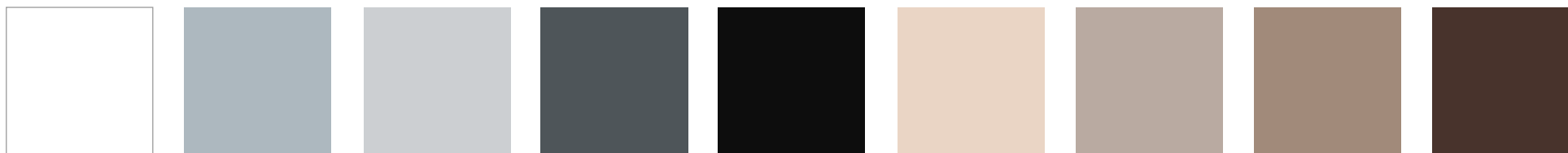

Blanco	Gris	Gris 7035	Antracita	Negro	Crema	Arena	Moka	Chocolate
White	Gray	Gray 7035	Anthracite	Black	Cream	Sand	Moka	Chocolate
Blanc	Gris	Gris 7035	Anthracite	Noir	Crème	Sable	Moka	Chocolat
Bianco	Grigio	Grigio 7035	Antracite	Nero	Crema	Sabbia	Moka	Cioccolato
Weiß	Grau	Grau 7035	Anthrazit	Schwarz	Crema	Sand	Mokka	Schokobraun

La fabricación se realiza con la masa coloreada en los tonos de nuestra carta de color. Podemos realizar la pieza en cualquier color de la carta RAL con incremento.

Los productos realizados con colores diferentes a los de nuestra carta de color están exentos de devolución.

La fabrication se fait avec la masse colorée dans les teintes de notre nuancier. Nous pouvons réaliser la pièce dans n'importe quelle couleur de la carte RAL avec incrément.

Les produits fabriqués avec des couleurs différentes de notre nuancier sont exemptés de retour.

Die Herstellung erfolgt mit dem Teig, der in den Tönen unserer Farbkarte gefärbt ist. Wir können das Stück auch in jeder Farbe des RAL – Diagramms mit Aufpreis herstellen.

Produkte, die mit anderen als den in unserer Farbkarte aufgeführten Farben hergestellt wurden, sind von Rücksendungen ausgenommen.

Manufacturing comes with a colored mass as from our colour chart. Trays produced in any different colour within the RAL chart entail a subsequent price increase.

Products made with colours other than our colour chart ones can not be returned

La produzione viene eseguita con la massa colorata nelle tonalità della nostra cartella colori. Possiamo realizzare il pezzo in qualsiasi colore della carta RAL con incremento.

Il prodotti realizzati con colori diversi rispetto alla nostra cartella colori sono esenti dalla restituzione.

TEXTURAS · TEXTURES
TEXTURES · STRUTTURE · TEXTUR

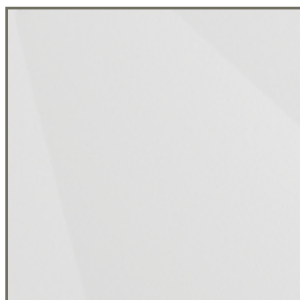

Liso
Smooth
Lisse
Liscio
Glatt

REJILLA · GRID
GRILLE · GRIGLIA · GITTER



Rejilla Acero Inox. Incluida en precio
Grid Stainless Steel Included in price
Grille Acier Inoxydable Inclus dans le prix
Griglia Acciaio Inox. Compresa nel prezzo
Edelstahlgitter im Preis inbegriffen

Opcional · Optional
En Option · Opzional · Optional



Rejilla a color Incluida en precio
Color Grid Included in price
Grille de couleur Inclus dans le prix
Griglia dei colori Compresa nel prezzo
Farbgitter im Preis inbegriffen

VÁLVULA · WASTE BONDE ·
VALVOLA · VENTIL



Válvula 90. Incluida en precio
Waste 90. Included in price
Bonde 90. Inclus dans le prix
Valvola 90. Compresa nel prezzo
Ventil 90. Im preis inbegriffen

El modelo Stone CACH, un marco con suave degradado y una rejilla rectangular dotan a este modelo de un carácter propio.

In the Stone SMART model, the mimicked rectangular grid next to the degraded tray frame, grade design to the highest level.

Le modèle Stone CACH, un cadre légèrement dégradé et une grille rectangulaire confèrent à ce modèle son caractère propre.

Il modello Stone CACH, una cornice con pendenza dolce e una griglia rettangolare forniscono questo modello il suo carattere.

Das Stone CACH Modell, ein Rahmen mit sanften Verlauf und einem rechteckigem Gitter verleihen diesem Modell seinen eigenen Charakter.

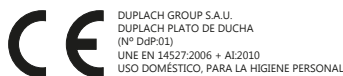

CACH

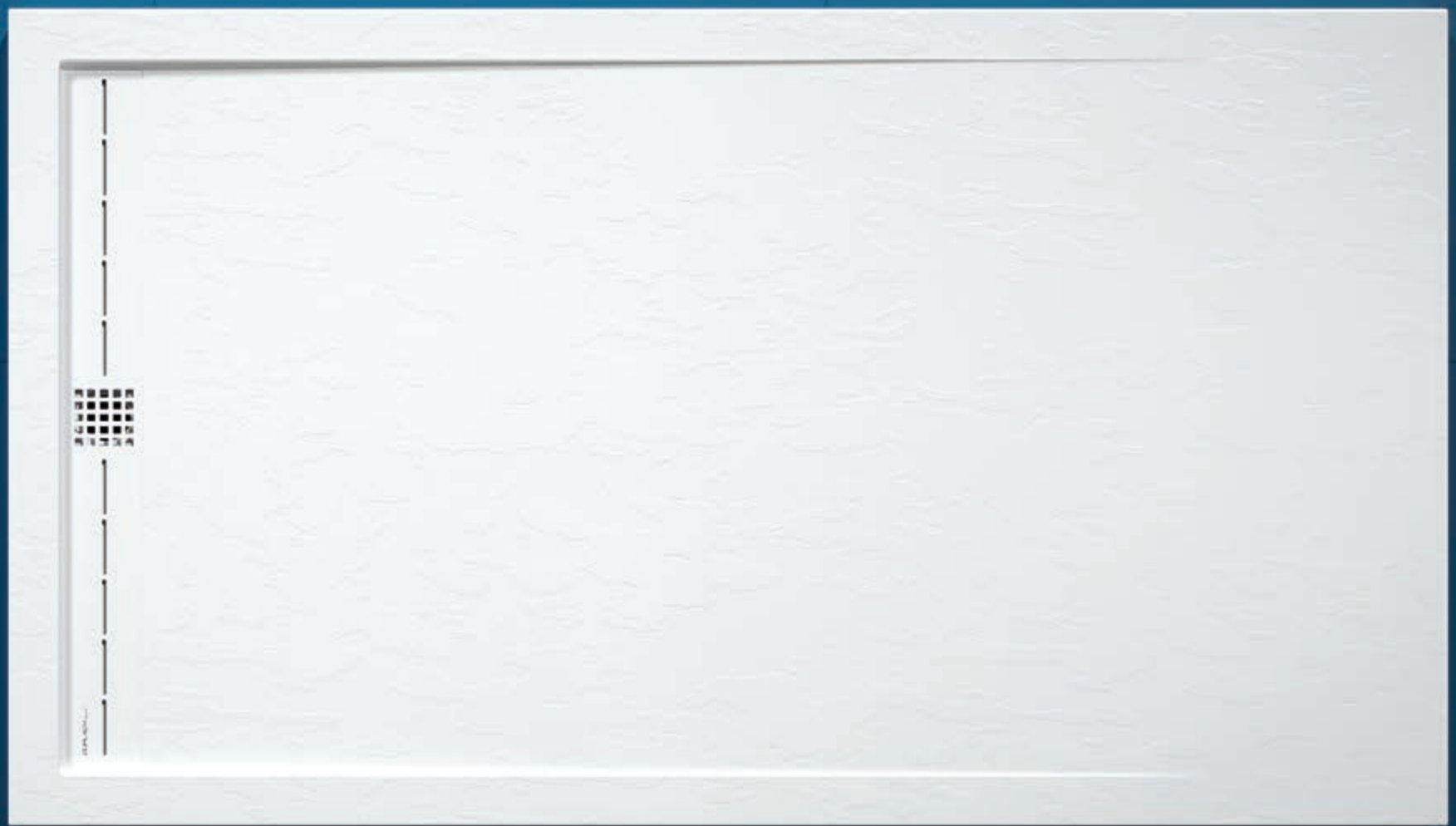



Antracita · Anthracite · Anthracite · Antracite · Anthrazit

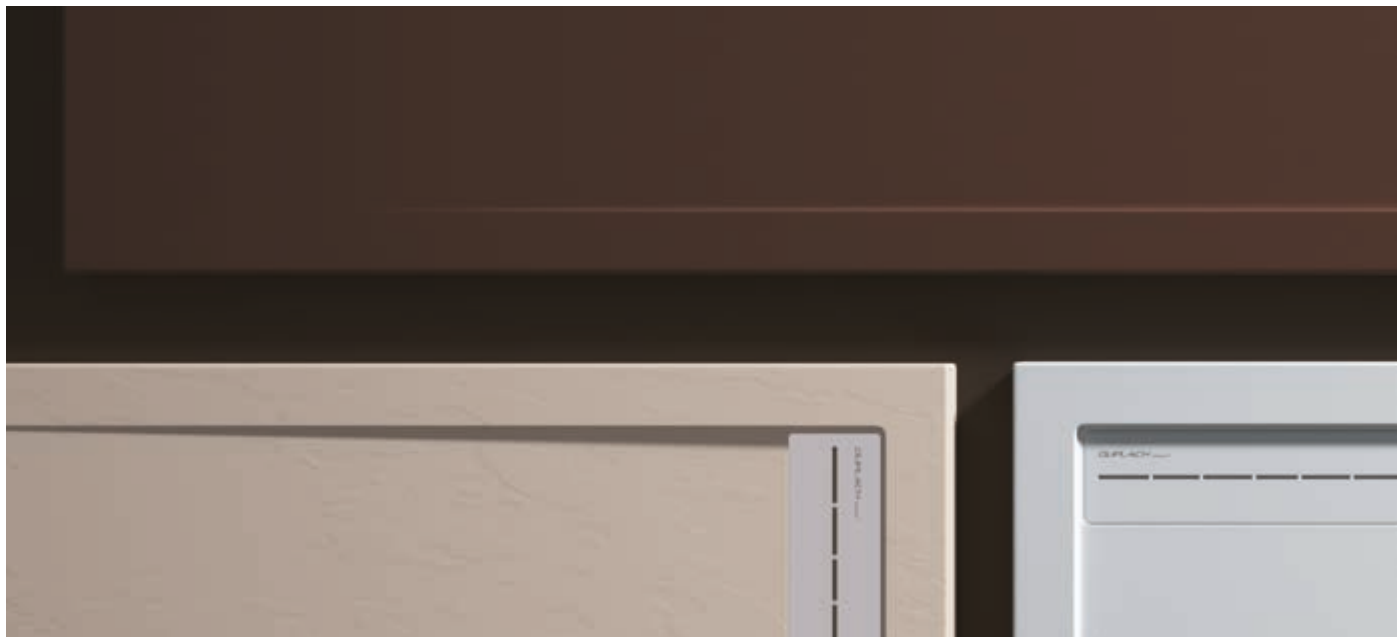



Crema · Cream · Crème · Crema · Creme





Blanco · White · Blanc · Bianco · Weiß



Moka · Moka · Moka · Moka · Mokka



Arena · Sand · Sable · Sabbia · Sand



Gris 7035 · Gray 7035 · Gris 7035 · Grigio 7035 · Grau 7035



Gris · Gray · Gris · Grigio · Grau



STONE CACH

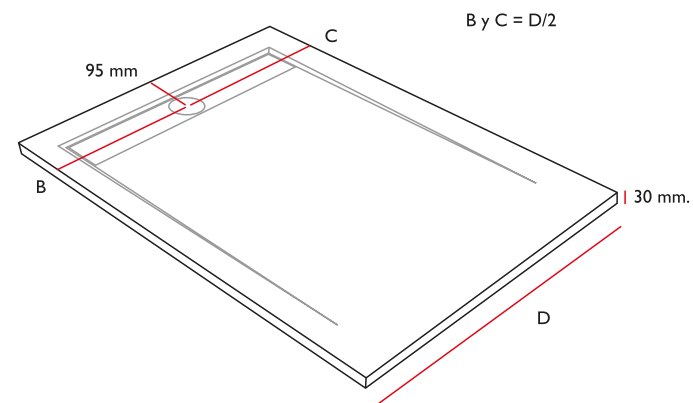

Nula absorción del agua.
Alta resistencia al rayado.
Dureza en la escala de Barcol de 45.
Resistente al cambio de temperatura.
Antideslizante.
Antibacterias.
Agentes químicos.
100% personalizable por el cliente.
Su grosor es de 3 cm.

Zero water absorption.
High scratch resistance.
Rated 45 on the Barcol hardness scale.
Resistant to temperature change.
Anti-slip.
Antibacterial
Resistant to chemical agents.
Fully customizable.
Its thickness is 3 cm width.

Pas d'absorption d'eau.
Haute résistance aux rayures.
Dureté sur l'échelle Barcol de 45.
Résistant au changement de température.
Antidérapant
Antibactérien
Agents chimiques.
100% personnalisable par le client.
Son épaisseur est de 3 cm.

Assorbimento nullo dell'acqua
Elevata resistenza al graffio
Scala di durezza di 45 barcol
Resistente alle variazioni di temperatura
Antiscivolo
Antibatterico
Resistente ai prodotti chimici
100% personalizzabile dal cliente
Il suo spessore è di 3 cm. Circa.

Keine Wasseraufnahme.
Hohe Kratzfestigkeit.
Härte auf der Barcolskala 45.
Beständig gegen Temperaturänderung.
Rutschfest.
Antibakteriell.
Beständig gegen chemische Mittel.
100% anpassbar durch den Kunden.
Seine Dicke beträgt 3 cm

DISEÑO · DESIGN · CONCEPTION · DISEGNO · DESIGN

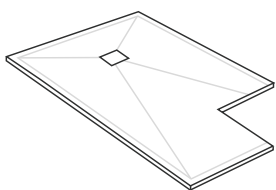

Adaptamos el diseño del plato a cualquier forma.
Incluido en precio.

Trays adaptable to non-standard shapes. Included in price.

Nous adaptons le design du plat à toutes les formes.
Inclus dans le prix.

Sagoniamo e adattiamo il piatto a qualsiasi richiesta.
Compreso nel prezzo.

Wir passen das Design der Duschwanne an jede Form an. Im Preis inbegriffen.

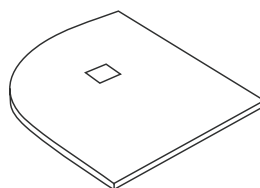

Medidas 80 y 90 incluidos con radio 50 cm.
Otras medidas y radios incremento de 50€ PVP.

Measures 80 and 90 along with radius 50 cm. Other measures and radii mean a € 50 sales price increase/each

Mesure 80 et 90 inclus avec un rayon de 50 cm.
Les autres mesures et rayon augmentent de 50 € Prix Public

Misure 80 e 90 comprese con raggio di 50 cm.
Altre misure e raggio aumento di € 50 PVP.

Radiuskurve von 50 cm bei den Maßen 80 cm und 90 cm ohne Aufpreis.
Andere Maße und Radius mit Aufpreis von 50 € Verkaufspreis

COLORES · COLOURS · COULEURS · COLORI · FARBEN

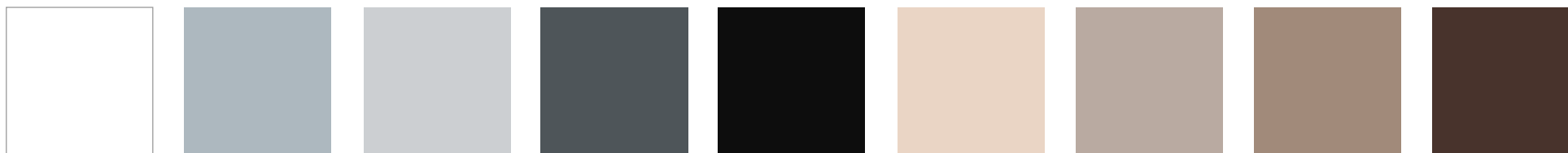

Blanco	Gris	Gris 7035	Antracita	Negro	Crema	Arena	Moka	Chocolate
White	Gray	Gray 7035	Anthracite	Black	Cream	Sand	Moka	Chocolate
Blanc	Gris	Gris 7035	Anthracite	Noir	Crème	Sable	Moka	Chocolat
Bianco	Grigio	Grigio 7035	Antracite	Nero	Crema	Sabbia	Moka	Cioccolato
Weiß	Grau	Grau 7035	Anthrazit	Schwarz	Crema	Sand	Mokka	Schokobraun

La fabricación se realiza con la masa coloreada en los tonos de nuestra carta de color. Podemos realizar la pieza en cualquier color de la carta RAL con incremento.

Los productos realizados con colores diferentes a los de nuestra carta de color están exentos de devolución.

La fabrication se fait avec la masse colorée dans les teintes de notre nuancier. Nous pouvons réaliser la pièce dans n'importe quelle couleur de la carte RAL avec incrément.

Les produits fabriqués avec des couleurs différentes de notre nuancier sont exemptés de retour.

Die Herstellung erfolgt mit dem Teig, der in den Tönen unserer Farbkarte gefärbt ist. Wir können das Stück auch in jeder Farbe des RAL – Diagramms mit Aufpreis herstellen.

Produkte, die mit anderen als den in unserer Farbkarte aufgeführten Farben hergestellt wurden, sind von Rücksendungen ausgenommen.

Manufacturing comes with a colored mass as from our colour chart. Trays produced in any different colour within the RAL chart entail a subsequent price increase.

Products made with colours other than our colour chart ones can not be returned

La produzione viene eseguita con la massa colorata nelle tonalità della nostra cartella colori. Possiamo realizzare il pezzo in qualsiasi colore della carta RAL con incremento.

Il prodotti realizzati con colori diversi rispetto alla nostra cartella colori sono esenti dalla restituzione.

TEXTURAS · TEXTURES
TEXTURES · STRUTTURE · TEXTUR



Liso	Pizarra
Smooth	Slate
Lisse	Ardoise
Liscio	Ardesia
Glatt	Strukturiert

REJILLA · GRID
GRILLE · GRIGLIA · GITTER



Rejilla Acero Inox. Incluida en precio
Grid Stainless Steel Included in price
Grille Acier Inoxydable Inclus dans le prix
Griglia Acciaio Inox. Compresa nel prezzo
Edelstahlgitter im Preis inbegriffen

Opcional · Optional
En Option · Opzional · Optional



Rejilla a color Incluida en precio
Color Grid Included in price
Grille de couleur Inclus dans le prix
Griglia dei colori Compresa nel prezzo
Farbgitter im Preis inbegriffen

VÁLVULA · WASTE BONDE ·
VALVOLA · VENTIL



Válvula 60. Incluida en precio
Waste 60. Included in price
Bonde 60. Inclus dans le prix
Valvola 60. Compresa nel prezzo
Ventil 60. Im preis inbegriffen

En el modelo Stone SMART, la rejilla rectangular mi-
metizada junto al marco degradado del plato, elevan el
diseño a la máxima potencia.

In the Stone SMART model, the rectangular grille ca-
mouflaged together with the degraded frame of the tray,
elevate the design to its maximum power.

Dans le modèle Stone SMART, la grille rectangulaire
imitée située à côté du cadre de plaque dégradé élève le
design à une puissance maximale.

Nel modello Stone SMART, la griglia rettangolare imita la
struttura a gradiente del piatto, elevando il disegno alla
massima potenza.

Beim Stone SMART Modell imitiert das rechteckige Gitter,
das zusammen mit dem sanften Verlauf des
Rahmens, das Design auf maximale Leistung.

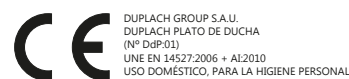

SMART

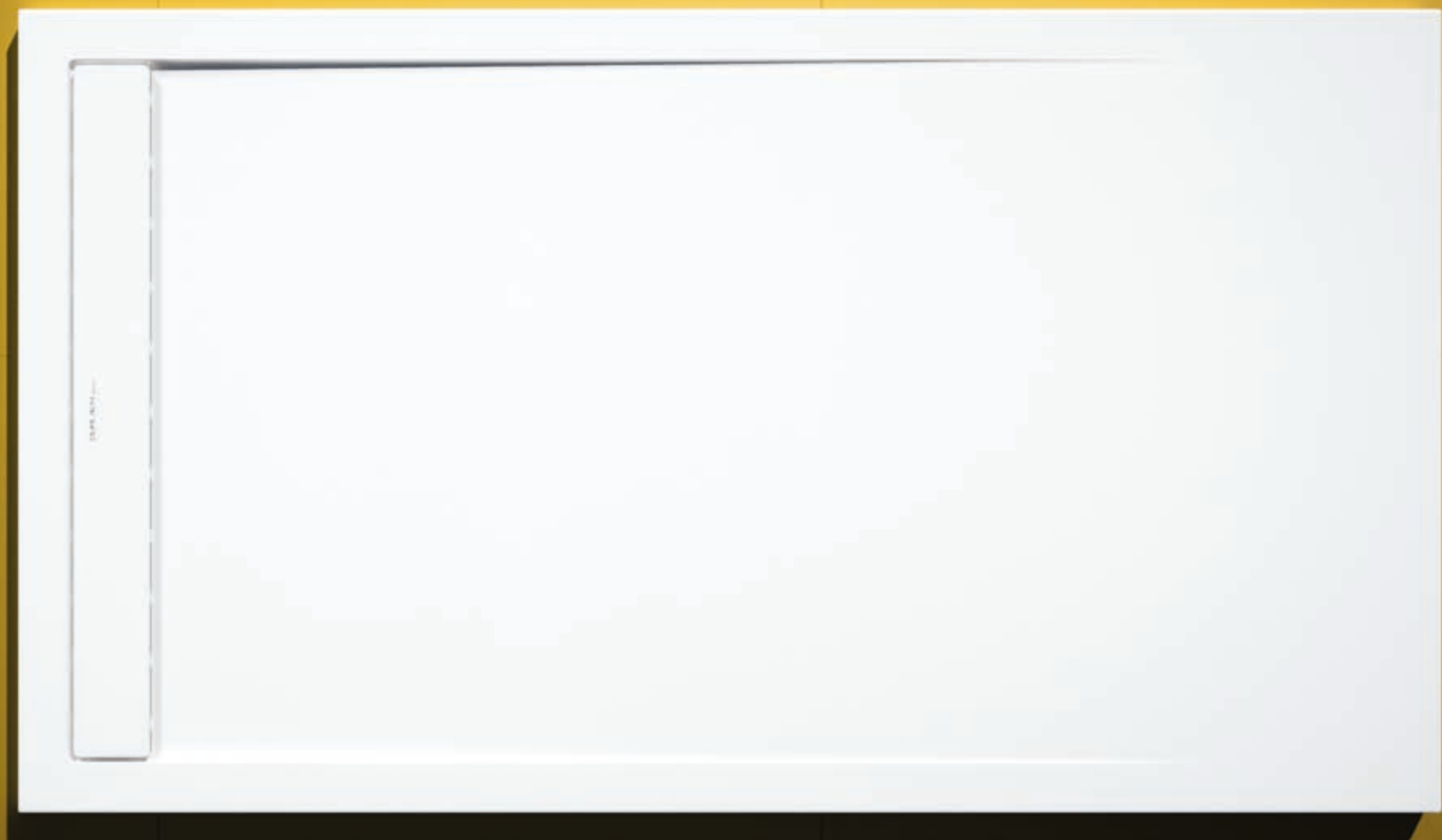



Crema · Cream · Crème · Crema · Creme



Negro · Black · Noir · Nero · Schwarz





Gris 7035 · Gray 7035 · Gris 7035 · Grigio 7035 · Grau 7035



Blanco · White · Blanc · Bianco · Weiß



Arena · Sand · Sable · Sabbia · Sand



Antracita · Anthracite · Anthracite · Antracite · Anthrazit



STONES SMART

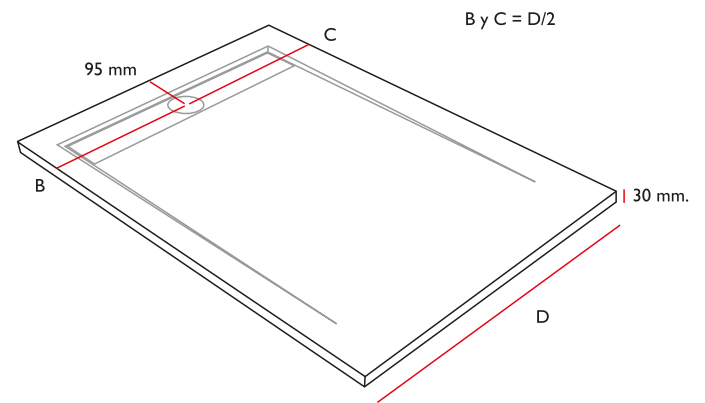

Nula absorción del agua.
Alta resistencia al rayado.
Dureza en la escala de Barcol de 45.
Resistente al cambio de temperatura.
Antideslizante.
Antibacterias.
Agentes químicos.
100% personalizable por el cliente.
Su grosor es de 3 cm.

Zero water absorption.
High scratch resistance.
Rated 45 on the Barcol hardness scale.
Resistant to temperature change.
Anti-slip.
Antibacterial
Resistant to chemical agents.
Fully customizable.
Its thickness is 3 cm width.

Pas d'absorption d'eau.
Haute résistance aux rayures.
Dureté sur l'échelle Barcol de 45.
Résistant au changement de température.
Antidérapant
Antibactérien
Agents chimiques.
100% personnalisable par le client.
Son épaisseur est de 3 cm.

Assorbimento nullo dell'acqua
Elevata resistenza al graffio
Scala di durezza di 45 barcol
Resistente alle variazioni di temperatura
Antiscivolo
Antibatterico
Resistente ai prodotti chimici
100% personalizzabile dal cliente
Il suo spessore è di 3 cm. Circa.

Keine Wasseraufnahme.
Hohe Kratzfestigkeit.
Härte auf der Barcolskala 45.
Beständig gegen Temperaturänderung.
Rutschfest.
Antibakteriell.
Beständig gegen chemische Mittel.
100% anpassbar durch den Kunden.
Seine Dicke beträgt 3 cm

DISEÑO · DESIGN · CONCEPTION · DISEGNO · DESIGN

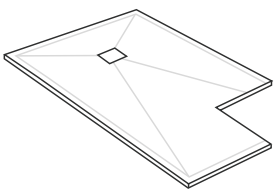

Adaptamos el diseño del plato a cualquier forma.
Incluido en precio.

Trays adaptable to non-standard shapes. Included in price.

Nous adaptons le design du plat à toutes les formes.
Inclus dans le prix.

Sagoniamo e adattiamo il piatto a qualsiasi richiesta.
Compreso nel prezzo.

Wir passen das Design der Duschwanne an jede Form an. Im Preis inbegriffen.

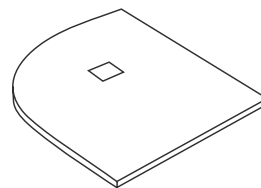

Medidas 80 y 90 incluidos con radio 50 cm.
Otras medidas y radios incremento de 50€ PVP.

Measures 80 and 90 along with radius 50 cm. Other measures and radii mean a € 50 sales price increase/each

Mesure 80 et 90 inclus avec un rayon de 50 cm.
Les autres mesures et rayon augmentent de 50 € Prix Public

Misure 80 e 90 comprese con raggio di 50 cm.
Altre misure e raggio aumento di € 50 PVP.

Radiuskurve von 50 cm bei den Maßen 80 cm und 90 cm ohne Aufpreis.
Andere Maße und Radius mit Aufpreis von 50 € Verkaufspreis

COLORES · COLOURS · COULEURS · COLORI · FARBEN

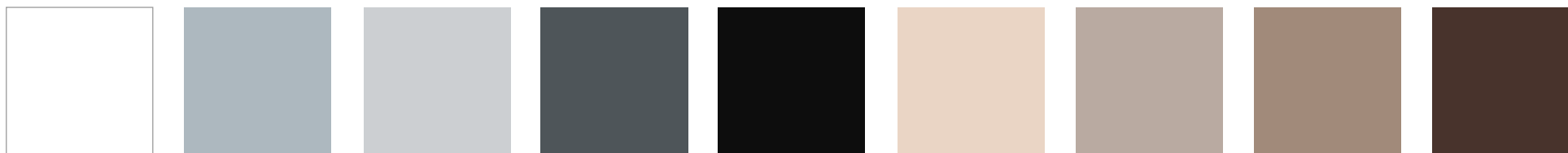

Blanco	Gris	Gris 7035	Antracita	Negro	Crema	Arena	Moka	Chocolate
White	Gray	Gray 7035	Anthracite	Black	Cream	Sand	Moka	Chocolate
Blanc	Gris	Gris 7035	Anthracite	Noir	Crème	Sable	Moka	Chocolat
Bianco	Grigio	Grigio 7035	Antracite	Nero	Crema	Sabbia	Moka	Cioccolato
Weiß	Grau	Grau 7035	Anthrazit	Schwarz	Crema	Sand	Mokka	Schokobraun

La fabricación se realiza con la masa coloreada en los tonos de nuestra carta de color. Podemos realizar la pieza en cualquier color de la carta RAL con incremento.

Los productos realizados con colores diferentes a los de nuestra carta de color están exentos de devolución.

La fabrication se fait avec la masse colorée dans les teintes de notre nuancier. Nous pouvons réaliser la pièce dans n'importe quelle couleur de la carte RAL avec incrément.

Les produits fabriqués avec des couleurs différentes de notre nuancier sont exemptés de retour.

Die Herstellung erfolgt mit dem Teig, der in den Tönen unserer Farbkarte gefärbt ist. Wir können das Stück auch in jeder Farbe des RAL – Diagramms mit Aufpreis herstellen.

Produkte, die mit anderen als den in unserer Farbkarte aufgeführten Farben hergestellt wurden, sind von Rücksendungen ausgenommen.

Manufacturing comes with a colored mass as from our colour chart. Trays produced in any different colour within the RAL chart entail a subsequent price increase.

Products made with colours other than our colour chart ones can not be returned

La produzione viene eseguita con la massa colorata nelle tonalità della nostra cartella colori. Possiamo realizzare il pezzo in qualsiasi colore della carta RAL con incremento.

Il prodotti realizzati con colori diversi rispetto alla nostra cartella colori sono esenti dalla restituzione.

TEXTURAS · TEXTURES
TEXTURES · STRUTTURE · TEXTUR



Liso	Pizarra
Smooth	Slate
Lisse	Ardoise
Liscio	Ardesia
Glatt	Strukturiert

REJILLA · GRID
GRILLE · GRIGLIA · GITTER

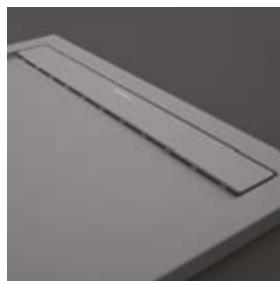

Rejilla a color Incluida en precio
Color Grid Included in price
Grille de couleur Inclus dans le prix
Griglia dei colori Compresa nel prezzo
Farbgitter im Preis inbegriffen

VÁLVULA · WASTE BONDE ·
VALVOLA · VENTIL



Válvula 60. Incluida en precio
Waste 60. Included in price
Bonde 60. Inclus dans le prix
Valvola 60. Compresa nel prezzo
Ventil 60. Im preis inbegriffen

En el modelo Stone SORTY, la rejilla centrada y de diseño más suavizado dotan a este plato de una estética y funcionalidad únicos.

In the Stone SORTY model, the centered grid and a smoother design give this tray a unique aesthetic and functionality.

Dans le modèle Stone SORTY, la grille centrée et un design plus lisse confèrent à ce plateau une esthétique et une fonctionnalité uniques.

Nel modello Stone SORTY, la griglia centrata e un design più liscio conferiscono a questo vassoio un'estetica e una funzionalità uniche.

Beim Modell Stone SORTY verleihen das zentrierte Gitter und ein glatteres Design diesem Tablett eine einzigartige Ästhetik und Funktionalität.

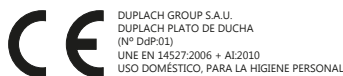

SORTY

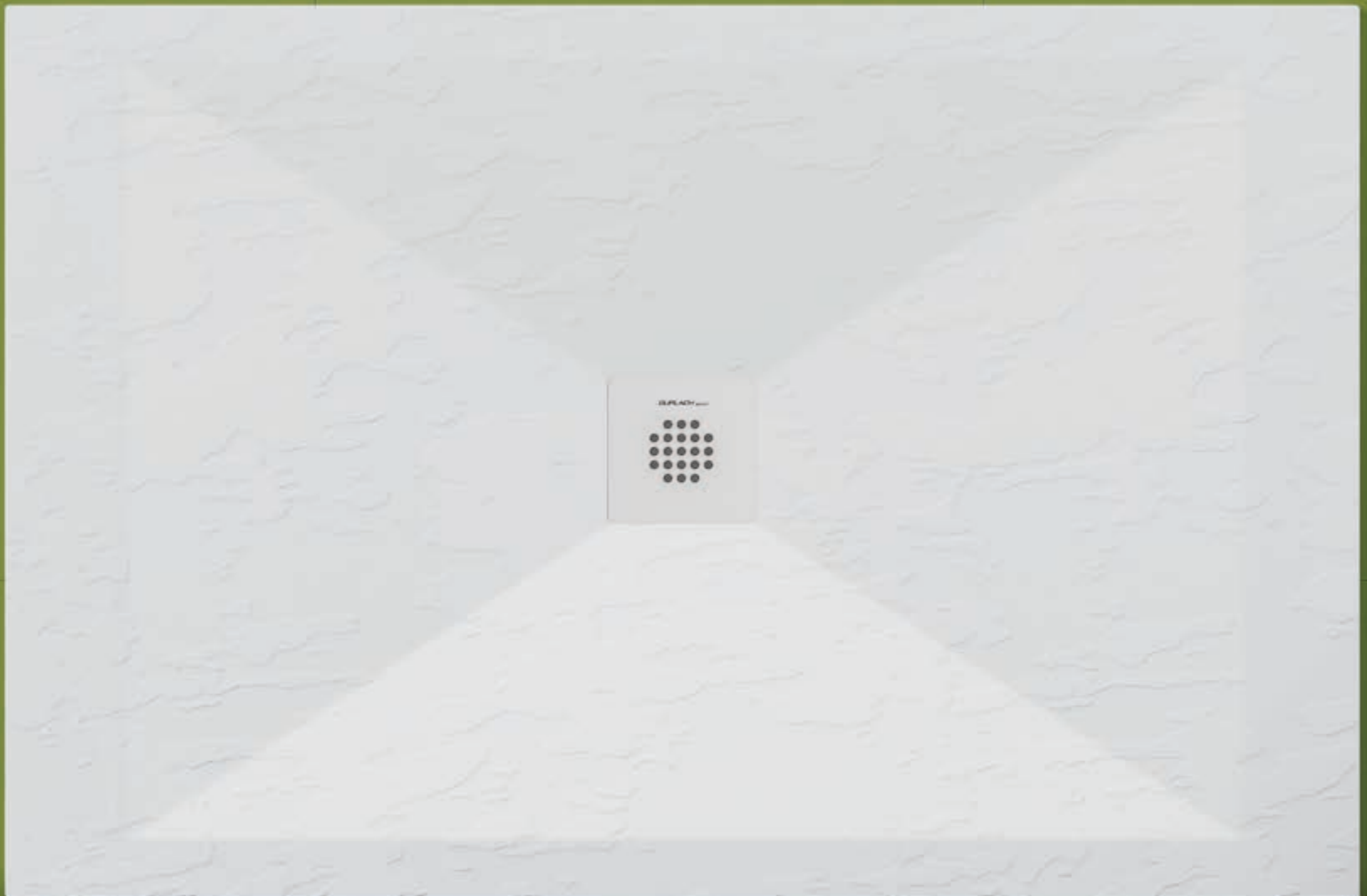



Blanco · White · Blanc · Bianco · Weiß



Negro · Black · Noir · Nero · Schwarz



Antracita · Anthracite · Anthracite · Antracite · Anthrazit





Moka · Moka · Moka · Moka · Mokka



Chocolate · Chocolate · Chocolat · Cioccolato · Schokobraun



Gris 7035 · Gray 7035 · Gris 7035 · Grigio 7035 · Grau 7035



Arena · Sand · Sable · Sabbia · Sand

STONE SORTY

$$A = E/2$$

$$B \text{ y } C = D/2$$

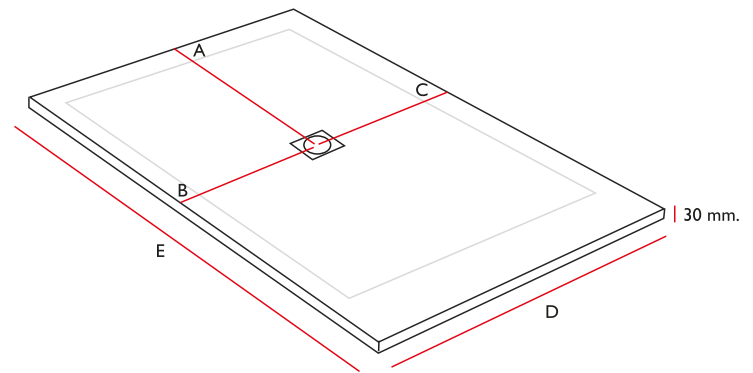

Nula absorción del agua.
Alta resistencia al rayado.
Dureza en la escala de Barcol de 45.
Resistente al cambio de temperatura.
Antideslizante.
Antibacterias.
Agentes químicos.
100% personalizable por el cliente.
Su grosor es de 3 cm.

Zero water absorption.
High scratch resistance.
Rated 45 on the Barcol hardness scale.
Resistant to temperature change.
Anti-slip.
Antibacterial
Resistant to chemical agents.
Fully customizable.
Its thickness is 3 cm width.

Pas d'absorption d'eau.
Haute résistance aux rayures.
Duréte sur l'échelle Barcol de 45.
Résistant au changement de température.
Antidérapant
Antibactérien
Agents chimiques.
100% personnalisable par le client.
Son épaisseur est de 3 cm.

Assorbimento nullo dell'acqua
Elevata resistenza al graffio
Scala di durezza di 45 barcol
Resistente alle variazioni di temperatura
Antiscivolo
Antibatterico
Resistente ai prodotti chimici
100% personalizzabile dal cliente
Il suo spessore è di 3 cm. Circa.

Keine Wasseraufnahme.
Hohe Kratzfestigkeit.
Härte auf der Barcolskala 45.
Beständig gegen Temperaturänderung.
Rutschfest.
Antibakteriell.
Beständig gegen chemische Mittel.
100% anpassbar durch den Kunden.
Seine Dicke beträgt 3 cm

DISEÑO · DESIGN · CONCEPTION · DISEGNO · DESIGN

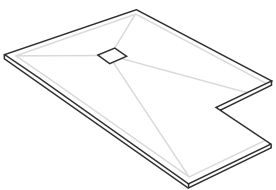

Adaptamos el diseño del plato a cualquier forma.
Incluido en precio.

Trays adaptable to non-standard shapes. Included in price.

Nous adaptons le design du plat à toutes les formes.
Inclus dans le prix.

Sagoniamo e adattiamo il piatto a qualsiasi richiesta.
Compreso nel prezzo.

Wir passen das Design der Duschwanne an jede Form an. Im Preis inbegriffen.

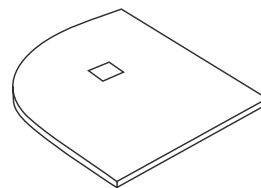

Medidas 80 y 90 incluidos con radio 50 cm.
Otras medidas y radios incremento de 50€ PVP.

Measures 80 and 90 along with radius 50 cm. Other measures and radii mean a € 50 sales price increase/each

Mesure 80 et 90 inclus avec un rayon de 50 cm.
Les autres mesures et rayon augmentent de 50 € Prix Public

Misure 80 e 90 comprese con raggio di 50 cm.
Altre misure e raggio aumento di € 50 PVP.

Radiuskurve von 50 cm bei den Maßen 80 cm und 90 cm ohne Aufpreis.
Andere Maße und Radius mit Aufpreis von 50 € Verkaufspreis

COLORES · COLOURS · COULEURS · COLORI · FARBEN

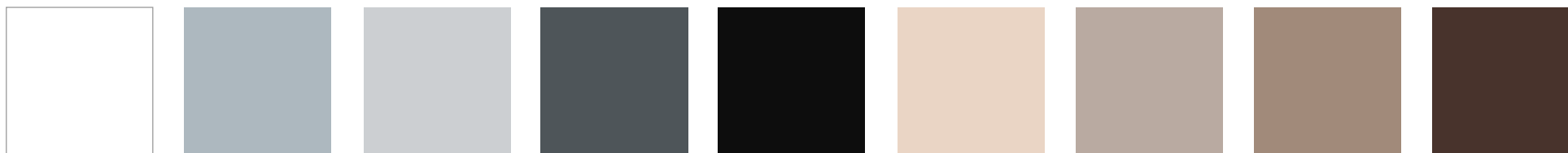

Blanco	Gris	Gris 7035	Antracita	Negro	Crema	Arena	Moka	Chocolate
White	Gray	Gray 7035	Anthracite	Black	Cream	Sand	Moka	Chocolate
Blanc	Gris	Gris 7035	Anthracite	Noir	Crème	Sable	Moka	Chocolat
Bianco	Grigio	Grigio 7035	Antracite	Nero	Crema	Sabbia	Moka	Cioccolato
Weiß	Grau	Grau 7035	Anthrazit	Schwarz	Crema	Sand	Mokka	Schokobraun

La fabricación se realiza con la masa coloreada en los tonos de nuestra carta de color. Podemos realizar la pieza en cualquier color de la carta RAL con incremento.

Los productos realizados con colores diferentes a los de nuestra carta de color están exentos de devolución.

La fabrication se fait avec la masse colorée dans les teintes de notre nuancier. Nous pouvons réaliser la pièce dans n'importe quelle couleur de la carte RAL avec incrément.

Les produits fabriqués avec des couleurs différentes de notre nuancier sont exemptés de retour.

Die Herstellung erfolgt mit dem Teig, der in den Tönen unserer Farbkarte gefärbt ist. Wir können das Stück auch in jeder Farbe des RAL – Diagramms mit Aufpreis herstellen.

Produkte, die mit anderen als den in unserer Farbkarte aufgeführten Farben hergestellt wurden, sind von Rücksendungen ausgenommen.

Manufacturing comes with a colored mass as from our colour chart. Trays produced in any different colour within the RAL chart entail a subsequent price increase.

Products made with colours other than our colour chart ones can not be returned

La produzione viene eseguita con la massa colorata nelle tonalità della nostra cartella colori. Possiamo realizzare il pezzo in qualsiasi colore della carta RAL con incremento.

Il prodotti realizzati con colori diversi rispetto alla nostra cartella colori sono esenti dalla restituzione.

TEXTURAS · TEXTURES
TEXTURES · STRUTTURE · TEXTUR

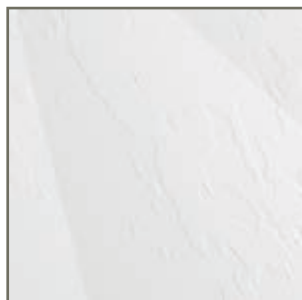

Pizarra
Slate
Ardoise
Ardesia
Strukturiert

REJILLA · GRID
GRILLE · GRIGLIA · GITTER



Rejilla Acero Inox. Incluida en precio
Grid Stainless Steel Included in price
Grille Acier Inoxydable Inclus dans le prix
Griglia Acciaio Inox. Compresa nel prezzo
Edelstahlgitter im Preis inbegriffen

Opcional · Optional
En Option · Opzional · Optional



Rejilla a color Incluida en precio
Color Grid Included in price
Grille de couleur Inclus dans le prix
Griglia dei colori Compresa nel prezzo
Farbgitter im Preis inbegriffen

VÁLVULA · WASTE BONDE ·
VALVOLA · VENTIL



Válvula 90. Incluida en precio
Waste 90. Included in price
Bonde 90. Inclus dans le prix
Valvola 90. Compresa nel prezzo
Ventil 90. Im preis inbegriffen

DUPLACH CREADORA DEL DISEÑO DIGITAL SOBRE PLATO DE DUCHA EN 2016.

El Stone 3D presenta la línea más creativa, permitiendo simular materiales nobles, acabados industriales y diseños abstractos...creando un baño único.



Oficina Española
de Marcas y Patentes

Diseños Patentados

CERTIFICADO-TÍTULO DE REGISTRO
INDUSTRIAL Nº 0526147

DUPLACH CREATOR OF THE
DIGITAL DESIGN ON SHOWER
TRAY IN 2016.

Stone 3D presents
the most creative line,
allowing the simulation of
noble materials, industrial
finishes, abstract designs...
creating a unique
bathroom.

DUPLACH CRÉATEUR DU
DESIGN DIGITAL SUR RECEVEUR
DE DOUCHE EN 2016.

Stone 3D présente la
ligne la plus créative,
permettant la simulation
de matériaux nobles, de
finitions industrielles, de
designs abstraits... créant
une salle de bain unique.

DUPLACH CREATORE DEL
DISEGNO DIGITALE SUL PIATTO
DOCCIA NEL 2016.

Stone 3D presenta la
linea più creativa, con-
sentendo la simulazione
di materiali nobili, finiture
industriali, disegni astratti...
creando un bagno
unico.

DUPLACH ERSTELLER DES
DIGITALEN DESIGNS AUF DUS-
CHWANNE IM JAHR 2016.

Stone 3D präsentiert die
kreativste Linie, die die
Simulation edler Materialien,
industrieller Oberflächen,
abstrakter Designs ermöglicht ...
und ein einzigartiges Badezimmer
schafft.



DUPLACH GROUP S.A.U.
DUPLACH PLATO DE DUCHA
(Nº DdP:01)
UNE EN 14527:2006 + A1:2010
USO DOMÉSTICO, PARA LA HIGIENE PERSONAL



EXCELENCIA
INTERNACIONAL
200 EFQM
EFQM
QUALIFIED BY
EFQM 2022

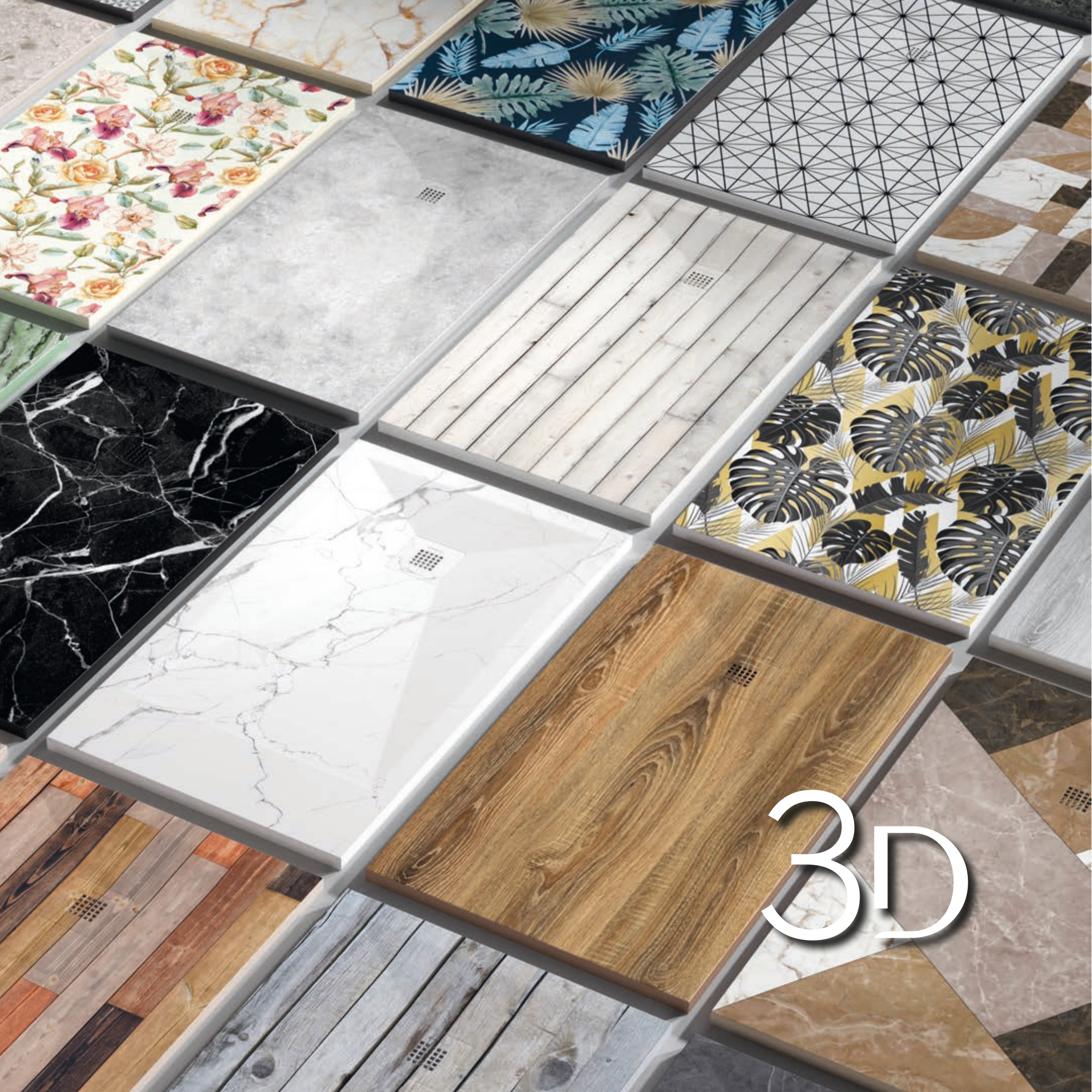

3D



78 · 79



YOUR SHOWER
YOUR MOMENT



Roble · Oak · Chêne · Quercia · Eiche



Ceniza · Ash · Cendre · Cenere · Asche



Vintage · Vintage · Vintage · Vintage · Vintage



Nogal · Walnut · Noyer · Noce · Walnuss



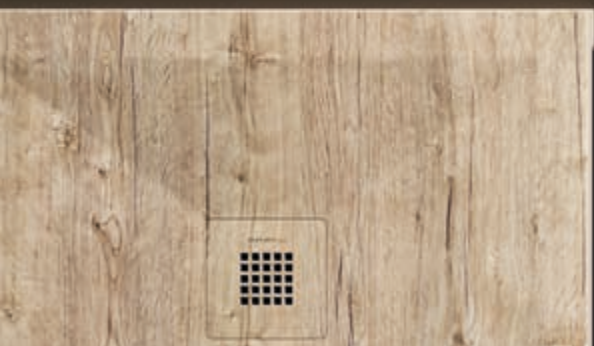

▼
VOTRE DOUCHE
TON TEMPS

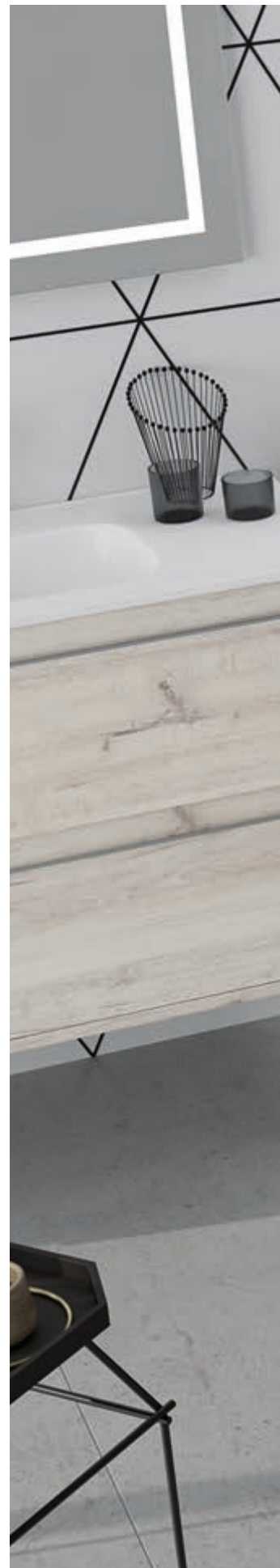



Decapé · Decapé · Décapé · Decapé · Decape



Nature · Nature · Nature · Nature · Natur





Baobab · Baobab · Baobab · Baobab · Baobab





LA TUA DOCCIA
IL TUO
MOMENTO





Márquina · Marquina · Marquina · Marquina · Marquina



Mármol Negro · Black Marble · Marbre Noir · Marmo Nero · Schwarzer Marmor



Mármol Crema · Cream Marble · Marbre Crème · Marmo Crema · Creme Marmor



Marmol Blanco · White Marble · Marbre Blanc · Marmo Bianco · Weißer Marmor

■
TU DUCHA,
TU MOMENTO





Granito Blanco · White Granite · Granite Blanc · Granite Bianco · Weißer Granit



Terrazo Beige · Beige Terrazzo · Terrazzo Beige · Terrazo Beige · Terrazzo Beige



Terrazo Gris · Gray Terrazzo · Terrazzo Grey · Terrazo Grigio · Terrazzo Grau



Terrazo Negro · Black Terrazzo · Terrazo Noir · Terrazo Nero · Terrazzo Schwarz

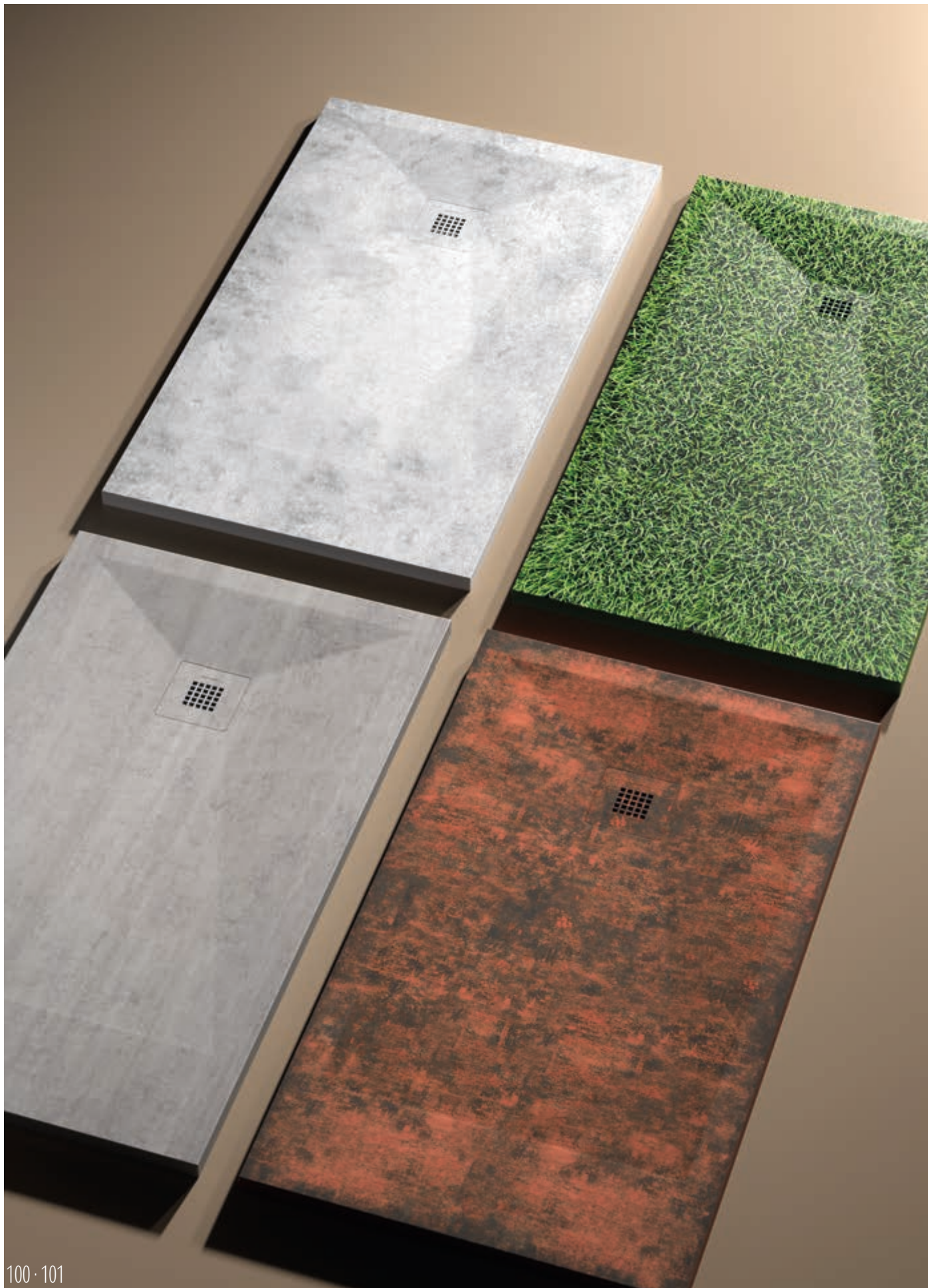



Césped · Grass · Gazon · Prado · Gras

▶
IHRE DUSCHE
DEINE ZEIT





Microcemento · Concrete · Béton · Calcestruzzo · Mikrozement



Óxido · Oxide · Rouille · Ossido · Oxid



I. Cement · I. Cement · I. Ciment · I. Cemento · Industriezement



Hidráulico Color · Colour Hydraulic · Couleur Hydraulic · Colore idraulico · Hydraulik Farbe







Mosaico 01 Color · 01 Colour Mosaic · 01 Couleur Mosaïque · 01 Colore Mosaico · Mosaik 01 Farbe





Mosaico 02 Color · 02 Colour Mosaic · 02 Couleur Mosaïque · 02 Colore Mosaico · Mosaik 02 Farbe



Mosaico 02 BN · 02 WB Mosaic · 02 BN Mosaïque · 02 BN Mosaico · Mosaik 02 BN



AT *DUPLACH* WE HELP YOU
CREATE YOUR ENVIRONMENT

CHEZ *DUPLACH* NOUS VOUS AIDONS
À CRÉER VOTRE ENVIRONNEMENT

IN *DUPLACH* TI AIUTIAMO A
CREARE IL TUO AMBIENTE

WIR BEI *DUPLACH* HELFEN IHNEN,
IHRE UMGEBUNG ZU SCHAFFEN

A close-up photograph of a person's hand holding several pieces of white, irregularly shaped stones. The stones have a rough, crystalline texture. The background is filled with a large quantity of similar stones, creating a dense field of white and light grey. The lighting is soft, highlighting the textures of both the hand and the stones.

EN *DUPLACH* TE AYUDAMOS
A CREAR TU AMBIENTE.



Cemento 01 · Cement 01 · Ciment 01 · Cemento 01 · Zement 01





Cemento 02 · Cement 02 · Ciment 02 · Cemento 02 · Zement 02





Cemento 03 · Cement 03 · Ciment 03 · Cemento 03 · Zement 03





Cemento 04 · Cement 04 · Ciment 04 · Cemento 04 · Zement 04



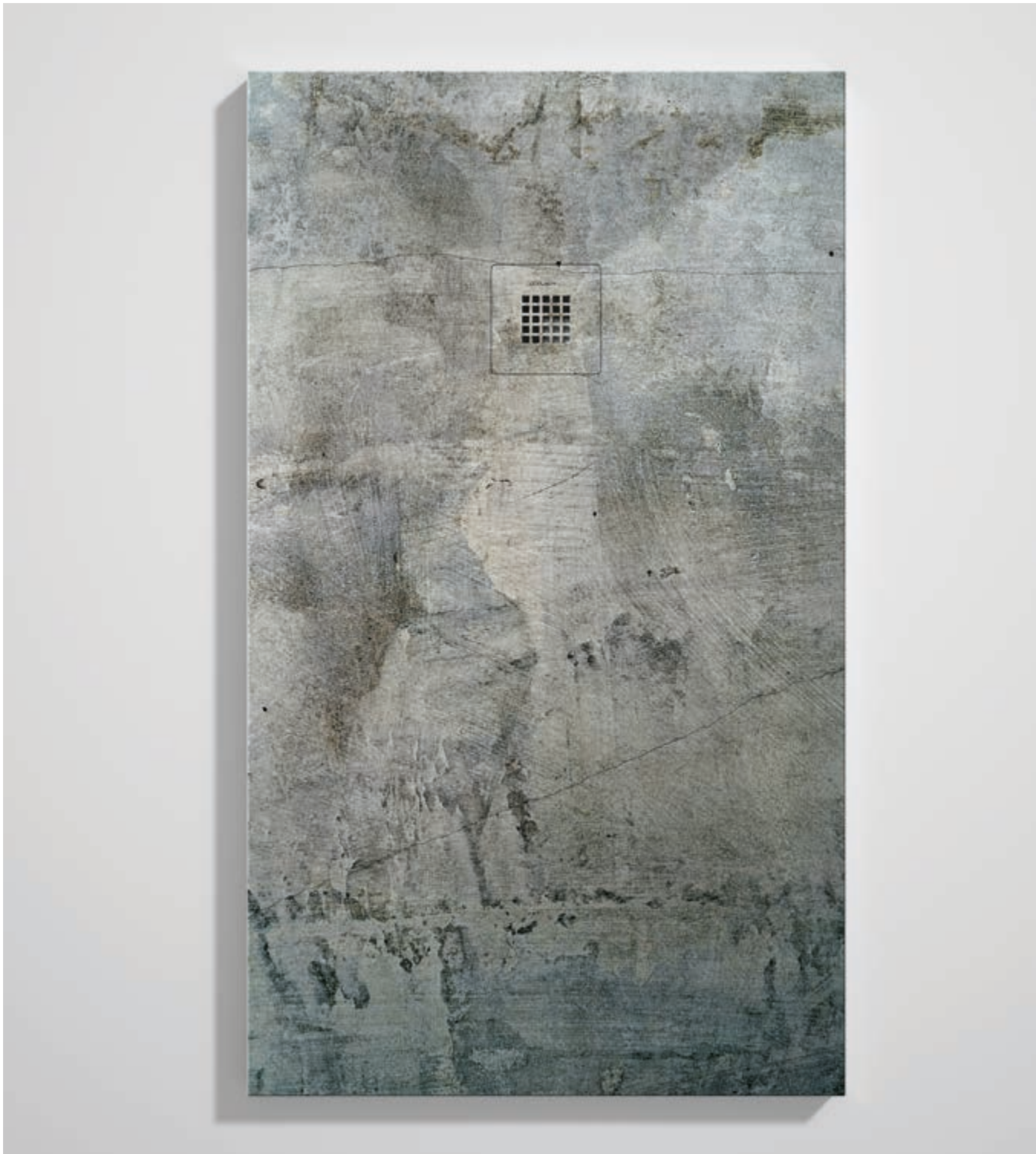

Cemento 05 · Cement 05 · Ciment 05 · Cemento 05 · Zement 05





Cemento 06 · Cement 06 · Ciment 06 · Cemento 06 · Zement 06





Cemento 07 · Cement 07 · Ciment 07 · Cemento 07 · Zement 07





Cemento 08 · Cement 08 · Ciment 08 · Cemento 08 · Zement 08





UNCARVED **MARBLE** CAN CONTAIN THE
BEST WORKS IN AN ARTIST'S THOUGHT.

LE **MARBRE** NON SCULPTÉ PEUT CONTENIR
LES MEILLEURES ŒUVRES DANS LA PENSÉE
D'UN ARTISTE.

IL **MARMO** NON LAVORATO PUÒ CONTE-
NERE LE MIGLIORI OPERE DEL PENSIERO
DI UN ARTISTA.

UNGESCHNITZTER **MARMOR** KANN DIE
BESTEN ARBEITEN IM GEDANKEN EINES
KÜNSTLERS ENTHALTEN.



EL **MÁRMOL** SIN TALLAR
PUEDE CONTENER LAS MEJORES OBRAS
EN EL PENSAMIENTO DE UN ARTISTA.

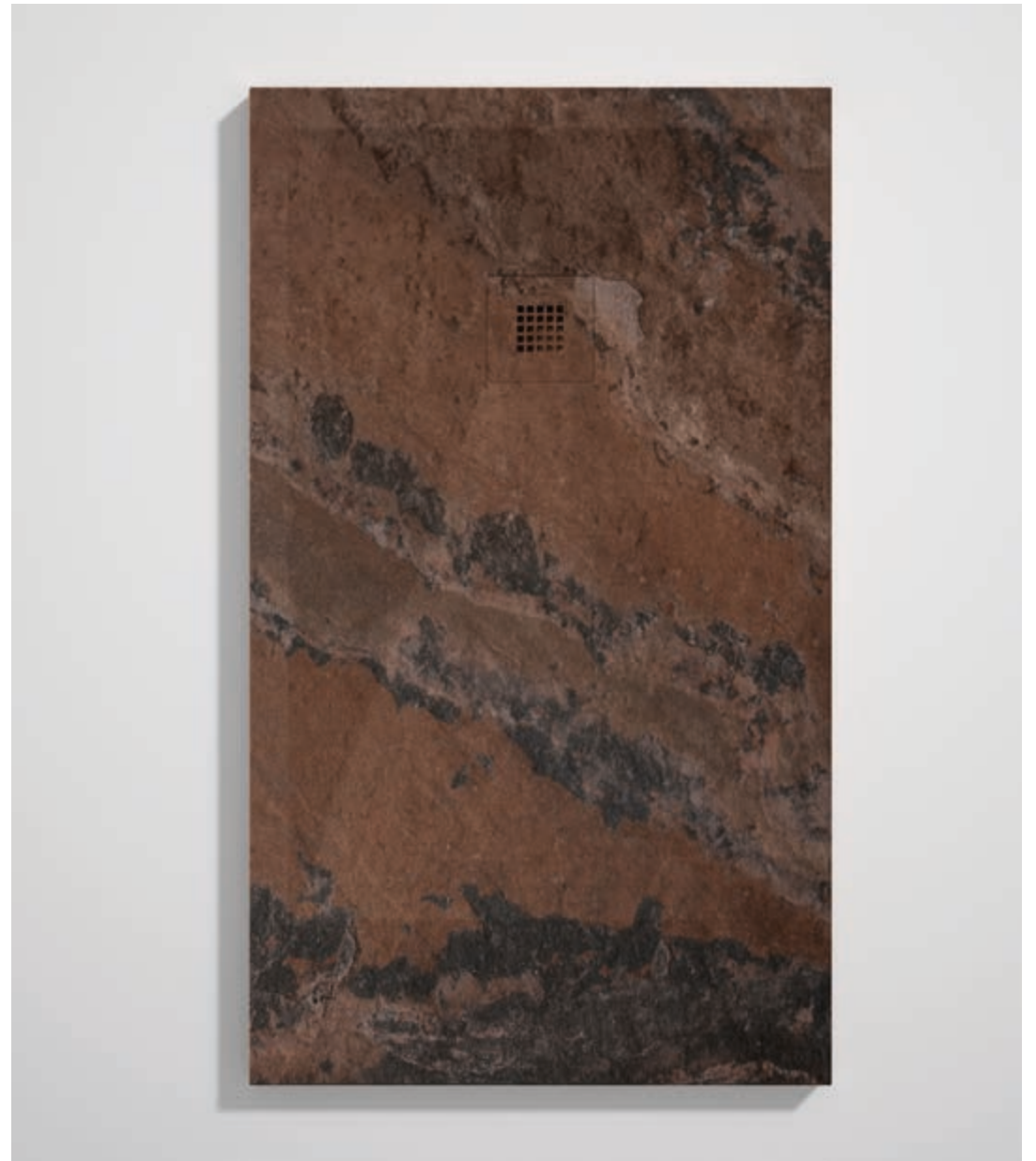

Mármol Óxido · Oxide Marble · Marbre d'oxyde · Ossido di marmo · Oxid marmor

■
TU DUCHA,
TU MOMENTO





Travertino Verde · Green Travertine · Travertin Vert · Travertino Verde · Grüner Travertin





Travertino Marrón · Brown Travertine · Travertin marron · Travertino Marrone · Brauner Travertin03





Oasis Marrón Claro · Light Brown Oasis · Oasis Marron Clair · Oasi Marrone Chiaro · Hellbraune Oase





Marrón Emperador · Emperor Brown · Empereur Brun · L'imperatore Bruno · Kaiser Braun





Emperador Claro · Light Emperor · Empereur léger · Imperatore della Luce · Kaiser des Lichts





Oasis Marrón Oscuro · Dark Brown Oasis · Oasis Marron Foncé · Oasi Marrone Scuro · Dunkelbraune Oase





Moscato Crema · Cream Muscat · Crème Muscat · Crema di Moscato · Creme Muscat



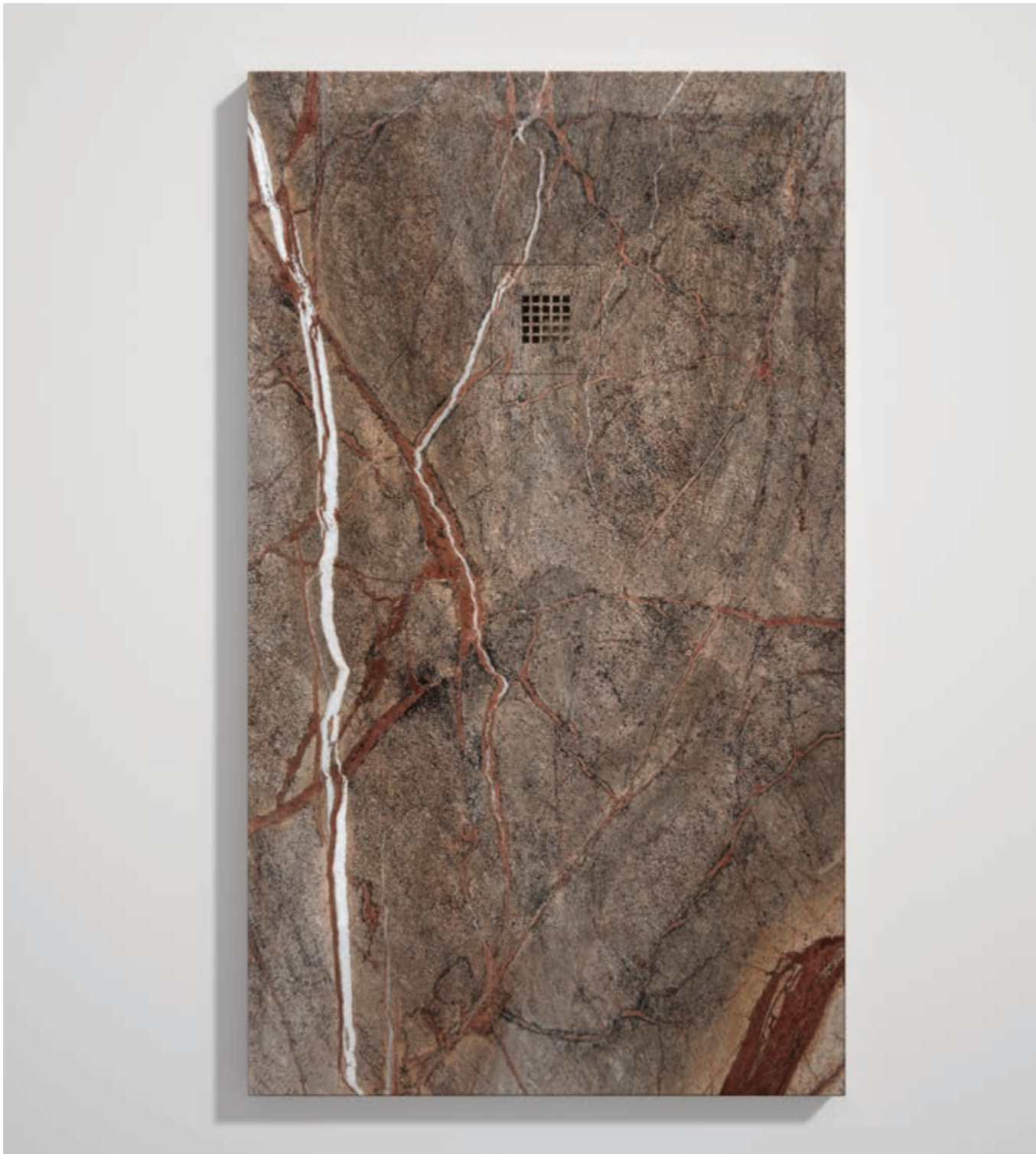

Rain Forest Brown · Rain Forest Brown · Rain Forest Brown · Rain Forest Brown · Rain Forest Brown





WOOD IS A UNIVERSALLY BEAUTIFUL NOBLE MATERIAL FOR THE PEOPLE.

LE BOIS EST UN MATÉRIAU NOBLE UNIVERSELLEMENT BEAU POUR LES PERSONNES.

IL LEGNO È UN MATERIALE NOBILE UNIVERSALMENTE BELLO PER LA GENTE.

HOLZ IST EIN UNIVERSELL SCHÖNES EDELSTOFF FÜR DIE LEUTE.

A vibrant scene featuring a row of colorful wooden houses with balconies, palm trees, and a white fence. The houses are painted in various colors like yellow, pink, green, and blue, with white trim and balconies. The scene is set against a bright blue sky with scattered white clouds. In the foreground, there are lush green bushes with red flowers and a white decorative fence. The overall atmosphere is bright and cheerful.

**LA MADERA ES UN MATERIAL NOBLE
UNIVERSALMENTE HERMOSO
PARA LAS PERSONAS.**



Rústico gris · Rustic gray · Gris rustique · Grigio rustico · Rustikal grau

▲
TU DUCHA,
TU MOMENTO





Rústico azul · Rustic blue · Bleu rustique · Blu rustico · Rustikal blau



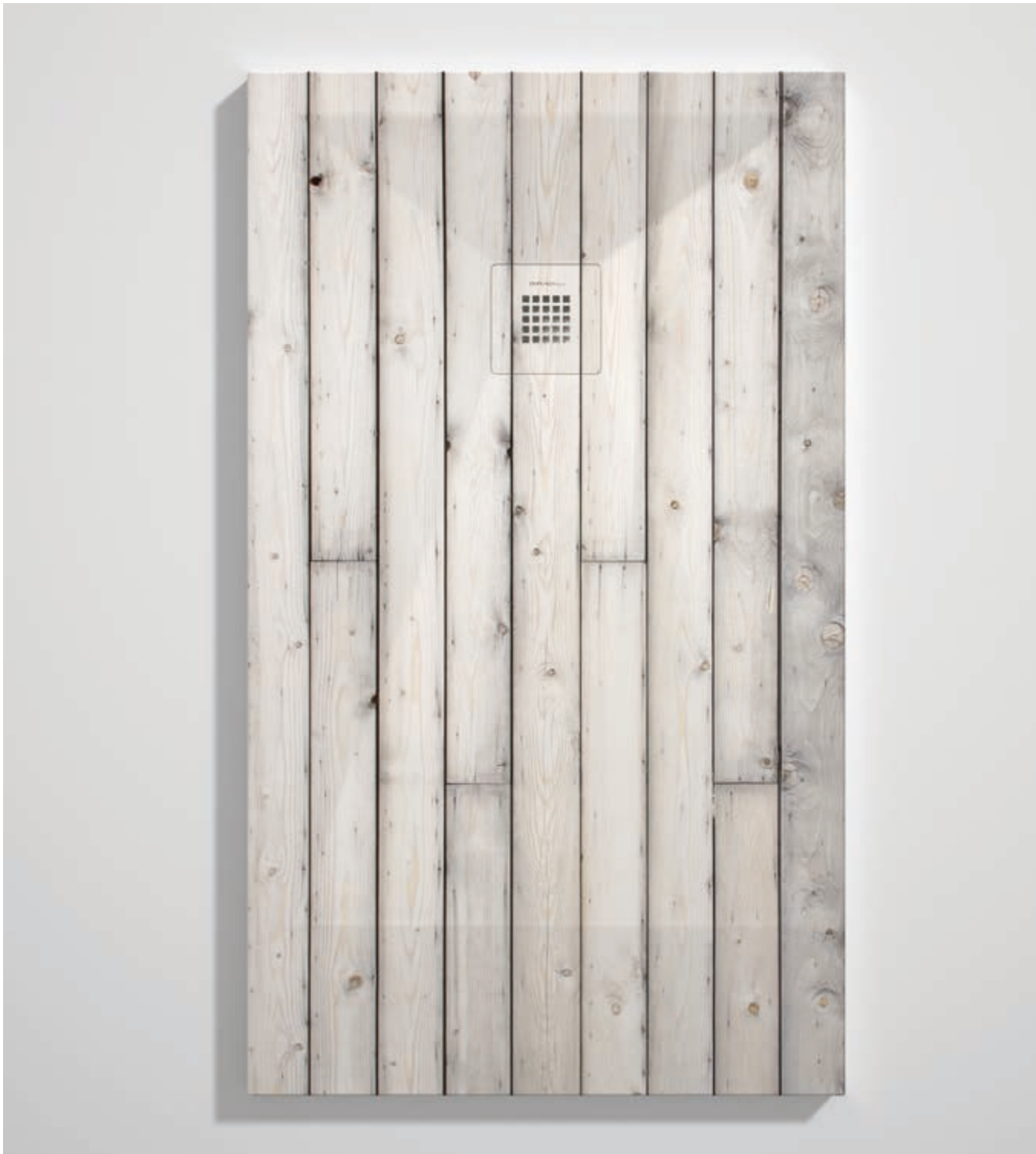

Rústico blanco · Rustic white · Blanc rustique · Bianco rustico · Rustikal weiß





Rústico · Rustic · Rustique · Rustico · Rustikal





Rústico Natural · Natural Rustic · Naturel Rustique · Rustico Naturale · Natürlich Rustikal





Vintage Blanco · Vintage White · Vintage Blanc · Bianco Vintage · Vintage Weiß





Roble Moka · Mocha Oak · Chêne Moka · Rovere moka · Eiche Mokka



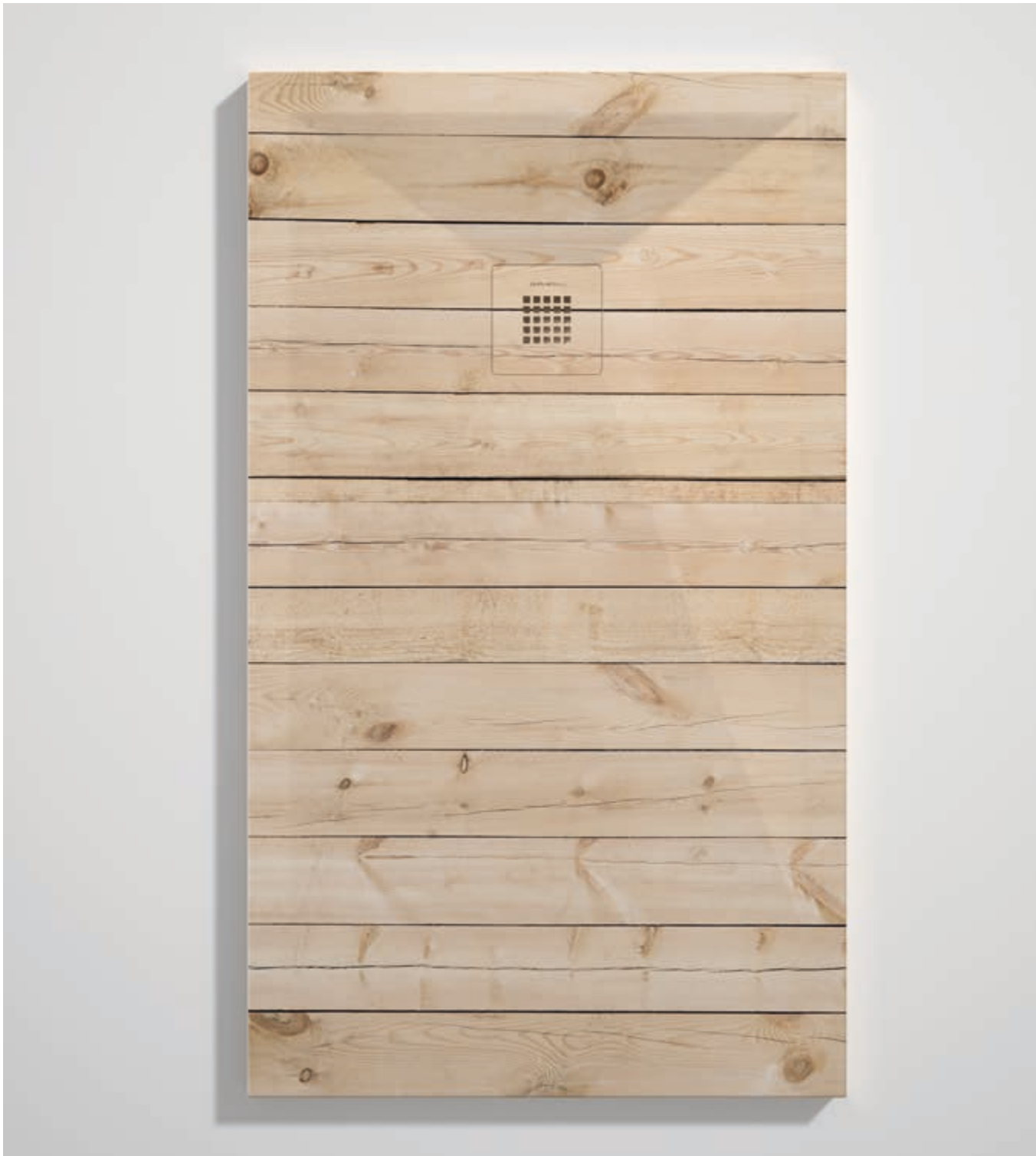

Pino Natural · Natural Pine · Pin Naturel · Pino Naturale · Natürliche Kiefer



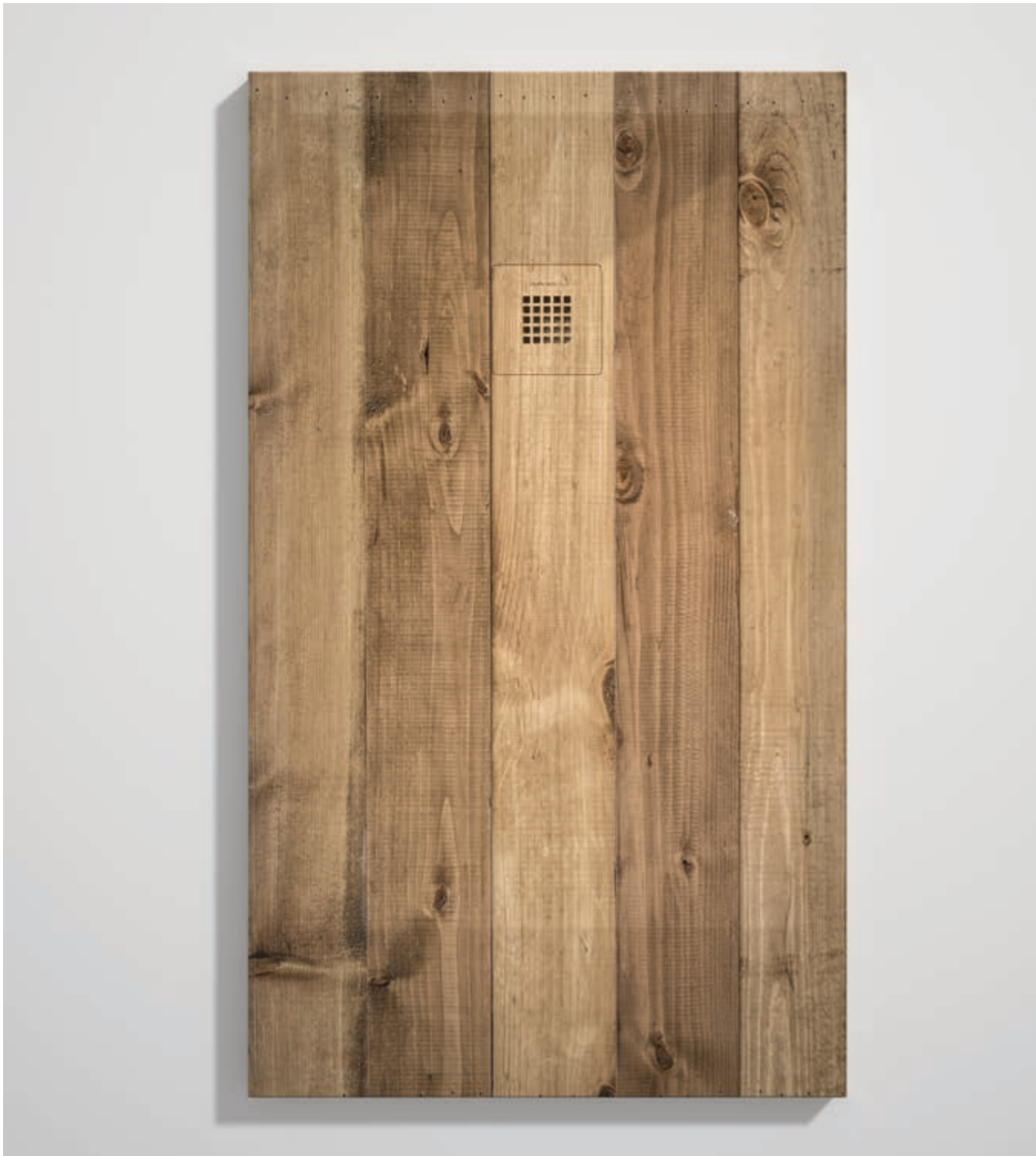

Roble Ahumado · Smoked Oak · Chêne Fumé · Rovere Affumicato · Geräucherte Eiche





Pino Flandes · Flanders Pine · Pin des Flandres · Pino delle Fiandre · Flandrische Kiefer





Pino Blanco · White Pine · Pin Blanc · Pino Bianco · Weiße Kiefer





Patina Blanco · White Patina · Patine blanche · Patina bianca · Weiße Patina





Madera Reciclada · Recycled Wood · Bois Recyclé · Legno Riciclato · Recycltes Holz



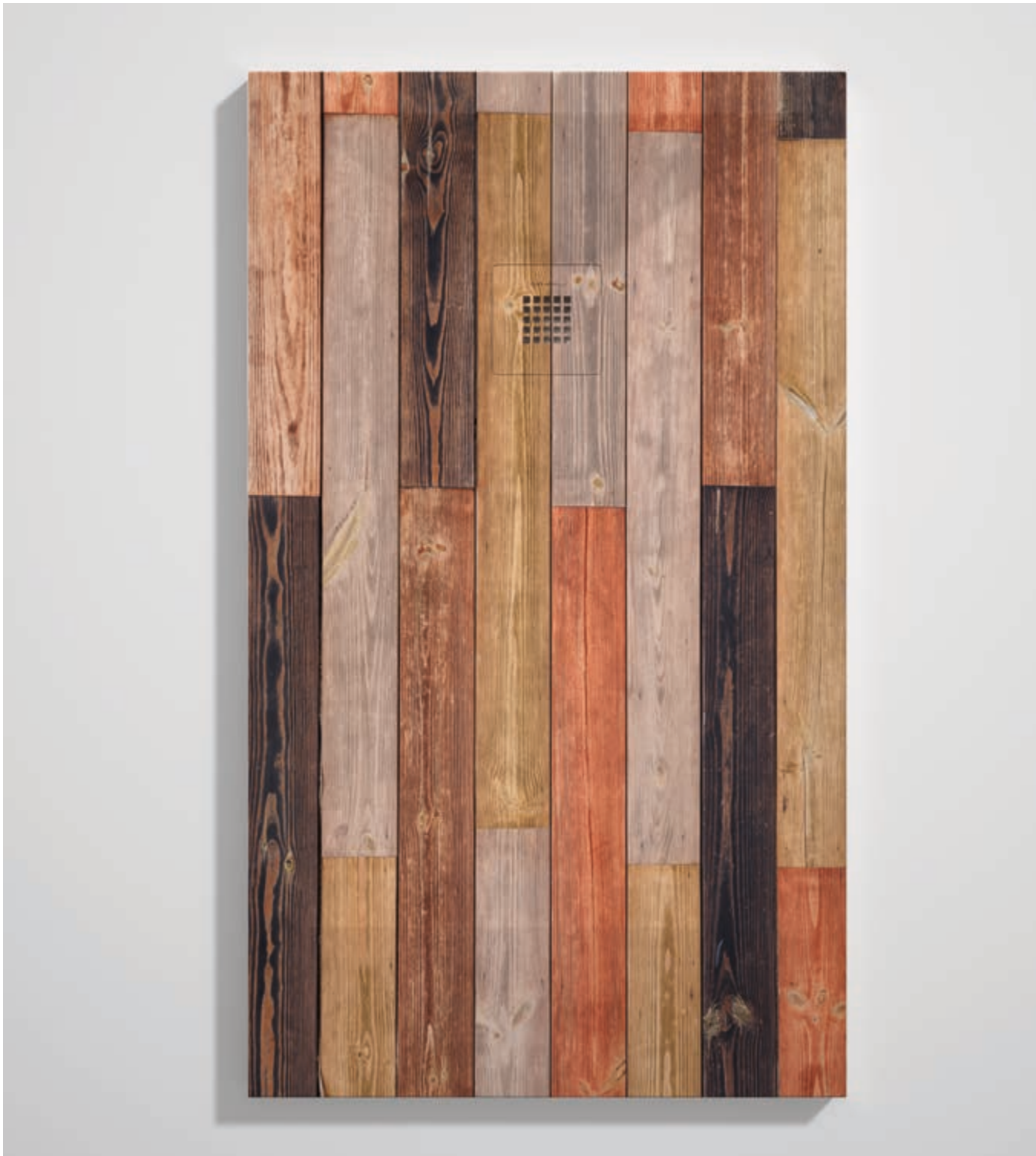

Cáucaso · Caucasus · Caucase · Caucaso · Kaukasus





Ébano · Ebony · Ébène · Ebano · Ebenholz



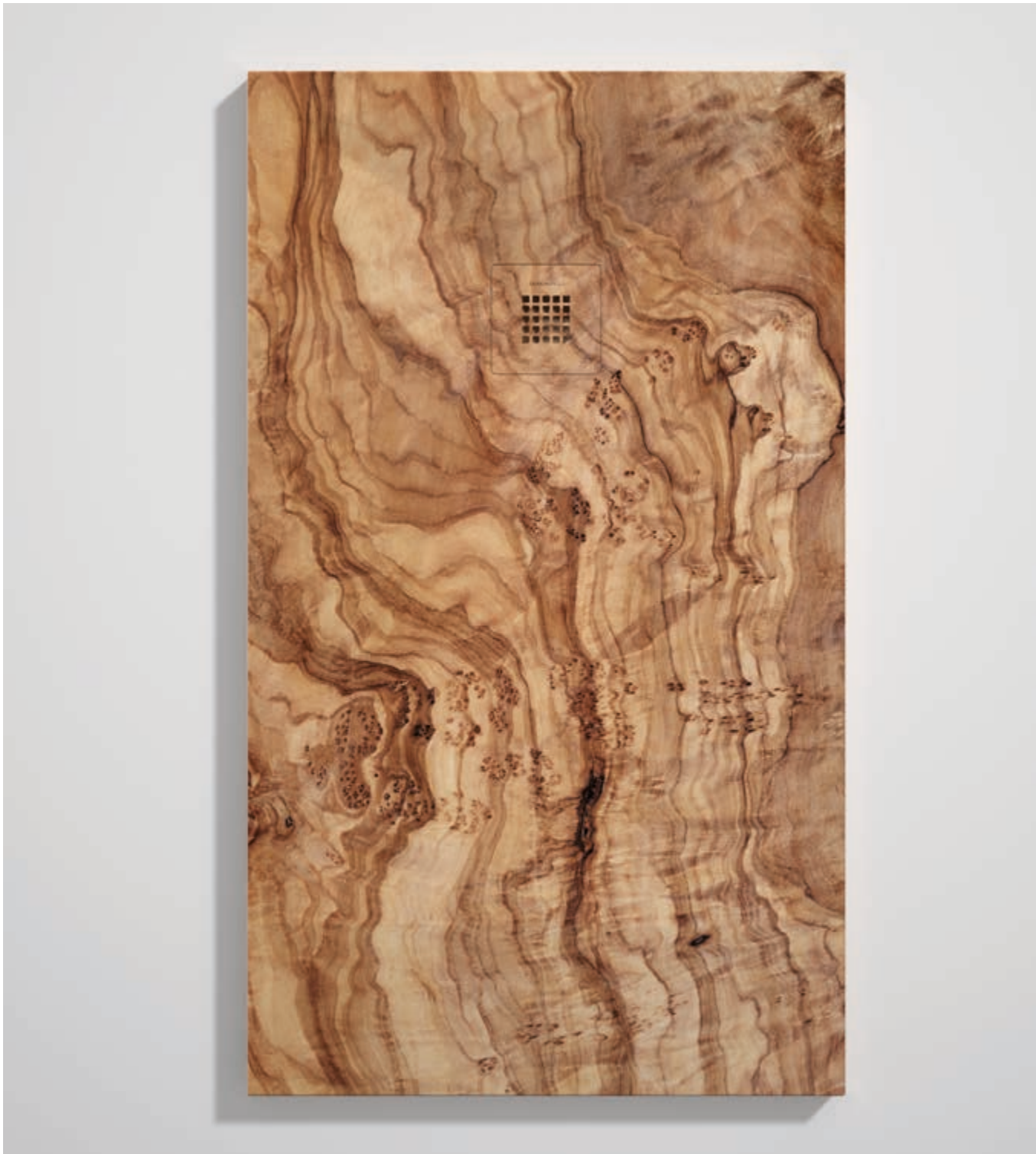

Olivo 01 · Olive 01 · Olive 01 · Oliva 01 · Olive 01





Olivo 02 · Olive 02 · Olive 02 · Oliva 02 · Olive 02



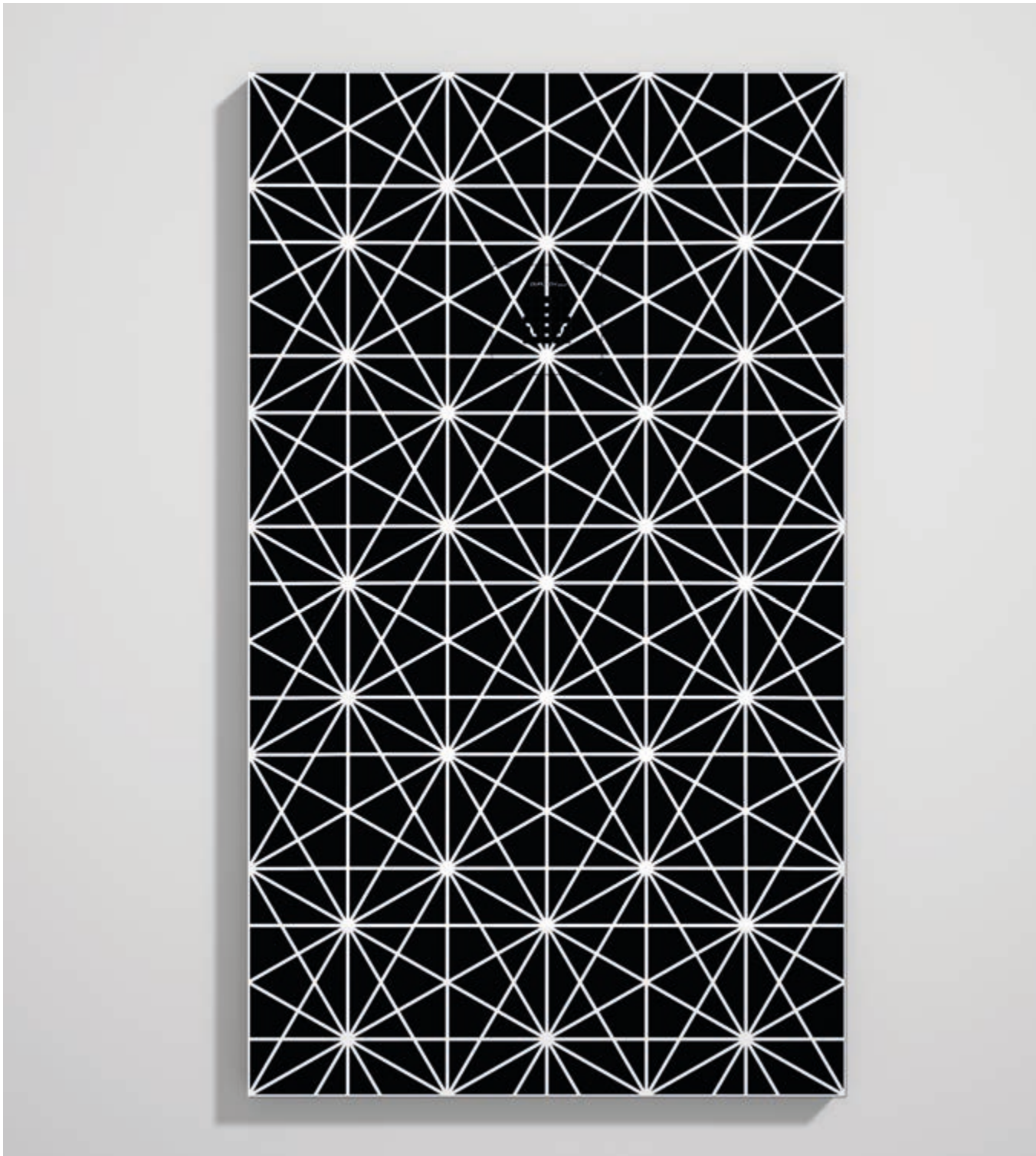

Geométricos 01 · Geometric 01 · Géométrique 01 · Geometrico 01 · Geometrisch 01



Geométricos 02 · Geometric 02 · Géométrique 02 · Geometrico 02 · Geometrisch 02



Geométricos 03 · Geometric 03 · Géométrique 03 · Geometrico 03 · Geometrisch 03



A vibrant, sunlit forest scene with tall, slender trees and a dense canopy of bright green leaves. Sunlight streams through the trees, creating a warm, golden glow and long shadows on the forest floor. The overall atmosphere is peaceful and natural.

LOOK AT **NATURE** AND THEN YOU WILL
UNDERSTAND EVERYTHING BETTER

REGARDEZ LA **NATURE** ET
ALORS VOUS COMPRENDREZ MIEUX TOUT

GUARDA LA **NATURA** E
ALLORA CAPIRAI TUTTO MEGLIO

BETRACHTEN SIE DIE **NATUR** UND
DANN VERSTEHST DU ALLES BESSER

A photograph of a dense forest with tall trees and a thick undergrowth of green plants. Sunlight filters through the canopy, creating a bright, airy atmosphere. The text is overlaid on the lower right portion of the image.

MIRA EN LA **NATURALEZA** Y
ENTONCES COMPRENDERÁS TODO MEJOR

ALBERT EINSTEIN



Hojas 01 · Leaves 01 · Feuilles 01 · Lascia 01 · Blätter 01

■
TU DUCHA,
TU MOMENTO





Hojas 02 · Leaves 02 · Feuilles 02 · Lascia 02 · Blätter 02





Hojas 03 · Leaves 03 · Feuilles 03 · Lascia 03 · Blätter 03





Flores · Flower · Fleurs · Fiori · Blumen



An underwater photograph showing a vibrant coral reef in the foreground and middle ground. The coral is primarily yellow and green, with some blue and white patches. Numerous small, dark blue fish are swimming throughout the scene, some near the coral and others in the open water. The background is a deep, clear blue, suggesting a healthy marine environment.

IN A DROP OF **WATER** THE SECRETS OF
ALL THE SEAS ARE FOUND

DANS UNE GOUTTE D'**EAU** SE TROUVENT LES
SECRETS DE TOUTES LES MERS

IN UNA GOCCIA D'**ACQUA** SI TROVANO I
SEGRETI DI TUTTI I MARI

IN EINEM TROPFEN **WASSER** LIEGEN DIE GE-
HEIMNISSE ALLER MEERE

An underwater photograph of a vibrant coral reef. The foreground is dominated by large, rounded, light-green coral structures. Numerous small, colorful fish, including blue and yellow ones, are swimming around the coral. The background shows a deep blue ocean with more coral formations and a school of small fish. The overall scene is bright and clear, suggesting a healthy marine ecosystem.

EN UNA GOTTA DE **AGUA** SE ENCUENTRAN
LOS SECRETOS DE TODOS LOS MARES



Piscina · Pool water · Piscine · Piscina · Schwimmbad





Ola · Wave · Onde · Onde de mer · Meereswelle





Gotas · Drops · Gouttes · Gocce · Tropfen





Mar · Sea · Mer · Mare · Meer



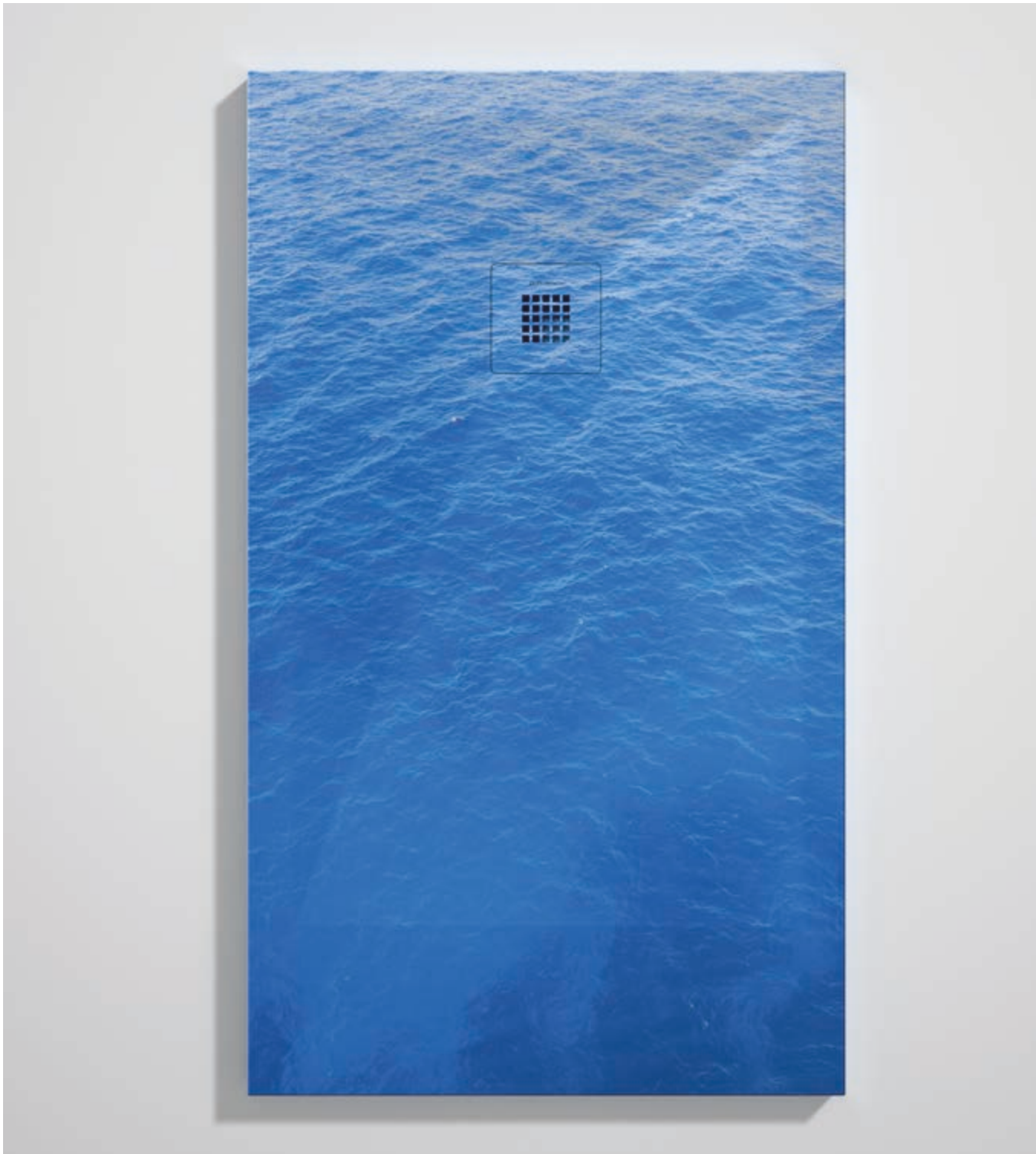

Calma · Calm down · Calmer · Calmati · Sich beruhigen





EVERY MORNING WE ARE BORN AGAIN,
WHAT WE DO TODAY IS WHAT MATTERS.

CHAQUE MATIN NOUS NOUS RENAISSONS,
CE QUE NOUS FAISONS AUJOURD'HUI EST CE QUI COMPTE.

OGNI MATTINA SIAMO NATI DI NUOVO,
QUELLO CHE FACCIAMO OGGI È QUELLO CHE CONTA.

JEDEN MORGEN WERDEN WIR WIEDER GEBOREN,
WAS WIR HEUTE TUN, IST, WAS WIR TUN.

A silhouette of a person sitting in a meditative pose (Padmasana) on a grassy hill. The person is facing away from the viewer, looking towards a vast landscape of rolling hills and mountains under a bright, hazy sky. The sun is low on the horizon, creating a warm, golden glow and long, soft shadows. The overall mood is peaceful and contemplative.

CADA MAÑANA NACEMOS DE NUEVO,
LO QUE HACEMOS HOY ES LO QUE IMPORTA.

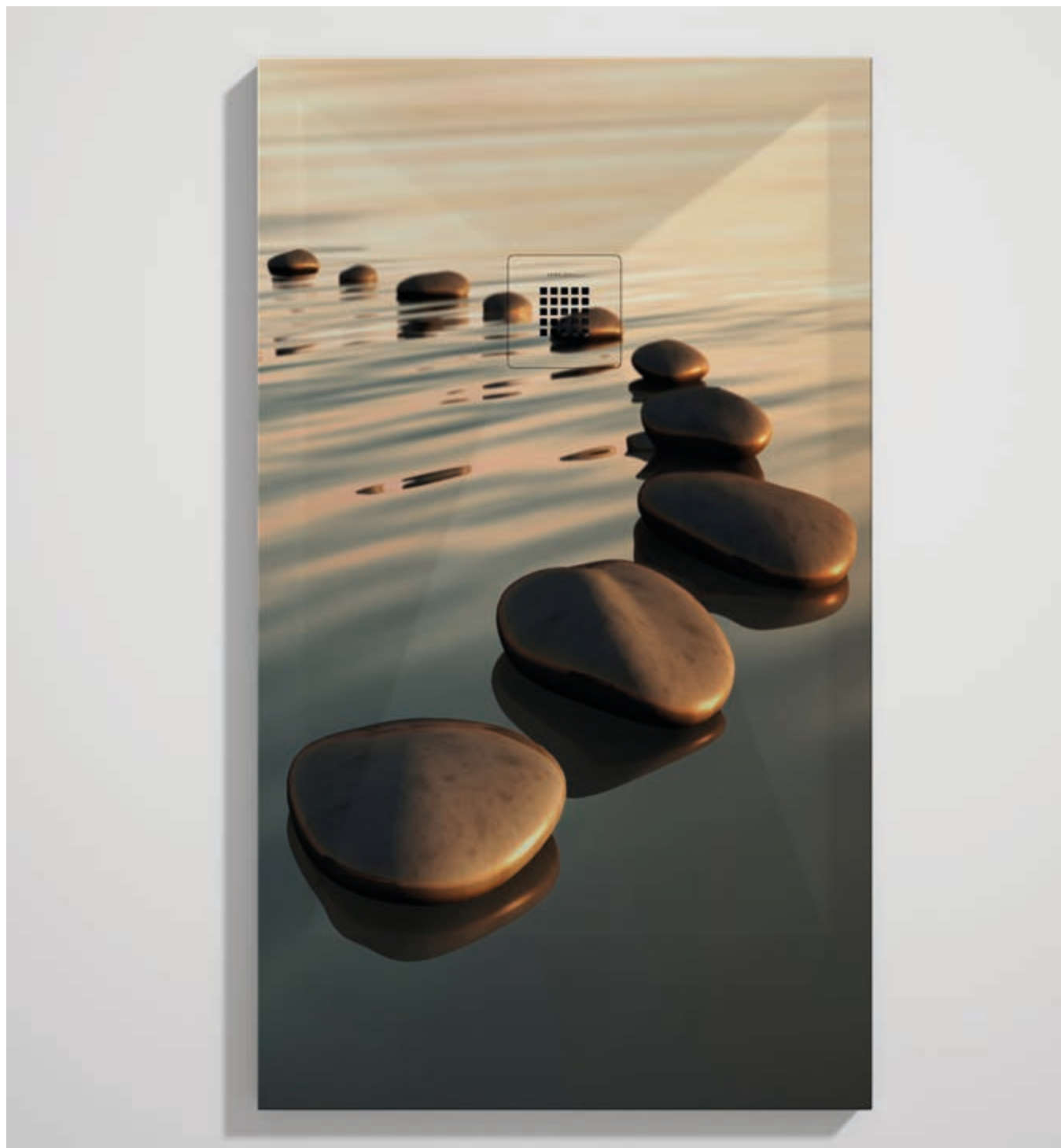

Zen 01 · Zen 01 · Zen 01 · Zen 01 · Zen 01



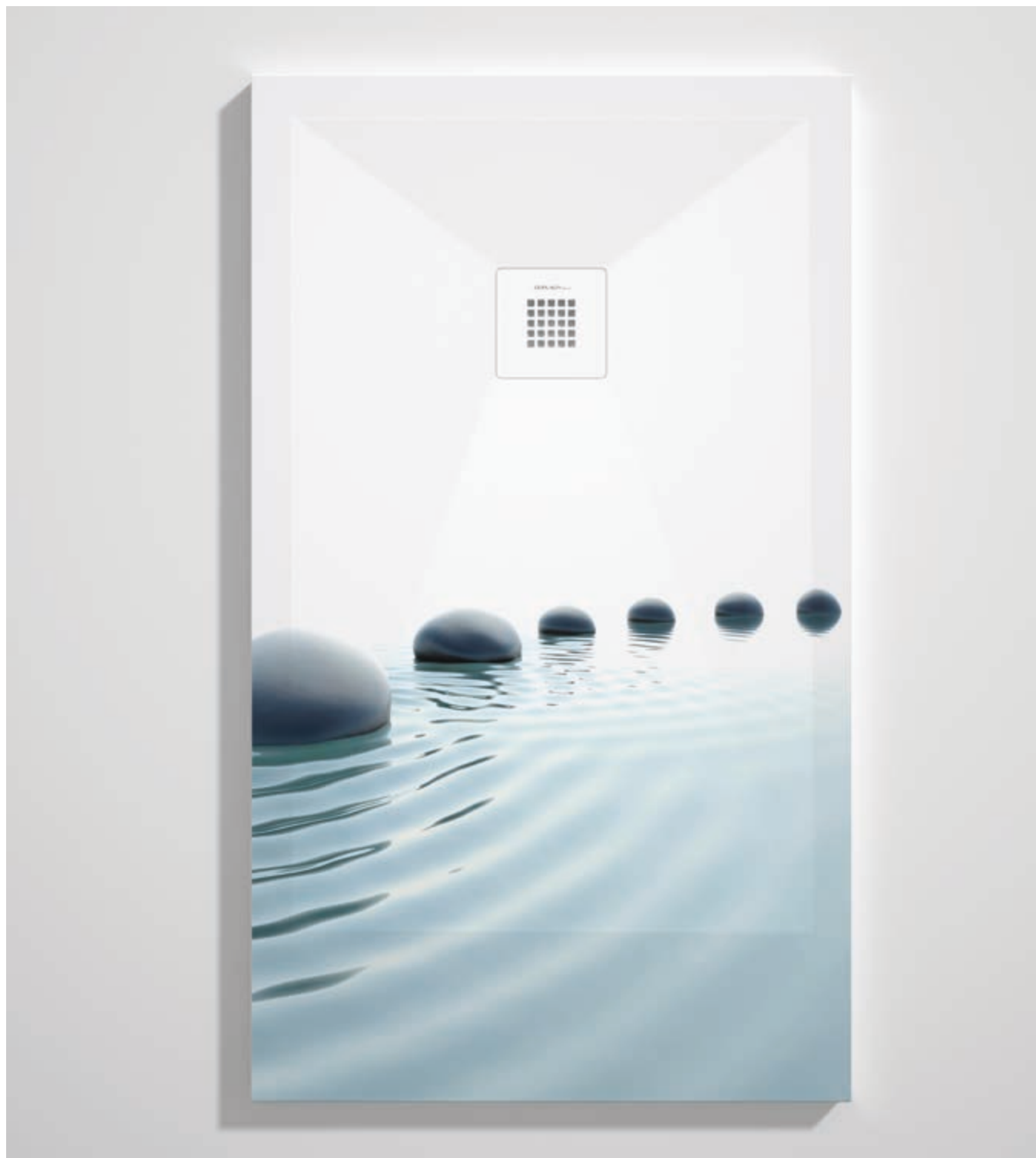

Zen 02 · Zen 02 · Zen 02 Zen 02 · Zen 02



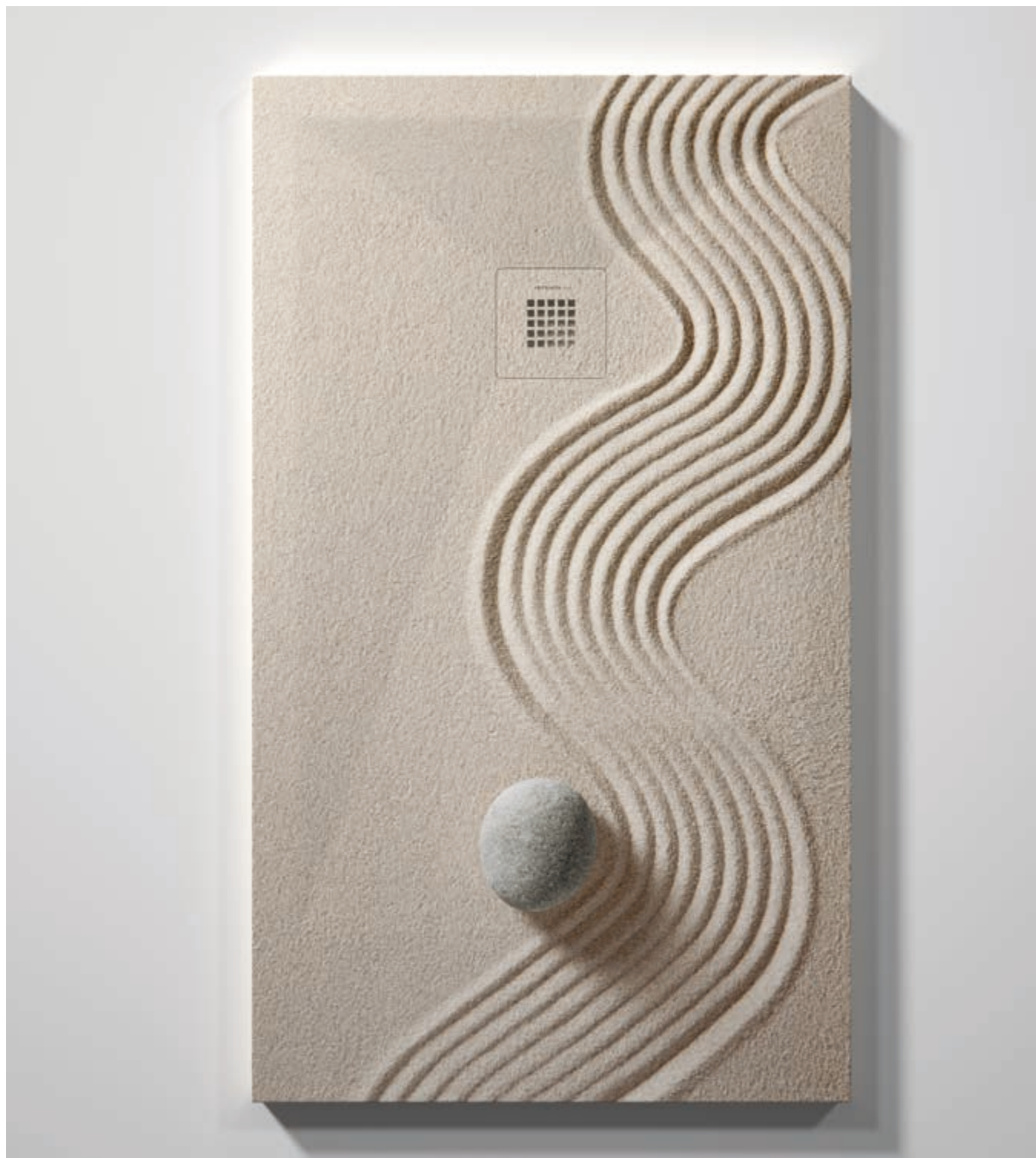

Zen 03 · Zen 03 · Zen 03 · Zen 03 · Zen 03





Zen 04 · Zen 04 · Zen 04 · Zen 04 · Zen 04



THAT GROWING UP DOES NOT
MEAN STOP BEING **CHILDREN**

QUE GRANDIR NE SIGNIFIE PAS
CESSER D'ÊTRE DES **ENFANTS**

CHE CRESCERE NON SIGNIFICA
SMETTERE DI ESSERE **BAMBINI**

DASS ERWACHSEN NICHT BEDEUTET,
KINDER ZU SEIN





QUE CRECER NO SIGNIFIQUE
DEJAR DE SER **NIÑOS.**

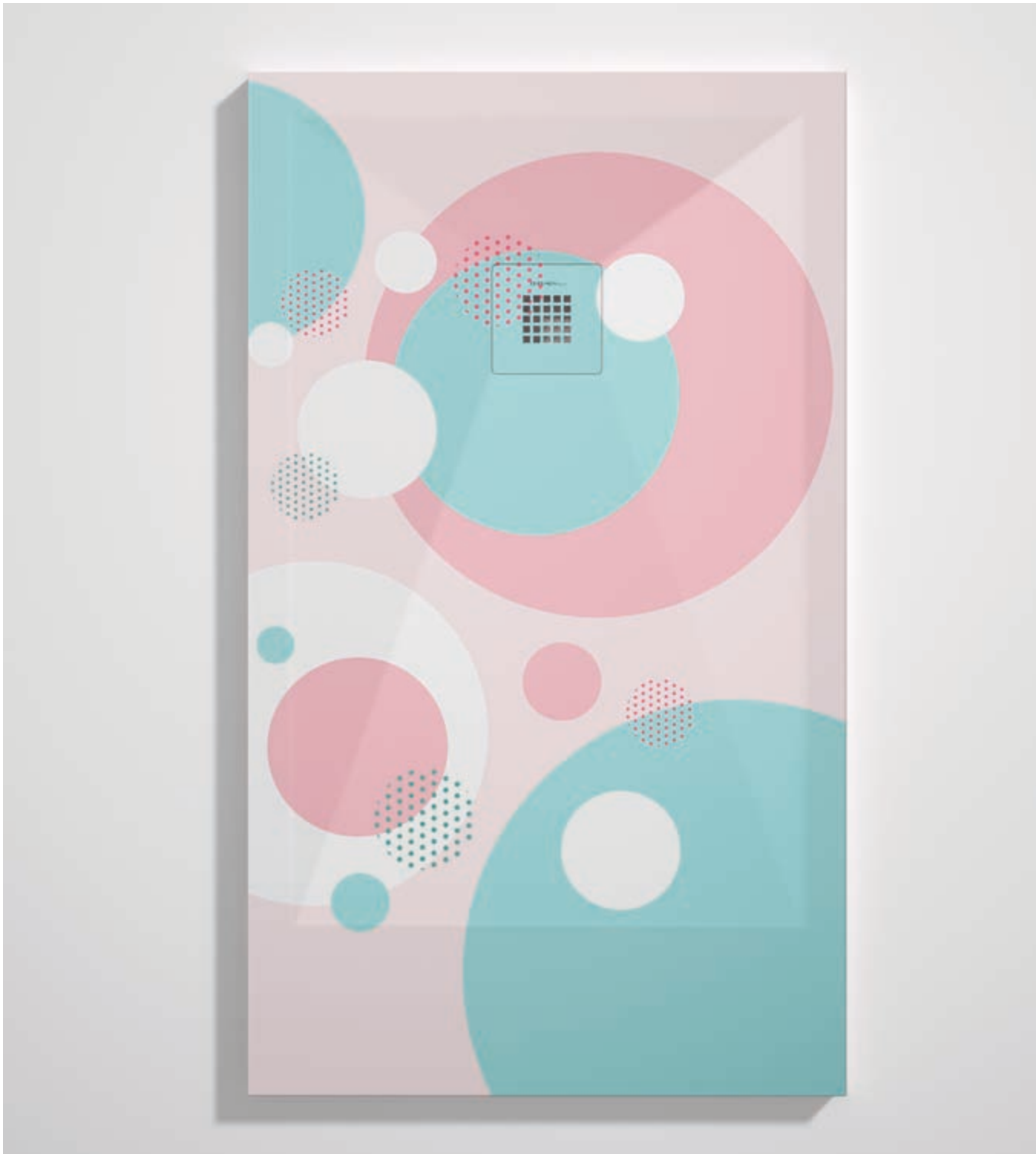

Círculos · Circle · Cercles · Cerchi · Kreise





Nordic · Nordic · Nordic · Nordic · Nordic





Puntos · Dots · Points · Puntii · Punkte





Acuarela · Watercolor · Aquarelle · Acquarello · Aquarell



ENOTS 3D

Nula absorción del agua.
Alta resistencia al rayado.
Dureza en la escala de Barcol de 45.
Resistente al cambio de temperatura.
Antideslizante.
Antibacterias.
Agentes químicos.
100% personalizable por el cliente.
Su grosor es de 3 cm.

Zero water absorption.
High scratch resistance.
Rated 45 on the Barcol hardness scale.
Resistant to temperature change.
Anti-slip.
Antibacterial
Resistant to chemical agents.
Fully customizable.
Its thickness is 3 cm width.

Pas d'absorption d'eau.
Haute résistance aux rayures.
Haute résistance aux rayures.
Dureté sur l'échelle Barcol de 45.
Résistant au changement de température.
Antidérapant
Antibactérien
Agents chimiques.
100% personnalisable par le client.
Son épaisseur est de 3 cm.

Assorbimento nullo dell'acqua
Elevata resistenza al graffio
Scala di durezza di 45 barcol
Resistente alle variazioni di temperatura
Antiscivolo
Antibatterico
Resistente ai prodotti chimici
100% personalizzabile dal cliente
Il suo spessore è di 3 cm. Circa.

Keine Wasseraufnahme.
Hohe Kratzfestigkeit.
Härte auf der Barcolskala 45.
Beständig gegen Temperaturänderung.
Rutschfest.
Antibakteriell.
Beständig gegen chemische Mittel.
100% anpassbar durch den Kunden.
Seine Dicke beträgt 3 cm

DISEÑO · DESIGN · CONCEPTION · DISEGNO · DESIGN

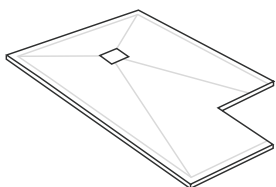

Adaptamos el diseño del plato a cualquier forma.
Incluido en precio.

Trays adaptable to non-standard shapes. Included in price.

Nous adaptons le design du plat à toutes les formes.
Inclus dans le prix.

Sagoniamo e adattiamo il piatto a qualsiasi richiesta.
Compreso nel prezzo.

Wir passen das Design der Duschwanne an jede Form an. Im Preis inbegriffen.

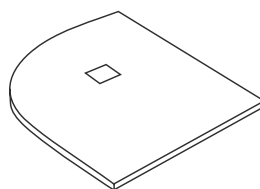

Medidas 80 y 90 incluidos con radio 50 cm.
Otras medidas y radios incremento de 50€ PVP.

Measures 80 and 90 along with radius 50 cm.
Other measures and radios mean a € 50 sales price increase/each

Mesure 80 et 90 inclus avec un rayon de 50 cm.
Les autres mesures et rayon augmentent de 50 € Prix Public

Misure 80 e 90 comprese con raggio di 50 cm.
Altre misure e raggio aumento di € 50 PVP.

Radiuskurve von 50 cm bei den Maßen 80 cm und 90 cm ohne Aufpreis.
Andere Maße und Radius mit Aufpreis von 50 € Verkaufspreis

TEXTURAS · TEXTURES TEXTURES · STRUTTURE · TEXTUR

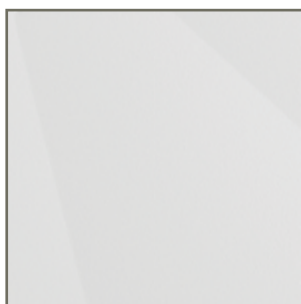

Liso
Smooth
Lisse
Liscio
Glatt

REJILLA · GRID GRILLE · GRIGLIA · GITTER



Rejilla Impresa 1 Cara Incluida en precio
1 Sided Printed Grid Included in price
Grille imprimée face incluse dans le prix
Griglia Stampata su un Solo Lato compreso nel prezzo
Einseitig bedrucktes Gitter im Preis inbegriffen.

VÁLVULA · WASTE BONDE · VALVOLA · VENTIL



Válvula 90. Incluida en precio
Waste 90. Included in price
Bonde 90. Inclus dans le prix
Valvola 90. Compreso nel prezzo
Ventil 90. Im preis inbegriffen

DISEÑOS ESTÁNDAR · STANDARD DESIGN · DESIGNS STANDAR · DESIGNS STANDAR

Se realiza sobre una base de masa coloreada en los tonos de nuestra carta de color que más se adecúe al diseño, a la que se aplica en la cara superior con un sistema de digitalización propio, un diseño que ofrece infinitas posibilidades de personalización y de durabilidad garantizada gracias a su recubrimiento con GEL COAT.

Los productos realizados con diseños diferentes a los estándar aquí mostrados están exentos de devolución.

Il est fait sur une base de masse colorée dans les nuances de notre nuancier qui convient le mieux au design, auquel il est appliqué sur la face supérieure avec son propre système de numérisation, un design qui offre des possibilités infinies de personnalisation et de durabilité. Garanti grâce à son revêtement avec GEL COAT.

Les produits fabriqués avec des conceptions autres que les normes indiquées ici sont exemptés de retour.

It is done on a colored mass base in the shades of our color chart that best suits the design, to which it is applied on the upper face with its own digitalization system, a design that offers infinite possibilities for customization and durability. Guaranteed thanks to its coating with GEL COAT.

Products made with designs other than the standards shown here are exempt from return.

È realizzato su una base di massa colorata nelle tonalità della nostra cartella colori che meglio si adatta al disegno. Sul lato superiore viene applicato, con il proprio sistema di digitalizzazione, un disegno che offre infinite possibilità di personalizzazione e garanzia di durata grazie al rivestimento con GEL COAT.

Il prodotti realizzati con disegni diversi da quelli standard qui illustrati sono esenti da restituzione.

Diese werden auf der Basis einer farbigen Masse in den Farbtönen unserer Farbkarte hergestellt, die am besten zum Design passt, auf das es mit einem eigenen Digitalisierungssystem auf der Oberseite aufgetragen wird. Diese Designs bieten unendlich viele Möglichkeiten zur Anpassung und Haltbarkeit, garantiert dank seiner Gel Coat Beschichtung.

Produkte, die mit anderen als den hier gezeigten Standarddesigns hergestellt wurden, sind von der Rücksendung ausgenommen.



Nogal
Walnut
Noyer
Noce
Walnuss



Roble
Oak
Chêne
Quercia
Eiche



Ceniza
Ash
Cendre
Cenere
Asche



Vintage
Vintage
Vintage
Vintage
Vintage



Nature
Nature
Nature
Nature
Natur



Decapé
Decapé
Décape
Decapé
Decape



Baobab
Baobab
Baobab
Baobab
Baobab

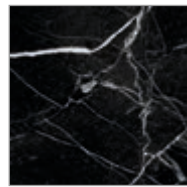

Mármol Negro
Black Marble
Marbre Noir
Marmo Nero
Schwarzer Marmor

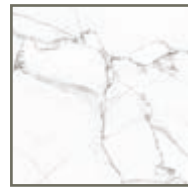

Marmol Blanco
White Marble
Marbre Blanc
Marmo Bianco
Weißer Marmor



Mármol Crema
Cream Marble
Marbre Crème
Marmo Crema
Creme Marmor

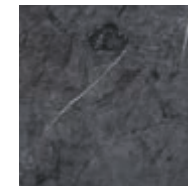

Márquina
Marquina
Marquina
Marquina
Marquina



Granito Blanco
White Granite
Granite Blanc
Granite Bianco
Weißer Granit

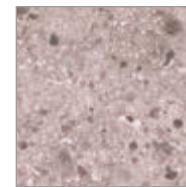

Terrazo Beige
Beige Terrazzo
Terrazzo Beige
Terrazzo Beige
Terrazzo Beige



I. Cement
I. Cement
I. Ciment
I. Cemento
Industriezement



Microcemento
Concrete
Béton
Calcestruzzo
Mikrozement

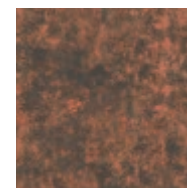

Óxido
Oxide
Rouille
Ossido
Oxid

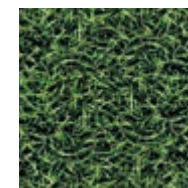

Césped
Grass
Gazon
Prado
Gras



Terrazo Gris
Gray Terrazzo
Terrazzo Grey
Terrazzo Grigio
Terrazzo Grau

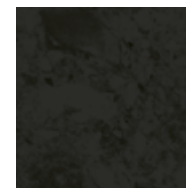

Terrazo Negro
Black Terrazzo
Terrazzo Noir
Terrazzo Nero
Terrazzo Schwarz



Mosaico 01 BN
01 WB Mosaic
01 BN Mosaïque
01 BN Mosaico
Mosaik 01 BN



Mosaico 01 Color
01 Colour Mosaic
01 Couleur Mosaïque
01 Colore Mosaico
Mosaik 01 Farbe



Mosaico 02 BN
02 WB Mosaic
02 BN Mosaïque
02 BN Mosaico
Mosaik 02 BN



Mosaico 02 Color
02 Colour Mosaic
02 Couleur Mosaïque
02 Colore Mosaico
Mosaik 02 Farbe



Hidráulico BN
BW Hydraulic
BN Hydraulic
BN idraulico
Hydraulik BN

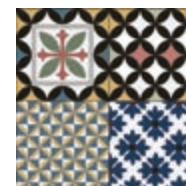

Hidráulico Color
Colour Hydraulic
Couleur Hydraulic
Colore idraulico
Hydraulik Farbe

NUEVOS DISEÑOS · NEW DESIGNS · NOUVELLES CONCEPTIONS · NUOVI DISEGNI · NEUE DESIGNS



Cemento 01
Cement 01
Ciment 01
Cemento 01
Zement 01



Cemento 02
Cement 02
Ciment 02
Cemento 02
Zement 02



Cemento 03
Cement 03
Ciment 03
Cemento 03
Zement 03



Cemento 04
Cement 04
Ciment 04
Cemento 04
Zement 04



Cemento 05
Cement 05
Ciment 05
Cemento 05
Zement 05

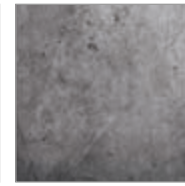

Cemento 06
Cement 06
Ciment 06
Cemento 06
Zement 06

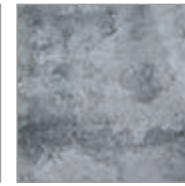

Cemento 07
Cement 07
Ciment 07
Cemento 07
Zement 07

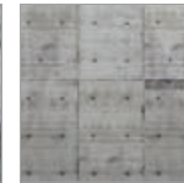

Cemento 08
Cement 08
Ciment 08
Cemento 08
Zement 08



Mármol Óxido
Oxide Marble
Marbre d'oxyde
Ossido di marmo
Oxid marmor



Travertino Verde
Green Travertine
Travertin Vert
Travertino Verde
Grüner Travertin



Travertino Marrón
Brown Travertine
Travertin marron
Travertino Marrone
Brauner Travertin

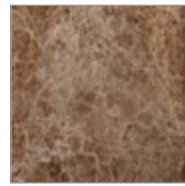

Oasis Marrón Claro
Light Brown Oasis
Oasis Marron Clair
Oasi Marrone Chiaro
Hellbraune Oase

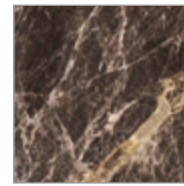

Marrón Emperador
Emperor Brown
Empereur Brun
L'Imperatore Bruno
Kaiser Braun



Emperador Claro
Light Emperor
Empereur léger
Imperatore della Luce
Kaiser des Lichts

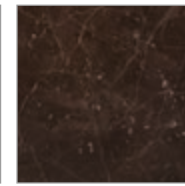

Oasis Marrón Oscuro
Dark Brown Oasis
Oasis Marron Foncé
Oasi Marrone Scuro
Dunkelbraune Oase



Moscato Crema
Cream Muscat
Crème Muscat
Crema di Moscato
Creme Muscat

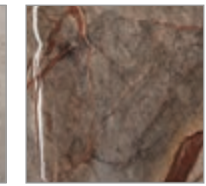

Rain Forest Brown
Rain Forest Brown
Rain Forest Brown
Rain Forest Brown
Rain Forest Brown



Rústico gris
Rustic gray
Gris rustique
Grigio rustico
Rustikal grau



Rústico azul
Rustic blue
Bleu rustique
Blu rustico
Rustikal blau

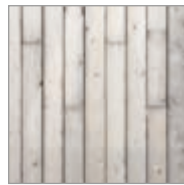

Rústico blanco
Rustic white
Blanc rustique
Bianco rustico
Rustikal weiß



Rústico
Rustic
Rustique
Rustico
Rustikal

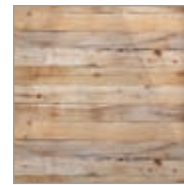

Rústico Natural
Natural Rustic
Naturel Rustique
Rustico Naturale
Natürlich rustikal

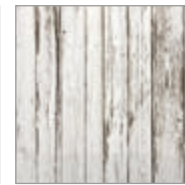

Vintage Blanco
Vintage White
Vintage Blanc
Bianco Vintage
Vintage Weiß



Roble Moka
Mocha Oak
Chêne Moka
Rovere moka
Eiche Mokka



Pino Natural
Natural Pine
Pin Naturel
Pino Natural
Natürliche Kiefer



Roble Ahumado
Smoked Oak
Chêne Fumé
Rovere Affumicato
Geräucherte Eiche



Pino Flandes
Flanders Pine
Pin des Flandres
Pino delle Fiandre
Flandrische Kiefer



Pino Blanco
White Pine
Pin Blanc
Pino Bianco
Weiße Kiefer



Patina Blanco
White Patina
Patine blanche
Patina bianca
Weiße Patina

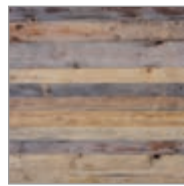

Madera Reciclada
Recycled Wood
Bois Recyclé
Legno Riciclato
Recyceltes Holz



Cáucaso
Caucasus
Caucase
Caucaso
Kaukasus



Ébano
Ebony
Ébène
Ebano
Ebenholz

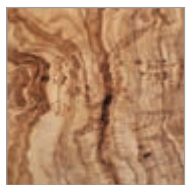

Olivo 01
Olive 01
Olive 01
Oliva 01
Olive 01



Olivo 02
Olive 02
Olive 02
Oliva 02
Olive 02

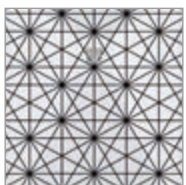

Geométricos 01
Geometric 01
Géométrique 01
Geometrico 01
Geometrisch 01

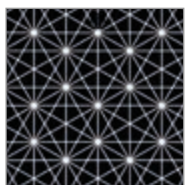

Geométricos 02
Geometric 02
Géométrique 02
Geometrico 02
Geometrisch 02

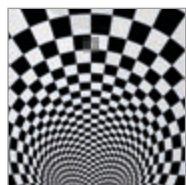

Geométricos 03
Geometric 03
Géométrique 03
Geometrico 03
Geometrisch 03



Hojas 01
Leaves 01
Feuilles 01
Lascia 01
Blätter 01



Hojas 02
Leaves 02
Feuilles 02
Lascia 02
Blätter 02



Hojas 03
Leaves 03
Feuilles 03
Lascia 03
Blätter 03



Flores
Flower
Fleurs
Fiori
Blumen

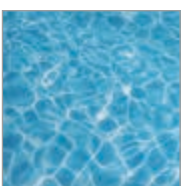

Piscina
Pool water
Piscine
Piscina
Schwimmbad



Ola
Wave
Onde
Onde de mer
Meereswelle



Gotas
Drops
Gouttes
Gocce
Tropfen

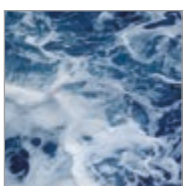

Mar
Sea
Mer
Mare
Meer

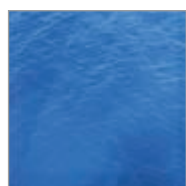

Calma
Calm down
Calmer
Calmati
Sich beruhigen



Zen 01
Zen 01
Zen 01
Zen 01
Zen 01



Zen 02
Zen 02
Zen 02
Zen 02
Zen 02



Zen 03
Zen 03
Zen 03
Zen 03
Zen 03

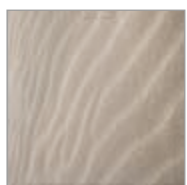

Zen 04
Zen 04
Zen 04
Zen 04
Zen 04



Circulos
Circle
Cercles
Cerchi
Kreise



Puntos
Dots
Points
Punti
Punkte



Nordic
Nordic
Nordic
Nordic
Nordic



Acuarela
Watercolor
Aquarelle
Acquerello
Aquarell



DUPLACH group®

SOLUCIONES PARA:

PANELES DE DUCHA
CAMBIO DE BAÑERA A DUCHA
DISEÑOS IMPOSIBLES
COLORES ATREVIDOS
ORGANIZACION CON ACCESORIOS OHU

SHOWER PANELS
BATHTUB CHANGE TO SHOWER
IMPOSSIBLE DESIGNS
DARE COLORS
ORGANIZATION WITH OHU ACCESSORIES

PANNEAUX DE DOUCHE
CHANGEMENT DE BAIGNOIRE A DOUCHE
CONCEPTIONS IMPOSSIBLES
DARE COULEURS
ORGANISATION AVEC ACCESSOIRES OHU

PANNELI DOCCIA
CAMBIAMENTO DA VASCA A DOCCIA
DARE COLORS
DISEGNI IMPOSSIBILI
ORGANIZZAZIONE CON ACCESSORI OHU

DUSCHPANEELE
WECHSELN VON DER BADEWANNE ZUR DUSCHE
UNMÖGLICHE DESIGNS
GEWAGTE FARBEN
ORGANISATION MIT ZUBEHÖR OHU

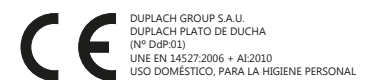



El revestimiento de paredes con nuestros paneles se realiza de forma rápida y sencilla, de igual manera que el plato de ducha, preparando primero la superficie con mortero en la pared y aplicando adhesivo de poliuretano en el panel. Consiguiendo un resultado óptimo en poco tiempo.



The wall cladding with our panels is done quickly and easily, in the same way as the shower tray, first preparing the surface with mortar on the wall and applying polyurethane adhesive to the panel. Achieving optimal results in a short time.



Le revêtement mural avec nos panneaux se fait rapidement et facilement, de la même manière que le receveur de douche, en préparant d'abord la surface avec du mortier sur le mur et en appliquant de la colle polyuréthane sur le panneau. Obtenir des résultats optimaux en peu de temps.

Il rivestimento murale con i nostri pannaux si fa in modo rapido e semplice, dalla stessa maniera che riceviamo dalla doccia, in preparazione della superficie con la mortasa a parete e sull'applicatore della colle in poliuretano sul pannello. Ottieni i risultati ottimali in termini di temp.

Die Wandverkleidung mit unseren Pannaux, wenn sie schnell und einfach durchgeführt wird, ergibt die stessa manière, die wir aus der Lehre gelernt haben, bei der Vorbereitung der Oberfläche mit dem Mörtel auf der Wand und ihrem Applikator des Colle in Polyurethan auf dem Pannello. Ottieni i risultati ottimali in termini di temp.



Nuestros paneles permiten la instalación tanto en vertical y como en horizontal adaptándose a su espacio y diseño.



Our panels allow installation both vertically and horizontally, adapting to your space and design.



Nos panneaux permettent une installation à la fois verticale et horizontale, s'adaptant à votre espace et à votre design.

I nostri pannelli consentono l'installazione sia in verticale che in orizzontale, adattandosi al tuo spazio e al tuo design.

Unsere Panele ermöglichen eine vertikale und horizontale Installation und passen sich Ihrem Raum und Design an.



El uso de paneles de revestimiento facilita el trabajo de renovar el baño e incluso de cambiar la bañera por un plato de ducha de forma fácil y cómoda, con diferentes opciones de diseño y acabados.

The use of cladding panels facilitates the work of renovating the bathroom and even changing the bathtub for a shower tray in an easy and comfortable way, with different design options and finishes.



L'utilisation de panneaux de revêtement facilite les travaux de rénovation de la salle de bain et même de changement de la baignoire pour un receveur de douche de manière simple et confortable, avec différentes options de conception et finitions.



L'utilizzo dei pannelli di rivestimento facilita i lavori di ristrutturazione del bagno e persino di sostituire la vasca da bagno con un piatto doccia in modo facile e comodo, con diverse opzioni di design e finiture.

Die Verwendung von Verkleidungsplatten erleichtert die Renovierung des Badezimmers und sogar den Austausch der Badewanne gegen eine Duschwanne auf einfache und komfortable Weise mit verschiedenen Gestaltungsmöglichkeiten und Oberflächen.



Medidas 80 y 90 incluidos con radio 50 cm.
Otras medidas y radios incremento de 50€ PVP.

Measures 80 and 90 along with radius 50 cm. Other measures and radios mean a € 50 sales price increase/each

Mesure 80 et 90 inclus avec un rayon de 50 cm.
Les autres mesures et rayon augmentent de 50 € Prix Public

Misure 80 e 90 comprese con raggio di 50 cm.
Altre misure e raggio aumento di € 50 PVP.

Radiuskurve von 50 cm bei den Maßen 80 cm und 90 cm ohne Aufpreis.
Andere Maße und Radius mit Aufpreis von 50 € Verkaufspreis.

Adaptamos el diseño del plato a cualquier forma.
Incluido en precio.

Trays adaptable to non-standard shapes. Included in price.

Nous adaptons le design du plat à toutes les formes.
Inclus dans le prix.

Sagoniamo e adattiamo il piatto a qualsiasi richiesta.
Compreso nel prezzo.

Wir passen das Design der Duschwanne an jede Form an. Im Preis
inbegriffen.

La fabricación se realiza con la masa coloreada en los tonos de nuestra carta de color. Podemos realizar la pieza en cualquier color de la carta RAL con incremento.

Los productos realizados con colores diferentes a los de nuestra carta de color están exentos de devolución.

Made from a coloured mass base in the colour tones of our chart that best suit the design, a unique digital printing system is applied on the upper layer with a design that offers endless possibilities for bespoke and durable outcomes. Our GEL COAT covering ensures that high durability.

Products made with colours other than our colour chart ones can not be returned.

La fabrication se fait avec la masse colorée dans les teintes de notre nuancier. Nous pouvons réaliser la pièce dans n'importe quelle couleur de la carte RAL avec incrément.

Les produits fabriqués avec des couleurs différentes de notre nuancier sont exemptés de retour.

La produzione viene effettuata con la massa colorata nelle tonalità della nostra cartella colori. Possiamo realizzare il pezzo in qualsiasi colore dalla tabella RAL con incremento.

I prodotti realizzati in colori diversi da quelli della nostra cartella colori sono esenti da restituzione.

Die Herstellung erfolgt mit dem Teig, der in den Tönen unserer Farbkarte gefärbt ist. Wir können das Stück auch in jeder Farbe des RAL – Diagramms mit Aufpreis herstellen.

Produkte, die mit anderen als den in unserer Farbkarte aufgeführten Farben hergestellt wurden, sind von Rücksendungen ausgenommen.





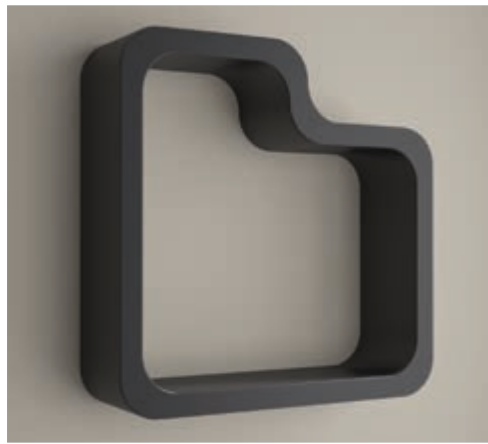

CERTIFICADOS DE CALIDAD · QUALITY CERTIFICATES · CERTIFICATS DE QUALITÉ ·
CERTIFICATI DI QUALITÀ · QUALITÄT SZERTIFIKATE

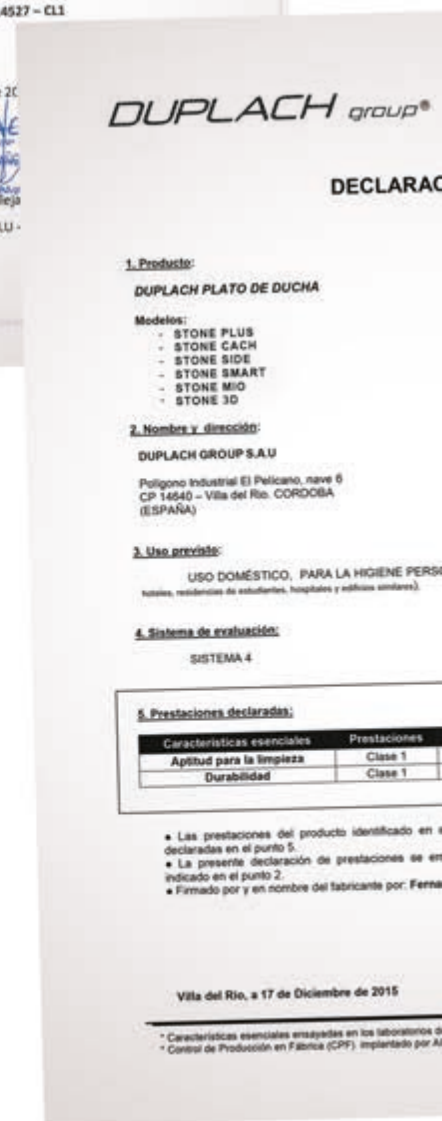



AIDIMA

Referencia: 1511049-02

CERTIFICADO DE ENSAYO

PRODUCTO
Una muestra de revestimiento de plato de ducha de color blanco, construida con material polimérico, identificada por el cliente como:

- REVESTIMIENTO TEXTURA STONE PLUS

EMPRESA:
DUPLACH GROUP S.A.U
C/ LIBERTAD 7
14640 VILLA DEL RIO (CORDOBA)
B-14.952.28.81

ENSAYO
Deslizamiento/resbaladicidad según UNE ENV 12633:2003.

RESULTADO
Según consta en el informe de referencia 1511049-02 (fecha de emisión: 11 de diciembre de 2015), los resultados obtenidos fueron los siguientes:

ENSAYOS REALIZADOS	MET. ENSAYO	RESULTADO
USRV (valor de la resistencia al deslizamiento sin pulir)	UNE ENV 12633:2003	37
Clase de resbaladicidad *		CLASE 3

(*) Por analogía y considerando el Código Técnico de Edificación - CTE - (aplicable a edificios), en vigor desde 28 de marzo de 2006 y modificación conforme a la Ley 8/2007, de junio, de "Rehabilitación, regeneración y renovación urbana", los suelos se clasifican su resistencia al deslizamiento, de acuerdo con la norma UNE ENV 12633:2003 y el ensayo en húmedo.

Paterna, 23 de diciembre de 2015



Dra. Rosa Mª Pérez Campos
Directora Dpto. de Materiales
AIDIMA

De las muestras ensayadas en el Laboratorio de AIDIMA

Red Europea de Innovación para la Industria Forestal, de la que forman parte: BIRI-CTIC (Reino Unido), CATAS SPA (Italia), COSMOS (Grecia), FCSA (Francia), IFO (Alemania), ITO (Polonia), S1 (Reino Unido), UBC-DWIS (Canadá), University of Zagreb (Croacia).



DECLARACIÓN DE PRESTACIONES
Nº. DdP: 01

PERSONAL. (Dentro del uso doméstico se incluye la utilización en...

Normas	Especificaciones Técnicas Armonizadas
1	EN 14527:2006 + A1:2010
1	EN 14527:2006 + A1:2010

do en el punto 1 son conformes con las prestaciones...
se emite bajo la única responsabilidad del fabricante.
r. Fernando Navas Molléja

(Gerente)

laboratorio de AIDIMA
certificado por AIDIMA.



AIDIMA

Referencia: 1511049-01

CERTIFICADO DE ENSAYO

PRODUCTO
Una muestra de plato de ducha de color blanco de 120 cm x 70 cm, construida con material polimérico, identificada por el cliente como:

- PLATO DE DUCHA STONE PLUS

EMPRESA:
DUPLACH GROUP S.A.U
C/ LIBERTAD 7
14640 VILLA DEL RIO (CORDOBA)
B-14.952.28.81

ENSAYO
Adecuación a la norma UNE EN 14527:2006+A1:2010: "Platos de ducha para uso doméstico".

RESULTADO
Según consta en el informe de referencia 1511049-01 (fecha de emisión: 16 de diciembre de 2015), los resultados obtenidos fueron los siguientes:

ENSAYOS REALIZADOS	MET. ENSAYO	RESULTADO
Aplicación para la limpieza (valoración)	UNE EN 14527:2006+A1:2010	Correcto
Evacuación del agua (valoración)	UNE EN 14527:2006+A1:2010	Correcto
Estabilidad del fondo (valoración)	UNE EN 14527:2006+A1:2010	Correcto
Resistencia a productos químicos y colorantes (valoración)	UNE EN 14527:2006+A1:2010	Sin deterioro
Resistencia a las variaciones de temperatura (valoración)	UNE EN 14527:2006+A1:2010	Correcto

De acuerdo con los ensayos realizados, se puede asignar a la muestra la CLASE 1, de acuerdo con la norma UNE EN 14527:2006+A1:2010: "Platos de ducha para uso doméstico" al siguiente sistema: **EN 14527-CL1**

Paterna, 23 de diciembre de 2015



Rosa Mª Pérez Campos
Directora Dpto. de Materiales de AIDIMA

De las muestras ensayadas en el Laboratorio de AIDIMA

Red Europea de Innovación para la Industria Forestal, de la que forman parte: BIRI-CTIC (Reino Unido), CATAS SPA (Italia), COSMOS (Grecia), FCSA (Francia), IFO (Alemania), ITO (Polonia), S1 (Reino Unido), UBC-DWIS (Canadá), University of Zagreb (Croacia).

Página 1 de 1



El CLUB EXCELENCIA EN GESTIÓN
concede la certificación internacional:
SELLO EFQM 200
por su GESTIÓN EXCELENTE, INNOVADORA
Y SOSTENIBLE, basada en el Modelo EFQM a:

DUPLACH GROUP

CERTIFICADO Nº: **CEG/22/S200/6**
FECHA DE CONCESIÓN: **05/05/2022**
VIGENCIA CERTIFICADO: **3 años**



Ignacio Babé
Secretario General/ CEO
CLUB EXCELENCIA EN GESTIÓN

MANUAL INSTALACIÓN

SE INSISTE EN QUE SE SIGA ESTE MANUAL DE FORMA RIGUROSA

INSTALACIÓN:

LA INSTALACIÓN SE DEBE REALIZAR POR PERSONAL ESPECIALIZADO.

PARA UNA PERFECTA INSTALACIÓN DEL PLATO DE DUCHA, ES NECESARIO CREAR UNA SUPERFICIE DE APOYO HOMOGÉNEA CON LA COLA PORCELÁNICA FLEXIBLE, NUNCA DE ARENA ÚNICAMENTE, EN TODA LA DIMENSIÓN DEL PLATO. LA BASE DONDE SE VA A COLOCAR EL PLATO DEBE ESTAR PERFECTAMENTE NIVELADA, ALISADA Y SECA.

LA VÁLVULA DE DESAGÜE NO DEBE SOBRESALIR POR ENCIMA DE LA BASE, DE LO CONTRARIO NO DESAGUARÁ CORRECTAMENTE. DESEMBALAR EL PLATO Y COMPROBAR QUE ESTÉ EN PERFECTO ESTADO, USAREMOS LA TAPA SUPERIOR DEL EMBALAJE PARA PROTEGERLO DURANTE LA INSTALACIÓN.

COLOCAREMOS MASILLA DE POLIURETANO EN TODA LA BASE DE APOYO, EL PLATO SE DEBE COLOCAR HACIENDO COINCIDIR EL AGUJERO DEL DESAGÜE CON LA VÁLVULA INSTALADA PREVIAMENTE SEGÚN EL MODELO DE PLATO. TODOS NUESTROS PLATOS SE SIRVEN CON UNA VÁLVULA DE DESAGÜE QUE CUENTA EN SU INTERIOR CON UN BOTE O VASO SIFÓNICO, EL PLATO NO EVACUARÁ SI EN EL CUARTO DE BAÑO HAY INSTALADO UN SEGUNDO BOTE SIFÓNICO. EN ESTE CASO, HAY QUE RETIRAR EL VASO DEL INTERIOR DE LA VÁLVULA.

VERIFICAR QUE EL PLATO DESAGÜE CORRECTAMENTE.

PARA LIMPIAR POSIBLES RESTOS DE OBRA, USAR UN TRAPO SUAVE Y UN DETERGENTE NEUTRO. NO USAR NUNCA ESTROPAJOS NI PRODUCTOS DISOLVENTES, ÁCIDOS O ABRASIVOS.

MANTENIMIENTO:

PARA SU MANTENIMIENTO PERIÓDICO SÓLO PRECISA DE UNA LIMPIEZA REGULAR CON UN PRODUCTO DETERGENTE PH NEUTRO Y ACLARAR ABUNDANTEMENTE CON AGUA HASTA QUE NO QUEDEN RESTOS DEL PRODUCTO DE LIMPIEZA Y SECAR.

PARA ELIMINAR CUALQUIER RESTO DE RESIDUO, BASTA CON PASAR UN PAÑO SUAVE IMPREGNADO DE DETERGENTE PH NEUTRO Y ACLARAR CON ABUNDANTE AGUA.

EVITAR EL USO DE ESTROPAJOS, ASÍ COMO DE ALCOHOLES, ÁCIDOS O PRODUCTOS ABRASIVOS.

INSTALLATION MANUAL

PLEASE, FOLLOW THE INSTRUCTIONS FOR A RIGHT INSTALLATION AND MAINTENANCE.

INSTALLATION:

INSTALLATION MUST BE DONE BY SPECIALIST.

FOR THE PERFECT INSTALLATION OF THE SHOWER TRAY, IT IS NECESSARY TO CREATE A HOMOGENEOUS SUPPORT SURFACE WITH FLEXIBLE CEMENT GLUE, NEVER ONLY SAND UNIQUELY, IN THE WHOLE DIMENSION OF THE SHOWER TRAY. THE SURFACE WHERE THE SHOWER TRAY WILL BE PLACED MUST BE PERFECTLY LEVELED, SMOOTH AND DRY.

THE VALVE CAN NOT BE PLACED HIGHER THAN THE SURFACE, OTHERWISE IT WILL NOT DRAIN CORRECTLY.

UNPACK THE PLATE AND CHECK THAT IT IS IN PERFECT CONDITION, WE WILL USE THE UPPER COVER OF THE PACKING TO PROTECT IT DURING INSTALLATION.

SPREAD POLYURETHANE GLUE ON THE SURFACE, THE SHOWER TRAY MUST BE PLACED MATCHING THE DRAIN HOLE WITH THE VALVE PREVIOUSLY INSTALLED. ALL OUR SHOWER TRAYS ARE SERVED WITH OUR VALVE ; IT HAS A POT OR A SIPHON INSIDE. THE SHOWER TRAY WILL NOT CORRECTLY DRAIN IF A SECOND SIPHON IS INSTALLED. IN THIS CASE, THE TUBE MUST BE REMOVED FROM THE INSIDE VALVE.

CHECK THAT THE SHOWER TRAYS DRAINS PROPERLY.

FOR CLEANING ANY RESIDUE, USE A SOFT CLOTH AND A PH NEUTRAL DETERGENT. DO NOT USE SPONGE OR SOLVENT, ACID OR ABRASIVE PRODUCTS.

MAINTENANCE:

CLEAN REGULARLY WITH A PH NEUTRAL DETERGENT, RINSE ABUNDANTLY WITH WATER UNTIL THERE IS NO RESIDUE OF DETERGENT AND DRY.

TO REMOVE ANY RESIDUE, SIMPLY WIPE WITH A CLEAN CLOTH AND PH NEUTRAL DETERGENT, RINSE WITH ABUNDANT WATER.

AVOID THE USE OF SCOURING SPONGE AS WELL AS ALCOHOLS, ACIDS OR ABRASIVE PRODUCTS.

MANUEL D'INSTALLATION

NOUS VOUS PRIONS DE SUIVRE RIGOREUSEMENT LES INSTRUCTIONS DE CE MANUEL

INSTALLATION:

L'INSTALLATION SERA RÉALISÉE PAR LE PERSONNEL SPÉCIALISÉ.

POUR UNE INSTALLATION CORRECTE DU RECEVEUR, PRÉVOIR UNE SURFACE HOMOGÈNE DE COLLE DE POLYURÉTHANE FLEXI, JAMAIS SOULEMENT DE SABLE, DANS TOUTE LA DIMENSION DU RECEVEUR DE DOUCHE. LA BASE OU LE RECEVEUR SERA PLACÉ ETRE PARFAITEMENT, NIVELEE ET SECHE.

LA BONDE NE PEUT PAS DÉPASSER PAR-DESSUS LA BASE OU L'ÉCOULEMENT DE L'EAU NE SERA PAS LE CORRECTE.

DEBALLER LE RECEVEUR ET CONSERVER L'EMBALLAGE POUR PROTÉGER LE RECEVEUR DE DOUCHE DURANT L'INSTALLATION.

UTILISER UNE PÂTE DE POLYURÉTHANE POUR FIXER LE RECEVEUR AU SOL. PLACER LE RECEVEUR EN FAISANT COÏNCIDER LE TROU DU SIPHON AVEC LA BONDE PRÉALABLEMENT INSTALLÉE SELON LE MODÈLE DU RECEVEUR. TOUS NOS RECEVEURS SONT LIVRÉS AVEC BONDE. NE UTILISER PAS UNE AUTRE BONDE QUE CELLE FOURNIE.

POUR NETTOYER LES RESTES, UTILISER UN TISSU DOUX AVEC UN DÉTERGENT PH NEUTRE. N'UTILISER JAMAIS UN CHIFFON RÂPEUX NI DES PRODUITS DISSOLVANTS, ACIDES OU ABRASIFS.

MAINTENANCE:

POUR UN NETTOYAGE FRÉQUENT, NETTOYER A L'AIDE D'UN CHIFFON DOUX ET DE L'EAU SAVONNEUSE OU UTILISER UN PRODUIT DE NETTOYAGE AU PH NEUTRE CONFORME. RINCER ABONDAMMENT AVEC DE L'EAU ET SÉCHER.

POUR ÉLIMINER DES DÉCHETS, NETTOYER AVEC UN CHIFFON DOUX IMPRÉGNÉ D'UN DETERGENT PH NEUTRE. RINCER ABONDAMMENT AVEC DE L'EAU.

ÉVITER L'USAGE DES CHIFFONS RÂPEUX ET DES PRODUITS DISSOLVANTS, ACIDES OU ABRASIFS.

¡¡¡ATENCIÓN INSTALADOR!!!

SIGA LAS INSTRUCCIONES DE NIVELACIÓN DEL PLATO



¡¡¡IMPORTANTE !!

DESPUÉS DE LA COLOCACIÓN DEL PLATO DE DUCHA SE RUEGA QUE SE CUBRA O TAPÉ, ASÍ SE EVITARÁN LAS POSIBLES INCIDENCIAS DURANTE LA COLOCACIÓN DE AZULEJOS, COLUMNAS DE HIDROMASAJE, GRIFERÍAS, MAMPARAS, ETC.

ANTES DE TERMINAR ALICATADO Y COLOCAR CUALQUIER TIPO DE MATERIAL SOBRE EL MISMO, EL INSTALADOR DEBERÁ VERIFICAR LA CORRECTA INSTALACIÓN Y CONTROLAR QUE EL PLATO DESAGÜE CORRECTAMENTE, ASÍ MISMO, EL INSTALADOR TIENE LA POSIBILIDAD DE MODIFICAR SU CALDA HASTA SU PLENTO DESAGÜE ANTES DE QUE FRAGUE EL MORTERO.

EN CASO DE NO HACER CORRECTAMENTE ESTA VERIFICACIÓN, EL FABRICANTE NO SE HARÁ CARGO DE LOS GASTOS DERIVADOS DE LA SUSTITUCIÓN, MAMPARAS O CERÁMICAS COLOCADAS SOBRE EL PLATO

ATTENTION FITTER!!!

Follow the instructions for levelling the tray



¡¡¡IMPORTANT !!

AFTER PLACING THE SHOWER TRAY, IT MUST BE COVERED TO AVOID ANY INCIDENT WHILE TILING OR INSTALLING THE HYDRO-MASSAGE COLUMN, TAPS, SCREENS,...

AFTER TILING, IT SHOULD BE CHECK THAT THE SHOWER TRAY HAS CORRECTLY BEEN INSTALLED AND CHECK THAT IT PROPERLY DRAINS. THE INSTALLER CAN MODIFY THE SLOPE FOR A CORRECT DRAINING BEFORE THE MORTAR IS DRY.

IN THE EVENT OF CARRYING OUT THIS VERIFICATION INCORRECTLY, THE MANUFACTURER WILL NOT BE RESPONSIBLE FOR THE COST OF REPLACING THE SHOWER TRAY SCREEN OR TILES.

ATTENTION INSTALLATEUR!!!

Suivez les instructions pour niveler le receveur



¡¡¡IMPORTANT !!

APRÈS LE PLACEMENT DU RECEVEUR DE DOUCHE, NOUS VOUS PRIONS DE LE CACHER POUR ÉVITER LES POSSIBLES INCIDENCES PENDANT LE PLACEMENT DES CARREAUX, COLONNES D'HYDRO-MASSAGE, ROBINETTERIE, PARE-DOUCHES, ETC.

AVANT DE POSER LE CARRELAGE, L'INSTALLATEUR DOIT VÉRIFIER LA CORRECTE INSTALLATION ET CONTRÔLER QUE LE RECEVEUR DRAIN CORRECTEMENT. L'INSTALLATEUR A LA POSSIBILITÉ DE MODIFIER LA PENTE DU RECEVEUR POUR QUE LE RECEVEUR DRAIN PARFAITEMENT AVANT QUE LE CIMENT PRENNE.

SI VOUS NE SUIVEZ PAS CE MANUEL, LE FABRICANT NE SERA PAS RESPONSABLE DE DÉPENSES CAUSÉES POUR LE REMPLACEMENT DU RECEVEUR, PARE-DOUCHES O DES CARREAUX PLACÉS SUR LE RECEVEUR.

MANUALE D'INSTALLAZIONE

SI PREGA DI ATTENERSI SCRUPolosAMENTE ALLE ISTRUZIONI DI QUESTO MANUALE

L'INSTALLAZIONE:

L'INSTALLAZIONE DEVE ESSERE REALIZZATA DA PROFESSIONISTI.

PER UNA PERFETTA INSTALLAZIONE DEL PIATTO DOCCIA È RICHIESTO DI CREARE UNA SUPERFICIE DI SUPPORTO UNIFORME CON COLLA DI POLIURETANO FLESSIBILE, MAI SOLTANTO DI SABBIA, PARI ALLE DIMENSIONI DELLO STESSO PIATTO. LA BASO CUI SARÀ INSTALLATA LA DOCCIA ESSERE PERFETTAMENTE PIANNA, LISCIA E ASCIUTTA.

LO SCARICO NON PUÒ SPORGERE DALLA BASE, ALTRIMENTI NON SCARICHERÀ IN MODO CORRETTO.

SBALLIAMO IL PIATTO E UTILIZZIAMO L'IMBALLAGGIO PER LA PROTEZIONE DEL PIATTO DURANTE L'INSTALLAZIONE.

METTERE MASTICE DI POLIURETANO PER CREARE LA BASE. IL PIATTO DEVE ESSERE POSIZIONATO ABBINANDO IL BUCO DELLO SCARICO CON LA VALVOLA INSTALLATA SECONDO IL MODELLO DEL PIATTO, TUTTI I NOSTRI PIATTI SONO FORNITI CON VALVOLA DI SCARICO, DOTATO ALL'INTERNO DI UNA VASCA O SIFONE. IL PIATTO NON SCARICHERÀ SE C'È INSTALLATO UN SECONDO SIFONE, IN QUESTO CASO LA VASCA DOVRÀ ESSERE RIMOSSA DALL'INTERNO.

CONTROLLARE CHE IL PIATTO SCARICHI CORRETTAMENTE E SIA A LIVELLO.

PER PULIRE I RESIDUI, UTILIZZARE UN PANNO MORBIDO ED UN DETERGENTE PH NEUTRO. NON USARE MAI STROFINACCI NE PRODOTTI SOLVENTI, ACIDI O ABRASIVI.

MANUTENZIONE:

PER LA MANUTENZIONE REGOLARE È NECESSARIO PULIZIA CON PRODOTTO PH NEUTRO. RISCIAQUARE ABBONDANTEMENTE CON ACQUA PER ELIMINARE I RESTI DI PRODOTTI DI PULIZIA ED ASCIUGARE.

PER RIMUOVERE EVENTUALI RESIDUI PASSARE UN PANNO MORBIDO IMPREGNATO CON DETERGENTE PH NEUTRO E RISCIAQUARE ABBONDANTEMENTE.

EVITARE IL USO DI ALCOLI, ACIDI O PRODOTTI ABRASIVI.

INSTALLATIONSANLEITUNG

ES WIRD DARAUF BESTANDEN, DASS DIESES HANDBUCH GENAU BEFOLGT WIRD.

INSTALLATION:

DIE INSTALLATION MUSS VON FACHPERSONAL DURCHFÜHRT WERDEN.

FÜR EINE PERFERTE INSTALLATION DER DUSCHWANNE IST ES ERFORDERLICH, EINE HOMOGENE AUFLAGEFLÄCHE MIT FLEXIBLEM PORZELLANKLEBER, NIEMALS NUR AUS SAND, IN DER GESAMTEN ABMESSUNG DER WANNE ZU SCHAFFEN. DIE BASIS AUF DER DIE PLATTE PLATZIERT WERDEN SOLL, MUSS PERFERKT EBEN, ISOLIERT UND TROCKEN SEIN.

DAS ABLASSVENTIL DARF NICHT ÜBER DEN BODEN HINAUSRAGEN, DA SONST DAS WASSER NICHT ABLÄUFT.

PACKEN SIE DIE DUSCHWANNE AUS UND PRÜFEN SIE, OB SIE IN EINWANDFREIEM ZUSTAND IST. VERWENDEN SIE DIE OBERE ABDECKUNG DER VERPACKUNG, UM SIE WÄHREND DER INSTALLATION ZU SCHÜTZEN.

WIR TRAGEN POLYURETHAN KLEBER AUF DIE GESAMTE STÜTZBASIS. DIE PLATTE MUSS SO PLATZIERT WERDEN, INDEM DAS ABFLUSSLOCH MIT DEM ZUVOR INSTALLIERTEN VENTIL GEMÄß DEM PLATTENMODELL ÜBEREINSTIMMT. ALLE UNSERE PLATTEN WERDEN MIT EINEM ABLASVENTIL GELIEFERT, IN DEM SICH EIN SIPHON ODER EIN TOPF BEFINDET. DIE DUSCHPLATTE EVAKUIERT NICHT, WENN EIN ZWEITES SIPHON IM BADEZIMMER INSTALLIERT IST. IN DIESEM FALL MUSS DER INNERE SIPHON VOM VENTIL ENTFERNT WERDEN.

ÜBERPRÜFERN SIE OB DAS WASSER RICHTIG ABLÄUFT.

VERWENDEN SIE ZUM REINIGEN MÖGLICHER ARBEITSRESTE EIN WEICHES TUCH UND EIN NEUTRALES REINIGUNGSMITTEL. VERWENDEN SIE NIEMALS SCHEURSCHWÄMME ODER LÖSUNGSMITTEL, SÄUREN ODER SCHLEIFMITTEL.

INSTANDHALTUNG:

FÜR DIE PFLEGE IST NUR EINE REGELMÄßIGE REINIGUNG MIT EINEM PH NEUTRALEM REINIGUNGSMITTEL NÖTIG. GRÜNDLICH MIT WASSER ABSPÜLEN, BIS KEINE REINIGUNGSMITTELRESTE MEHR VORHANDEN SIND, UND TROCKNEN.

UM RÜCKSTÄNDE ZU ENTFERNEN, WISCHEN SIE SIE EINFACH MIT EINEM WEICHEN TUCH AB, DAS MIT PH NEUTRALEM REINIGUNGSMITTEL IMPRÄGNIERT IST, UND SPÜLEN SIE SIE MIT VIEL WASSER AB.

VERMEIDEN SIE SCHEURSCHWÄMME, ALKOHOLE, SÄUREN ODER SCHLEIFMITTEL.



VÍDEO INSTALACIÓN
INSTALLATION VIDEO
VIDÉO D'INSTALLATION
VIDEO DI INSTALLAZIONE
INSTALLATIONSVIDEO



EMBALAGE · PACKAGING · EMBALLAGE · CONFEZIONE · VERPACKUNG



Nuestro packaging incluye en su interior junto a las instrucciones de montaje y el plato de ducha, la válvula y la rejilla. Recibiendo de esta manera un sólo bulto, más práctico y sostenible.

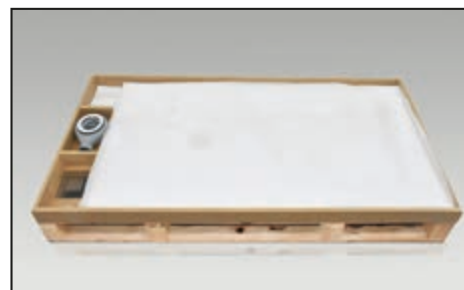

Our packaging includes inside, together with the assembly instructions and the shower tray, the valve and the grid. Receiving in this way a single package, more practical and sustainable.



Notre emballage comprend à l'intérieur, avec les instructions de montage et le receveur de douche, la vanne et la grille. Recevoir ainsi un colis unique, plus pratique et écologique.

Il nostro imballo comprende al suo interno, insieme alle istruzioni di montaggio e al piatto doccia, la valvola e la griglia. Ricevendo così un unico pacchetto, più pratico e sostenibile.

Unsere Verpackung enthält im Inneren zusammen mit der Montageanleitung und der Duschwanne das Ventil und das Gitter. Auf diese Weise erhalten Sie ein einziges Paket, praktischer und ökologischer.

TARIFA · PRICE LIST · TARIF · LISTINO PREZZI · PREISLISTE

DUPLACH group®

Tlf. **+34 957 176 316** · Móvil: **+34 687 466 686** 

Ctra. de Cardeña Km 8, 14640 · Villa del Río · CÓRDOBA · España

info@duplach.com | www.duplach.com