

*Revisión A*

**23/01**



# TARIFA DE PRECIOS

Batsur S.L.

FORMATO DIGITAL



Revisión A



**Revisión A**  
**23/01**

**MOD.BS TP 01.01.23 (A)**

# BATERÍAS

Revisión A

**23/01**

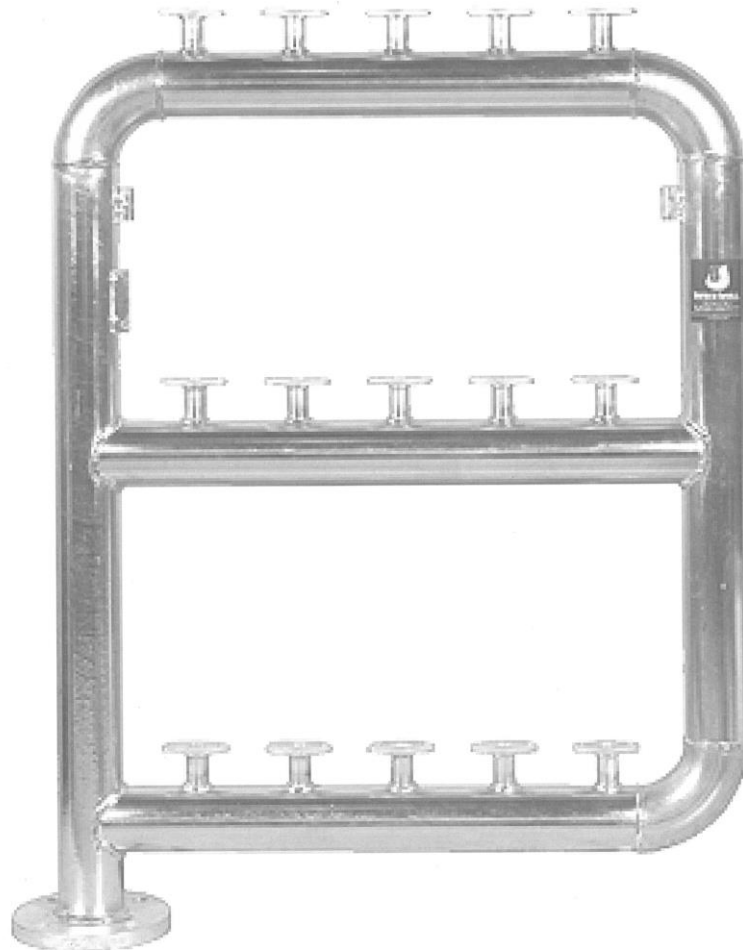

Revisión A

**ÍNDICE**

**PAG. 5-26..... BATERÍAS PARA CENTRALIZACIÓN DE CONTADORES**

**PAG. 27-33..... ACCESORIOS PARA CENTRALIZACIÓN DE CONTADORES**

**PAG. 34..... ACCESORIOS PARA GRUPOS DE PRESIÓN**

**PAG. 35..... TORNILLERÍA**

Revisión A

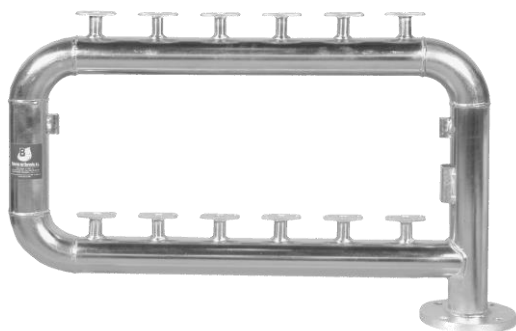

**BATERÍAS ACERO GALVANIZADO MODELO CUADRO CIRCUITO CERRADO 2 FILAS**

N° CONTADORES	FILAS	PULGADAS	REF.	EUROS	PESO UNID.
4	2	2"	20042	170,60	12,000
6	2	2"	20062	195,16	13,500
8	2	2 1/2"	20082	268,73	18,000
10	2	2 1/2"	20102	295,88	20,000
12	2	2 1/2"	20122	321,06	21,500
14	2	2 1/2"	20142	347,29	23,000
16	2	2 1/2"	20162	373,43	24,500
18	2	2 1/2"	20182	400,68	26,000
20	2	2 1/2"	20202	425,20	27,500
22	2	2 1/2"	20222	450,20	29,000
24	2	2 1/2"	20242	473,75	30,500
26	2	2 1/2"	20262	504,14	32,000
28	2	2 1/2"	20282	532,07	33,500
30	2	2 1/2"	20302	555,29	35,000

INCLUIDO KIT DE MONTAJE

**BATERÍAS ACERO GALVANIZADO MODELO CUADRO CIRCUITO CERRADO 3 FILAS**

N° CONTADORES	FILAS	PULGADAS	REF.	EUROS	PESO UNID.
6	3	2"	30063	233,51	16,500
9	3	2 1/2"	30093	342,17	24,000
12	3	2 1/2"	30123	377,95	26,000
15	3	2 1/2"	30153	417,42	28,500
18	3	2 1/2"	30183	459,01	31,000
21	3	2 1/2"	30213	497,64	33,000
24	3	2 1/2"	30243	536,22	35,000
27	3	2 1/2"	30273	576,85	37,000
30	3	2 1/2"	30303	613,65	39,500
33	3	3"	30333	779,21	55,000
36	3	3"	30363	830,12	58,000
39	3	3"	30393	884,53	62,000
42	3	3"	30423	933,29	65,500
45	3	3"	30453	981,63	69,000

INCLUIDO KIT DE MONTAJE

Revisión A

**BATERÍAS ACERO GALVANIZADO  
 MODELO CUADRO CIRCUITO CERRADO 2 FILAS SUPERIOR**

N° CONTADORES	FILAS	PULGADAS	REF.	EUROS	PESO UNID.
4	2	2"	20042S	184,32	12,000
6	2	2"	20062S	210,87	13,500
8	2	2 1/2"	20082S	290,31	18,000
10	2	2 1/2"	20102S	319,67	20,000
12	2	2 1/2"	20122S	346,91	21,500
14	2	2 1/2"	20142S	375,27	23,000
16	2	2 1/2"	20162S	403,46	24,500
18	2	2 1/2"	20182S	432,93	26,000
20	2	2 1/2"	20202S	459,40	27,500
22	2	2 1/2"	20222S	486,45	29,000
24	2	2 1/2"	20242S	511,83	30,500
26	2	2 1/2"	20262S	544,72	32,000
28	2	2 1/2"	20282S	574,84	33,500
30	2	2 1/2"	20302S	599,90	35,000

INCLUIDO KIT DE MONTAJE

**BATERÍAS ACERO GALVANIZADO  
 MODELO CUADRO CIRCUITO CERRADO 3 FILAS SUPERIOR**

N° CONTADORES	FILAS	PULGADAS	REF.	EUROS	PESO UNID.
6	3	2"	30063S	252,29	16,500
9	3	2 1/2"	30093S	369,68	24,000
12	3	2 1/2"	30123S	408,41	26,000
15	3	2 1/2"	30153S	450,95	28,500
18	3	2 1/2"	30183S	495,90	31,000
21	3	2 1/2"	30213S	537,68	33,000
24	3	2 1/2"	30243S	579,37	35,000
27	3	2 1/2"	30273S	623,24	37,000
30	3	2 1/2"	30303S	662,92	39,500
33	3	3"	30333S	831,38	55,000
36	3	3"	30363S	885,94	58,000
39	3	3"	30393S	943,86	62,000
42	3	3"	30423S	995,95	65,500
45	3	3"	30453S	1.047,19	69,000

INCLUIDO KIT DE MONTAJE

Revisión A

**BATERÍAS ACERO GALVANIZADO  
MODELO CUADRO CIRCUITO CERRADO 2 FILAS LATERAL INFERIOR Y SUPERIOR**



Nº CONTADORES	FILAS	PULGADAS	REF. INFERIOR	EUROS	REF. SUPERIOR	EUROS	PESO UNID.
4	2	2"	20042LI	201,97	20042LS	201,97	12,000
6	2	2"	20062LI	229,23	20062LS	229,23	13,500
8	2	2 1/2"	20082LI	310,83	20082LS	310,83	18,000
10	2	2 1/2"	20102LI	340,84	20102LS	340,84	20,000
12	2	2 1/2"	20122LI	368,74	20122LS	368,74	21,500
14	2	2 1/2"	20142LI	397,85	20142LS	397,85	23,000
16	2	2 1/2"	20162LI	426,89	20162LS	426,89	24,500
18	2	2 1/2"	20182LI	457,02	20182LS	457,02	26,000
20	2	2 1/2"	20202LI	484,01	20202LS	484,01	27,500
22	2	2 1/2"	20222LI	512,14	20222LS	512,14	29,000
24	2	2 1/2"	20242LI	537,95	20242LS	537,95	30,500
26	2	2 1/2"	20262LI	571,57	20262LS	571,57	32,000
28	2	2 1/2"	20282LI	602,55	20282LS	602,55	33,500
30	2	2 1/2"	20302LI	628,24	20302LS	628,24	35,000

INCLUIDO KIT DE MONTAJE

**BATERÍAS ACERO GALVANIZADO  
MODELO CUADRO CIRCUITO CERRADO 3 FILAS LATERAL INFERIOR Y SUPERIOR**



Nº CONTADORES	FILAS	PULGADAS	REF. INFERIOR	EUROS	REF. SUPERIOR	EUROS	PESO UNID.
6	3	2"	30063LI	271,67	30063LS	271,67	16,500
9	3	2 1/2"	30093LI	392,11	30093LS	392,11	24,000
12	3	2 1/2"	30123LI	432,02	30123LS	432,02	26,000
15	3	2 1/2"	30153LI	475,84	30153LS	475,84	28,500
18	3	2 1/2"	30183LI	521,94	30183LS	521,94	31,000
21	3	2 1/2"	30213LI	564,36	30213LS	564,36	33,000
24	3	2 1/2"	30243LI	607,26	30243LS	607,26	35,000
27	3	2 1/2"	30273LI	652,20	30273LS	652,20	37,000
30	3	2 1/2"	30303LI	693,25	30303LS	693,25	39,500
33	3	3"	30333LI	899,42	30333LS	899,42	55,000
36	3	3"	30363LI	957,76	30363LS	957,76	58,000
39	3	3"	30393LI	1.019,15	30393LS	1.019,15	62,000
42	3	3"	30423LI	1.074,59	30423LS	1.074,59	65,500
45	3	3"	30453LI	1.129,66	30453LS	1.129,66	69,000

INCLUIDO KIT DE MONTAJE

Revisión A

**BATERÍAS ACERO GALVANIZADO**  
**MODELO CUADRO CIRCUITO CERRADO 2 FILAS CENTRAL Y CENTRAL SUPERIOR Y/O ACODADA**



N° CONTADORES	FILAS	PULGADAS	REF. CENTRAL	EUROS	REF. CENTRAL SUPERIOR	EUROS	PESO UNID.
4	2	2"	20042C	211,22	20042CS	211,22	12,000
6	2	2"	20062C	244,26	20062CSA	244,51	13,500
8	2	2 1/2"	20082C	325,53	20082CS	325,53	18,000
10	2	2 1/2"	20102C	353,83	20102CSA	371,72	20,000
12	2	2 1/2"	20122C	383,71	20122CS	383,71	21,500
14	2	2 1/2"	20142C	403,99	20142CSA	420,31	23,000
16	2	2 1/2"	20162C	440,45	20162CS	439,75	24,500
18	2	2 1/2"	20182C	469,18	20182CSA	487,94	26,000
20	2	2 1/2"	20202C	498,61	20202CS	499,03	27,500
22	2	2 1/2"	20222C	521,45	20222CSA	543,09	29,000
24	2	2 1/2"	20242C	553,48	20242CS	552,94	30,500
26	2	2 1/2"	20262C	600,43	20262CSA	610,98	32,000
28	2	2 1/2"	20282C	617,83	20282CS	616,64	33,500
30	2	2 1/2"	20302C	640,70	20302CSA	659,24	35,000

INCLUIDO KIT DE MONTAJE

**BATERÍAS ACERO GALVANIZADO**  
**MODELO CUADRO CIRCUITO CERRADO 3 FILAS CENTRAL Y CENTRAL SUPERIOR Y/O ACODADA**

Revisión A



N° CONTADORES	FILAS	PULGADAS	REF. CENTRAL	EUROS	REF. CENTRAL SUPERIOR	EUROS	PESO UNID.
6	3	2"	30063C	280,88	30063CS	280,94	16,500
9	3	2 1/2"	30093C	406,69	30093CSA	423,06	24,000
12	3	2 1/2"	30123C	446,60	30123CS	446,60	26,000
15	3	2 1/2"	30153C	493,54	30153CSA	508,33	28,500
18	3	2 1/2"	30183C	536,73	30183CS	536,43	31,000
21	3	2 1/2"	30213C	578,33	30213CSA	595,44	33,000
24	3	2 1/2"	30243C	620,91	30243CS	622,06	35,000
27	3	2 1/2"	30273C	658,78	30273CSA	676,70	37,000
30	3	2 1/2"	30303C	707,98	30303CS	707,98	39,500
33	3	3"	30333C	923,88	30333CSA	943,49	55,000
36	3	3"	30363C	979,27	30363CS	979,27	58,000
39	3	3"	30393C	1.039,25	30393CSA	1.059,26	62,000
42	3	3"	30423C	1.094,16	30423CS	1.094,21	65,500
45	3	3"	30453C	1.155,18	30453CSA	1.168,03	69,000

INCLUIDO KIT DE MONTAJE



**BATERÍAS ACERO GALVANIZADO**  
**MODELO CUADRO CIRCUITO CERRADO 2 FILAS CON DOBLE ALIMENTACIÓN**

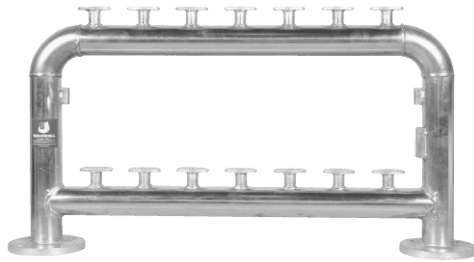

Nº CONTADORES	FILAS	PULGADAS	REF.	EUROS	PESO UNID.
18	2	2 1/2"	40182	444,42	33,000
20	2	2 1/2"	40202	468,31	34,500
22	2	2 1/2"	40222	492,67	36,000
24	2	2 1/2"	40242	515,62	37,500
26	2	2 1/2"	40262	540,08	39,000
28	2	2 1/2"	40282	572,45	40,500
30	2	2 1/2"	40302	595,07	42,000

INCLUIDO KIT DE MONTAJE

**BATERÍAS ACERO GALVANIZADO**  
**MODELO CUADRO CIRCUITO CERRADO 3 FILAS CON DOBLE ALIMENTACIÓN**

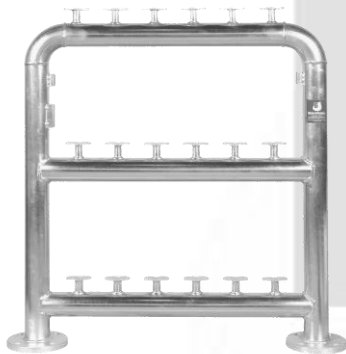

Nº CONTADORES	FILAS	PULGADAS	REF.	EUROS	PESO UNID.
18	3	2 1/2"	50183	500,97	38,000
21	3	2 1/2"	50213	538,60	40,000
24	3	2 1/2"	50243	576,20	42,000
27	3	2 1/2"	50273	615,79	44,000
30	3	2 1/2"	50303	651,65	46,000
33	3	3"	50333	838,74	63,000
36	3	3"	50363	888,08	66,500
39	3	3"	50393	941,32	70,500
42	3	3"	50423	989,74	74,000
45	3	3"	50453	1.045,54	77,500

INCLUIDO KIT DE MONTAJE

Revisión A

### BATERÍAS VERSIÓN ACERO GALVANIZADO 1 FILA



Nº CONTADORES	FILAS	REF.	EUROS	PESO UNID.
1	1	10011	18,30	1,000
2	1	10021	100,11	5,500
3	1	10031	121,06	7,000
4	1	10041	146,07	10,500
5	1	10051	162,40	11,500
6	1	10061	171,70	12,500

INCLUIDO KIT DE MONTAJE

### BATERÍAS VERSIÓN ACERO GALVANIZADO 2 FILAS



Nº CONTADORES	FILAS	REF.	EUROS	PESO UNID.
2	2	10022	101,47	5,000
4	2	10042	134,03	8,500
6	2	10062	173,24	10,000
8	2	10082	217,99	13,000
10	2	10102	248,55	14,500

INCLUIDO KIT DE MONTAJE

### BATERÍAS VERSIÓN ACERO GALVANIZADO HORIZONTAL



Nº CONTADORES	REF.	EUROS	PESO UNID.
2	12002	91,74	5,000
3	12003	109,04	6,000

INCLUIDO KIT DE MONTAJE

### BATERÍAS VERSIÓN ACERO GALVANIZADO HORIZONTAL CON CODO



Nº CONTADORES	REF.	EUROS	PESO UNID.
2	11002	101,11	5,500
3	11003	118,44	6,500

INCLUIDO KIT DE MONTAJE

Revisión A

### BATERÍAS POLIPROPILENO CIRCUITO CERRADO 2 FILAS

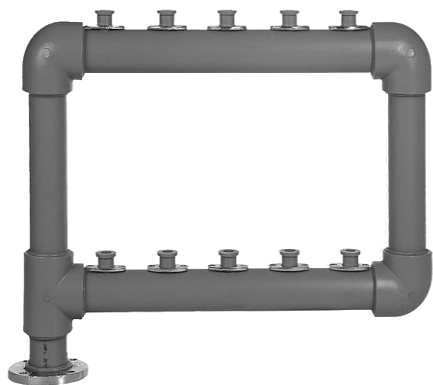

Nº CONTADORES	FILAS	Ø	PULGADAS	REF.	EUROS	PESO UNID.
4	2	63	2"	PPR71042	130,07	7,800
6	2	63	2"	PPR71062	140,08	8,600
8	2	75	2 1/2"	PPR71082	188,33	13,900
10	2	75	2 1/2"	PPR71102	199,67	14,900
12	2	75	2 1/2"	PPR71122	222,70	15,900
14	2	75	2 1/2"	PPR71142	242,59	16,900
16	2	75	2 1/2"	PPR71162	248,36	18,300
18	2	75	2 1/2"	PPR71182	267,16	18,900
20	2	75	2 1/2"	PPR71202	286,59	19,900
22	2	75	2 1/2"	PPR71222	306,01	20,900
24	2	75	2 1/2"	PPR71242	321,88	21,900
26	2	75	2 1/2"	PPR71262	334,73	22,900
28	2	75	2 1/2"	PPR71282	351,46	23,900
30	2	75	2 1/2"	PPR71302	371,43	24,900

INCLUIDO KIT DE MONTAJE

### BATERÍAS POLIPROPILENO CIRCUITO CERRADO 3 FILAS

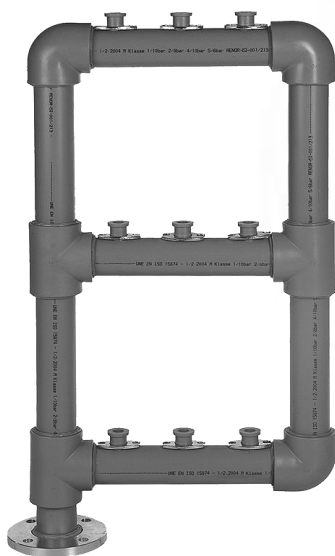

Nº CONTADORES	FILAS	Ø	PULGADAS	REF.	EUROS	PESO UNID.
6	3	63	2"	PPR72063	177,54	16,400
9	3	75	2 1/2"	PPR72093	250,72	17,600
12	3	75	2 1/2"	PPR72123	268,67	18,800
15	3	75	2 1/2"	PPR72153	288,13	20,000
18	3	75	2 1/2"	PPR72183	311,43	21,200
21	3	75	2 1/2"	PPR72213	336,42	22,400
24	3	75	2 1/2"	PPR72243	360,36	23,600
27	3	75	2 1/2"	PPR72273	381,06	24,800
30	3	75	2 1/2"	PPR72303	403,95	25,000
33	3	90	3"	PPR72333	555,08	28,100
36	3	90	3"	PPR72363	577,10	29,000
39	3	90	3"	PPR72393	599,12	29,900
42	3	90	3"	PPR72423	621,14	30,800
45	3	90	3"	PPR72453	643,16	31,700

INCLUIDO KIT DE MONTAJE

Revisión A

**BATERÍAS POLIPROPILENO  
MODELO CIRCUITO CERRADO 2 FILAS SUPERIOR**

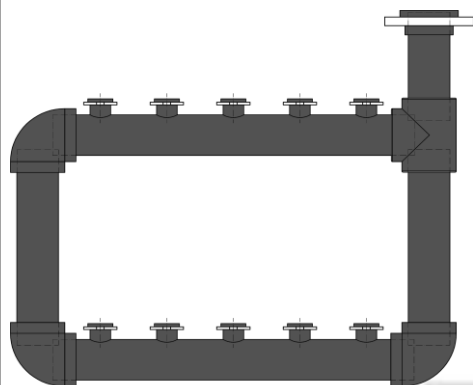

Nº CONTADORES	FILAS	Ø	PULGADAS	REF.	EUROS	PESO UNID.
4	2	63	2"	PPR71042S	139,72	7,800
6	2	63	2"	PPR71062S	149,41	8,600
8	2	75	2 1/2"	PPR71082S	211,86	13,900
10	2	75	2 1/2"	PPR71102S	224,66	14,900
12	2	75	2 1/2"	PPR71122S	244,45	15,900
14	2	75	2 1/2"	PPR71142S	266,27	16,900
16	2	75	2 1/2"	PPR71162S	274,79	18,300
18	2	75	2 1/2"	PPR71182S	295,65	18,900
20	2	75	2 1/2"	PPR71202S	309,53	19,900
22	2	75	2 1/2"	PPR71222S	330,58	20,900
24	2	75	2 1/2"	PPR71242S	347,65	21,900
26	2	75	2 1/2"	PPR71262S	361,70	22,900
28	2	75	2 1/2"	PPR71282S	379,59	23,900
30	2	75	2 1/2"	PPR71302S	401,18	24,900

INCLUIDO KIT DE MONTAJE

**BATERÍAS POLIPROPILENO  
MODELO CIRCUITO CERRADO 3 FILAS SUPERIOR**

Revisión A

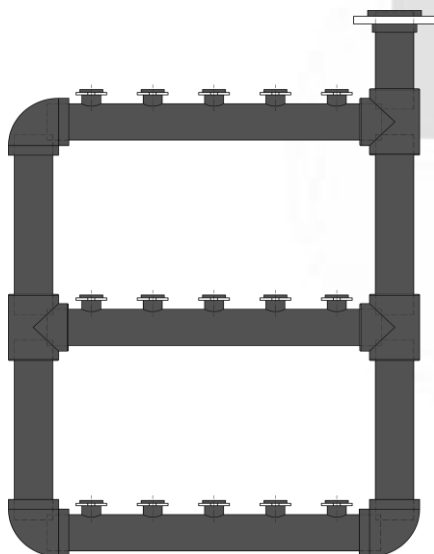

Nº CONTADORES	FILAS	Ø	PULGADAS	REF.	EUROS	PESO UNID.
6	3	63	2"	PPR72063S	194,55	16,400
9	3	75	2 1/2"	PPR72093S	270,92	17,600
12	3	75	2 1/2"	PPR72123S	290,23	18,800
15	3	75	2 1/2"	PPR72153S	313,81	20,000
18	3	75	2 1/2"	PPR72183S	336,35	21,200
21	3	75	2 1/2"	PPR72213S	363,42	22,400
24	3	75	2 1/2"	PPR72243S	391,58	23,600
27	3	75	2 1/2"	PPR72273S	411,92	24,800
30	3	75	2 1/2"	PPR72303S	432,35	25,000
33	3	90	3"	PPR72333S	611,82	28,100
36	3	90	3"	PPR72363S	635,97	29,000
39	3	90	3"	PPR72393S	660,18	29,900
42	3	90	3"	PPR72423S	684,55	30,800
45	3	90	3"	PPR72453S	708,82	31,700

INCLUIDO KIT DE MONTAJE

**BATERÍAS POLIPROPILENO  
MODELO CIRCUITO CERRADO 2 FILAS LATERAL INFERIOR Y SUPERIOR**



N° CONTADORES	FILAS	Ø	PULGADAS	REF. INFERIOR	EUROS	REF. SUPERIOR	EUROS	PESO UNID.
4	2	63	2"	PPR71042LI	164,98	PPR71042LS	164,98	7,800
6	2	63	2"	PPR71062LI	176,33	PPR71062LS	176,33	8,600
8	2	75	2 1/2"	PPR71082LI	243,12	PPR71082LS	243,12	13,900
10	2	75	2 1/2"	PPR71102LI	256,73	PPR71102LS	256,73	14,900
12	2	75	2 1/2"	PPR71122LI	270,36	PPR71122LS	270,36	15,900
14	2	75	2 1/2"	PPR71142LI	285,96	PPR71142LS	285,96	16,900
16	2	75	2 1/2"	PPR71162LI	299,59	PPR71162LS	299,59	18,300
18	2	75	2 1/2"	PPR71182LI	313,24	PPR71182LS	313,24	18,900
20	2	75	2 1/2"	PPR71202LI	326,87	PPR71202LS	326,87	19,900
22	2	75	2 1/2"	PPR71222LI	340,48	PPR71222LS	340,48	20,900
24	2	75	2 1/2"	PPR71242LI	354,12	PPR71242LS	354,12	21,900
26	2	75	2 1/2"	PPR71262LI	367,76	PPR71262LS	367,76	22,900
28	2	75	2 1/2"	PPR71282LI	389,59	PPR71282LS	389,59	23,900
30	2	75	2 1/2"	PPR71302LI	403,27	PPR71302LS	403,27	24,900

INCLUIDO KIT DE MONTAJE

**BATERÍAS POLIPROPILENO  
MODELO CIRCUITO CERRADO 3 FILAS LATERAL INFERIOR Y SUPERIOR**



N° CONTADORES	FILAS	Ø	PULGADAS	REF. INFERIOR	EUROS	REF. SUPERIOR	EUROS	PESO UNID.
6	3	63	2"	PPR72063LI	224,44	PPR72063LS	224,44	16,400
9	3	75	2 1/2"	PPR72093LI	302,29	PPR72093LS	302,29	17,600
12	3	75	2 1/2"	PPR72123LI	322,70	PPR72123LS	322,70	18,800
15	3	75	2 1/2"	PPR72153LI	343,18	PPR72153LS	343,18	20,000
18	3	75	2 1/2"	PPR72183LI	367,73	PPR72183LS	367,73	21,200
21	3	75	2 1/2"	PPR72213LI	388,15	PPR72213LS	388,15	22,400
24	3	75	2 1/2"	PPR72243LI	408,63	PPR72243LS	408,63	23,600
27	3	75	2 1/2"	PPR72273LI	429,08	PPR72273LS	429,08	24,800
30	3	75	2 1/2"	PPR72303LI	449,47	PPR72303LS	449,47	25,000
33	3	90	3"	PPR72333LI	648,70	PPR72333LS	648,70	28,100
36	3	90	3"	PPR72363LI	673,84	PPR72363LS	673,84	29,000
39	3	90	3"	PPR72393LI	698,91	PPR72393LS	698,91	29,900
42	3	90	3"	PPR72423LI	723,98	PPR72423LS	723,98	30,800
45	3	90	3"	PPR72453LI	749,02	PPR72453LS	749,02	31,700

INCLUIDO KIT DE MONTAJE

Revisión A

**BATERÍAS POLIPROPILENO  
MODELO CIRCUITO CERRADO 2 FILAS CENTRAL Y CENTRAL SUPERIOR ACODADA Y/O ACODADA**

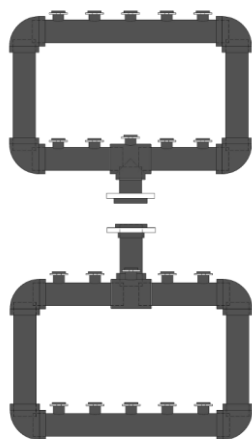

N° CONTADORES	FILAS	Ø	PULGADAS	REF. CENTRAL	EUROS	REF. CENTRAL SUPERIOR	EUROS	PESO UNID.
4	2	63	2"	PPR71042C	177,87	PPR71042CS	198,66	7,800
6	2	63	2"	PPR71062C	189,97	PPR71062CSA	229,28	8,600
8	2	75	2 1/2"	PPR71082C	269,54	PPR71082CS	272,05	13,900
10	2	75	2 1/2"	PPR71102C	284,02	PPR71102CSA	303,48	14,900
12	2	75	2 1/2"	PPR71122C	298,49	PPR71122CS	307,16	15,900
14	2	75	2 1/2"	PPR71142C	315,03	PPR71142CSA	334,52	16,900
16	2	75	2 1/2"	PPR71162C	329,54	PPR71162CS	338,19	18,300
18	2	75	2 1/2"	PPR71182C	344,03	PPR71182CSA	363,47	18,900
20	2	75	2 1/2"	PPR71202C	358,51	PPR71202CS	359,80	19,900
22	2	75	2 1/2"	PPR71222C	377,33	PPR71222CSA	389,41	20,900
24	2	75	2 1/2"	PPR71242C	391,80	PPR71242CS	398,93	21,900
26	2	75	2 1/2"	PPR71262C	406,29	PPR71262CSA	424,25	22,900
28	2	75	2 1/2"	PPR71282C	425,16	PPR71282CS	433,18	23,900
30	2	75	2 1/2"	PPR71302C	439,63	PPR71302CSA	458,49	24,900

INCLUIDO KIT DE MONTAJE

**BATERÍAS POLIPROPILENO  
MODELO CIRCUITO CERRADO 3 FILAS CENTRAL Y CENTRAL SUPERIOR ACODADA Y/O ACODADA**

Revisión A

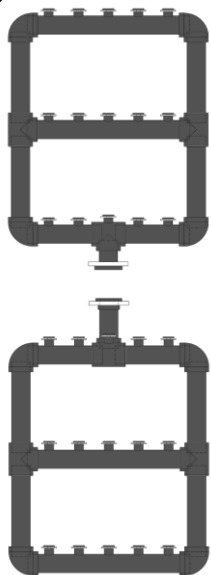

N° CONTADORES	FILAS	Ø	PULGADAS	REF. CENTRAL	EUROS	REF. CENTRAL SUPERIOR	EUROS	PESO UNID.
6	3	63	2"	PPR72063C	245,99	PPR72063CS	254,98	16,400
9	3	75	2 1/2"	PPR72093C	332,37	PPR72093CSA	351,86	17,600
12	3	75	2 1/2"	PPR72123C	354,09	PPR72123CS	356,62	18,800
15	3	75	2 1/2"	PPR72153C	375,82	PPR72153CSA	389,12	20,000
18	3	75	2 1/2"	PPR72183C	401,89	PPR72183CS	414,26	21,200
21	3	75	2 1/2"	PPR72213C	423,64	PPR72213CSA	443,08	22,400
24	3	75	2 1/2"	PPR72243C	445,32	PPR72243CS	457,68	23,600
27	3	75	2 1/2"	PPR72273C	467,07	PPR72273CSA	486,53	24,800
30	3	75	2 1/2"	PPR72303C	488,80	PPR72303CS	498,65	25,000
33	3	90	3"	PPR72333C	675,42	PPR72333CSA	714,55	28,100
36	3	90	3"	PPR72363C	700,51	PPR72363CS	708,68	29,000
39	3	90	3"	PPR72393C	725,55	PPR72393CSA	764,68	29,900
42	3	90	3"	PPR72423C	750,64	PPR72423CS	758,82	30,800
45	3	90	3"	PPR72453C	775,65	PPR72453CSA	814,80	31,700

INCLUIDO KIT DE MONTAJE

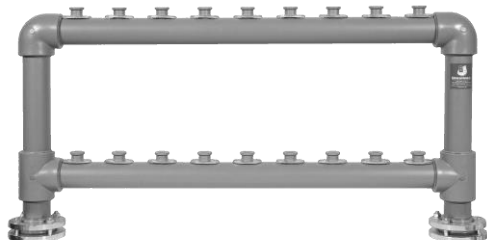
**BATERÍAS POLIPROPILENO**
**MODELO CIRCUITO CERRADO 2 FILAS CON DOBLE ALIMENTACIÓN**

N° CONTADORES	FILAS	Ø	PULGADAS	REF.	EUROS	PESO UNID.
18	2	75	2 1/2"	PPR91182	297,26	18,400
20	2	75	2 1/2"	PPR91202	309,23	19,300
22	2	75	2 1/2"	PPR91222	328,43	20,200
24	2	75	2 1/2"	PPR91242	340,40	21,100
26	2	75	2 1/2"	PPR91262	352,37	22,000
28	2	75	2 1/2"	PPR91282	364,34	22,900
30	2	75	2 1/2"	PPR91302	378,03	23,800

INCLUIDO KIT DE MONTAJE

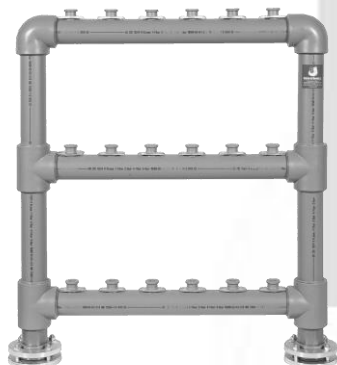
**BATERÍAS POLIPROPILENO**
**MODELO CIRCUITO CERRADO 3 FILAS CON DOBLE ALIMENTACIÓN**

N° CONTADORES	FILAS	Ø	PULGADAS	REF.	EUROS	PESO UNID.
18	3	75	2 1/2"	PPR92183	346,34	21,400
21	3	75	2 1/2"	PPR92213	364,30	22,300
24	3	75	2 1/2"	PPR92243	382,25	23,200
27	3	75	2 1/2"	PPR92273	400,21	24,100
30	3	75	2 1/2"	PPR92303	418,16	25,000
33	3	90	3"	PPR92333	613,98	27,900
36	3	90	3"	PPR92363	637,11	28,800
39	3	90	3"	PPR92393	661,95	29,700
42	3	90	3"	PPR92423	682,87	30,600
45	3	90	3"	PPR92453	708,19	31,500

INCLUIDO KIT DE MONTAJE

Revisión A

### BATERÍAS VERSIÓN POLIPROPILENO 1 FILA



Nº CONTADORES	FILAS	REF.	EUROS	PESO UNID.
1	1	PPR10011	14,80	3,000
2	1	PPR10021	77,34	3,800
3	1	PPR10031	86,80	4,500
4	1	PPR10041	97,12	5,300
5	1	PPR10051	107,87	6,000
6	1	PPR10061	124,29	6,800

INCLUIDO KIT DE MONTAJE

### BATERÍAS VERSIÓN POLIPROPILENO 2 FILAS



Nº CONTADORES	FILAS	REF.	EUROS	PESO UNID.
2	2	PPR10022	79,76	3,500
4	2	PPR10042	95,16	4,200
6	2	PPR10062	111,84	5,000
8	2	PPR10082	140,45	7,500
10	2	PPR10102	156,44	8,500
12	2	PPR10122	173,12	9,500

INCLUIDO KIT DE MONTAJE

Revisión A



**BATERÍAS POLIPROPILENO CIRCUITO CERRADO SERIE ROSCADA 2 FILAS**

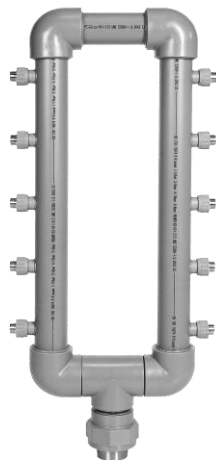

Nº CONTADORES	FILAS	Ø	R. ENTRADA	R. SALIDA	REF.	EUROS	PESO UNID.
6	2	63	2" H	3/4" M	PPR74062	188,43	3,900
8	2	63	2" H	3/4" M	PPR74082	207,66	4,800
10	2	75	2 1/2" H	3/4" M	PPR74102	276,91	9,000
12	2	75	2 1/2" H	3/4" M	PPR74122	298,65	9,800
14	2	75	2 1/2" H	3/4" M	PPR74142	320,38	10,600
16	2	75	2 1/2" H	3/4" M	PPR74162	343,04	11,400
18	2	75	2 1/2" H	3/4" M	PPR74182	364,78	12,200
20	2	75	2 1/2" H	3/4" M	PPR74202	386,51	13,000
22	2	75	2 1/2" H	3/4" M	PPR74222	409,17	13,800
24	2	75	2 1/2" H	3/4" M	PPR74242	432,68	14,600
26	2	75	2 1/2" H	3/4" M	PPR74262	454,41	15,400
28	2	75	2 1/2" H	3/4" M	PPR74282	477,07	16,200
30	2	75	2 1/2" H	3/4" M	PPR74302	506,22	17,000

INCLUIDO SOPORTE SUJECCIÓN

**BATERÍAS VERSIÓN POLIPROPILENO ROSCADA 1 FILA**



Nº CONTADORES	FILAS	Ø	R. ENTRADA	R. SALIDA	REF.	EUROS	PESO UNID.
3	1	63	2" H	3/4" M	PPR61031	86,82	1,800
4	1	63	2" H	3/4" M	PPR61041	94,72	2,200
5	1	63	2" H	3/4" M	PPR61051	102,76	3,000
6	1	63	2" H	3/4" M	PPR61061	112,37	3,900
7	1	63	2" H	3/4" M	PPR61071	120,13	4,300
8	1	75	2 1/2" H	3/4" M	PPR61081	159,43	5,100
9	1	75	2 1/2" H	3/4" M	PPR61091	167,98	6,700
10	1	75	2 1/2" H	3/4" M	PPR61101	177,46	7,500

PARA BATERÍAS CON OTRAS MEDIDAS CONSULTAR

**BATERÍAS VERSIÓN POLIPROPILENO ROSCADA 2 FILAS**



Nº CONTADORES	FILAS	Ø	R. ENTRADA	R. SALIDA	REF.	EUROS	PESO UNID.
4	2	63	2" H	3/4" M	PPR61042	93,02	2,600
6	2	63	2" H	3/4" M	PPR61062	105,66	3,400
8	2	75	2 1/2" H	3/4" M	PPR61082	146,15	5,900
10	2	75	2 1/2" H	3/4" M	PPR61102	161,79	8,300
12	2	75	2 1/2" H	3/4" M	PPR61122	177,49	9,100
14	2	75	2 1/2" H	3/4" M	PPR61142	190,54	9,900
16	2	75	2 1/2" H	3/4" M	PPR61162	202,18	10,700
18	2	75	2 1/2" H	3/4" M	PPR61182	215,60	11,500
20	2	75	2 1/2" H	3/4" M	PPR61202	229,50	12,300

PARA BATERÍAS CON OTRAS MEDIDAS CONSULTAR

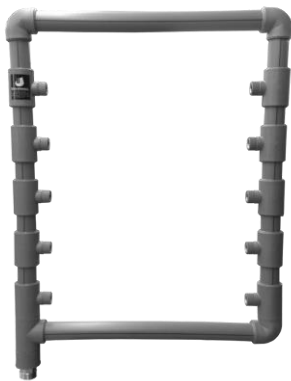
**BATERÍAS POLIPROPILENO CIRCUITO CERRADO 2 FILAS SERIE ROSCADA**

Nº CONTADORES	FILAS	Ø	R.ENTRADA	R.SALIDA	REF.	EUROS	PESO UNID.
6	2	63	2" M	3/4" H	PPRE75062E	373,45	10,000
8	2	63	2" M	3/4" H	PPRE75082E	440,72	12,000
10	2	63	2" M	3/4" H	PPRE75102E	476,47	14,000
12	2	63	2" M	3/4" H	PPRE75122E	509,06	16,000
14	2	63	2" M	3/4" H	PPRE75142E	556,04	18,000
16	2	63	2" M	3/4" H	PPRE75162E	600,00	20,000

SOPORTES NO INCLUIDOS

Revisión A



### BATERÍAS POLIPROPILENO 2 FILAS SERIE ROSCADA



Nº CONTADORES	FILAS	Ø	R.ENTRADA	R.SALIDA	REF.	EUROS	PESO UNID.
2	2	50	1 1/2" M	3/4" H	PPRE74022	198,14	9,000
4	2	50	1 1/2" M	3/4" H	PPRE74042	244,14	10,500
6	2	50	1 1/2" M	3/4" H	PPRE74062	277,78	12,000

SOPORTES NO INCLUIDOS

### BATERÍAS POLIPROPILENO VERSIÓN 1 FILA SERIE ROSCADA



Nº CONTADORES	FILAS	Ø	R.ENTRADA	R.SALIDA	REF.	EUROS	PESO UNID.
2	1	40	1" M	3/4" H	PPRE63021	114,94	3,000
3	1	40	1" M	3/4" H	PPRE63031	134,68	4,000
4	1	40	1" M	3/4" H	PPRE63041	154,84	5,000

SOPORTES NO INCLUIDOS

Revisión A

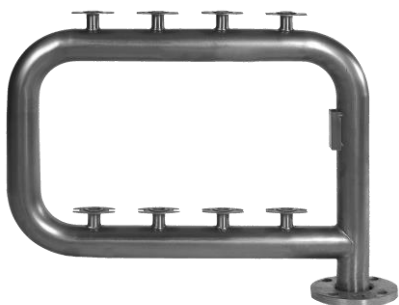
**BATERÍAS ACERO INOXIDABLE  
 MODELO CUADRO CIRCUITO CERRADO 2 FILAS**

N° CONTADORES	Ø	FILAS	PULGADAS	REF.	EUROS	PESO UNID.
4	63	2	2"	INOX20042	287,97	4,700
6	63	2	2"	INOX20062	316,92	5,200
8	63	2	2 1/2"	INOX20082	359,23	5,900
10	63	2	2 1/2"	INOX20102	400,74	6,700
12	63	2	2 1/2"	INOX20122	433,25	7,700
14	63	2	2 1/2"	INOX20142	465,79	8,100
16	63	2	2 1/2"	INOX20162	498,34	9,200
18	63	2	2 1/2"	INOX20182	515,91	9,700
20	63	2	2 1/2"	INOX20202	563,44	10,800
22	63	2	2 1/2"	INOX20222	595,99	11,500
24	63	2	2 1/2"	INOX20242	630,41	12,000
26	63	2	2 1/2"	INOX20262	662,96	12,700
28	63	2	2 1/2"	INOX20282	695,51	13,800
30	63	2	2 1/2"	INOX20302	728,06	14,300

INCLUIDO KIT DE MONTAJE

Revisión A

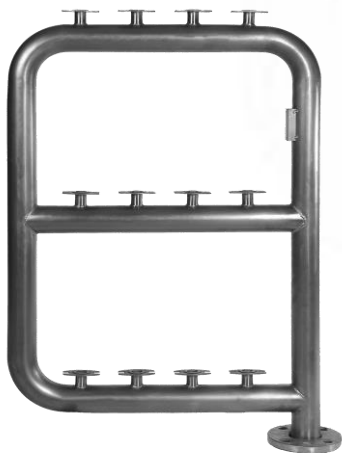
**BATERÍAS ACERO INOXIDABLE  
 MODELO CUADRO CIRCUITO CERRADO 3 FILAS**

N° CONTADORES	Ø	FILAS	PULGADAS	REF.	EUROS	PESO UNID.
6	63	3	2"	INOX30063	420,60	7,500
9	63	3	2 1/2"	INOX30093	465,07	8,200
12	63	3	2 1/2"	INOX30123	509,53	9,500
15	63	3	2 1/2"	INOX30153	554,13	10,500
18	63	3	2 1/2"	INOX30183	601,38	11,500
21	63	3	2 1/2"	INOX30213	647,27	12,800
24	63	3	2 1/2"	INOX30243	692,41	13,900
27	63	3	2 1/2"	INOX30273	737,45	15,000
30	63	3	2 1/2"	INOX30303	783,73	16,100
33	75	3	2 1/2"	INOX30333	983,14	21,300
36	75	3	2 1/2"	INOX30363	1.039,17	23,200
39	75	3	2 1/2"	INOX30393	1.118,76	25,100
42	75	3	2 1/2"	INOX30423	1.174,78	27,000
45	75	3	2 1/2"	INOX30453	1.254,38	28,800

OPCIONAL: En baterías con tubo Ø75 se pueden suministrar con brida roscada de 3"

INCLUIDO KIT DE MONTAJE

**BATERÍAS ACERO INOXIDABLE  
MODELO CIRCUITO CERRADO 2 FILAS SUPERIOR**



Nº CONTADORES	FILAS	Ø	PULGADAS	REF.	EUROS	PESO UNID.
4	2	63	2"	INOX20042S	311,45	4,700
6	2	63	2"	INOX20062S	342,78	5,200
8	2	63	2 1/2"	INOX20082S	388,51	5,900
10	2	63	2 1/2"	INOX20102S	433,07	6,700
12	2	63	2 1/2"	INOX20122S	468,34	7,700
14	2	63	2 1/2"	INOX20142S	503,48	8,100
16	2	63	2 1/2"	INOX20162S	538,62	9,200
18	2	63	2 1/2"	INOX20182S	557,68	9,700
20	2	63	2 1/2"	INOX20202S	609,00	10,800
22	2	63	2 1/2"	INOX20222S	644,25	11,500
24	2	63	2 1/2"	INOX20242S	681,30	12,000
26	2	63	2 1/2"	INOX20262S	716,58	12,700
28	2	63	2 1/2"	INOX20282S	751,77	13,800
30	2	63	2 1/2"	INOX20302S	787,00	14,300

INCLUIDO KIT DE MONTAJE

**BATERÍAS ACERO INOXIDABLE  
MODELO CIRCUITO CERRADO 3 FILAS SUPERIOR**



Nº CONTADORES	FILAS	Ø	PULGADAS	REF.	EUROS	PESO UNID.
6	3	63	2"	INOX30063S	454,65	7,500
9	3	63	2 1/2"	INOX30093S	502,70	8,200
12	3	63	2 1/2"	INOX30123S	550,80	9,500
15	3	63	2 1/2"	INOX30153S	598,98	10,500
18	3	63	2 1/2"	INOX30183S	650,04	11,500
21	3	63	2 1/2"	INOX30213S	699,54	12,800
24	3	63	2 1/2"	INOX30243S	748,48	13,900
27	3	63	2 1/2"	INOX30273S	797,11	15,000
30	3	63	2 1/2"	INOX30303S	847,20	16,100
33	3	75	2 1/2"	INOX30333S	1.062,54	21,300
36	3	75	2 1/2"	INOX30363S	1.123,35	23,200
39	3	75	2 1/2"	INOX30393S	1.209,22	25,100
42	3	75	2 1/2"	INOX30423S	1.269,69	27,000
45	3	75	2 1/2"	INOX30453S	1.355,84	28,800

OPCIONAL: En baterías con tubo Ø75 se pueden suministrar con brida roscada de 3"

INCLUIDO KIT DE MONTAJE

Revisión A

**BATERÍAS ACERO INOXIDABLE  
MODELO CIRCUITO CERRADO 2 FILAS LATERAL INFERIOR Y SUPERIOR**



N° CONTADORES	FILAS	Ø	PULGADAS	REF. INFERIOR	EUROS	REF. SUPERIOR	EUROS	PESO UNID.
4	2	63	2"	INOX20042LI	326,62	INOX20042LS	326,62	4,700
6	2	63	2"	INOX20062LI	357,95	INOX20062LS	357,95	5,200
8	2	63	2 1/2"	INOX20082LI	403,68	INOX20082LS	403,68	5,900
10	2	63	2 1/2"	INOX20102LI	438,05	INOX20102LS	438,05	6,700
12	2	63	2 1/2"	INOX20122LI	472,35	INOX20122LS	472,35	7,700
14	2	63	2 1/2"	INOX20142LI	506,67	INOX20142LS	506,67	8,100
16	2	63	2 1/2"	INOX20162LI	540,99	INOX20162LS	540,99	9,200
18	2	63	2 1/2"	INOX20182LI	577,00	INOX20182LS	577,00	9,700
20	2	63	2 1/2"	INOX20202LI	628,75	INOX20202LS	628,75	10,800
22	2	63	2 1/2"	INOX20222LI	664,14	INOX20222LS	664,14	11,500
24	2	63	2 1/2"	INOX20242LI	701,61	INOX20242LS	701,61	12,000
26	2	63	2 1/2"	INOX20262LI	737,05	INOX20262LS	737,05	12,700
28	2	63	2 1/2"	INOX20282LI	772,48	INOX20282LS	772,48	13,800
30	2	63	2 1/2"	INOX20302LI	807,90	INOX20302LS	807,90	14,300

INCLUIDO KIT DE MONTAJE

**BATERÍAS ACERO INOXIDABLE  
MODELO CIRCUITO CERRADO 3 FILAS LATERAL INFERIOR Y SUPERIOR**



N° CONTADORES	FILAS	Ø	PULGADAS	REF. INFERIOR	EUROS	REF. SUPERIOR	EUROS	PESO UNID.
6	3	63	2"	INOX30063LI	473,32	INOX30063LS	473,32	7,500
9	3	63	2 1/2"	INOX30093LI	521,69	INOX30093LS	521,69	8,200
12	3	63	2 1/2"	INOX30123LI	570,08	INOX30123LS	570,08	9,500
15	3	63	2 1/2"	INOX30153LI	618,61	INOX30153LS	618,61	10,500
18	3	63	2 1/2"	INOX30183LI	670,05	INOX30183LS	670,05	11,500
21	3	63	2 1/2"	INOX30213LI	720,00	INOX30213LS	720,00	12,800
24	3	63	2 1/2"	INOX30243LI	769,15	INOX30243LS	769,15	13,900
27	3	63	2 1/2"	INOX30273LI	818,11	INOX30273LS	818,11	15,000
30	3	63	2 1/2"	INOX30303LI	868,42	INOX30303LS	868,42	16,100
33	3	75	2 1/2"	INOX30333LI	1.059,85	INOX30333LS	1.059,85	21,300
36	3	75	2 1/2"	INOX30363LI	1.119,50	INOX30363LS	1.119,50	23,200
39	3	75	2 1/2"	INOX30393LI	1.203,90	INOX30393LS	1.203,90	25,100
42	3	75	2 1/2"	INOX30423LI	1.263,42	INOX30423LS	1.263,42	27,000
45	3	75	2 1/2"	INOX30453LI	1.348,05	INOX30453LS	1.348,05	28,800

OPCIONAL: En baterías con tubo Ø75 se pueden suministrar con brida roscada de 3"

INCLUIDO KIT DE MONTAJE

Revisión A

**BATERÍAS ACERO INOXIDABLE**  
**MODELO CIRCUITO CERRADO 2 FILAS CENTRAL Y CENTRAL SUPERIOR Y/O ACODADA**



N° CONTADORES	FILAS	Ø	PULGADAS	REF. CENTRAL	EUROS	REF. CENTRAL SUPERIOR	EUROS	PESO UNID.
4	2	63	2"	INOX20042C	352,77	INOX20042CS	370,25	4,700
6	2	63	2"	INOX20062C	386,04	INOX20062CSA	422,54	5,200
8	2	63	2 1/2"	INOX20082C	434,65	INOX20082CS	452,15	5,900
10	2	63	2 1/2"	INOX20102C	471,18	INOX20102CSA	517,98	6,700
12	2	63	2 1/2"	INOX20122C	507,60	INOX20122CS	525,61	7,700
14	2	63	2 1/2"	INOX20142C	544,11	INOX20142CSA	593,50	8,100
16	2	63	2 1/2"	INOX20162C	580,55	INOX20162CS	598,11	9,200
18	2	63	2 1/2"	INOX20182C	600,27	INOX20182CSA	641,90	9,700
20	2	63	2 1/2"	INOX20202C	653,59	INOX20202CS	671,00	10,800
22	2	63	2 1/2"	INOX20222C	690,00	INOX20222CSA	736,80	11,500
24	2	63	2 1/2"	INOX20242C	728,68	INOX20242CS	746,14	12,000
26	2	63	2 1/2"	INOX20262C	765,10	INOX20262CSA	811,90	12,700
28	2	63	2 1/2"	INOX20282C	801,57	INOX20282CS	819,08	13,800
30	2	63	2 1/2"	INOX20302C	838,14	INOX20302CSA	884,92	14,300

INCLUIDO KIT DE MONTAJE

**BATERÍAS ACERO INOXIDABLE**  
**MODELO CIRCUITO CERRADO 3 FILAS CENTRAL Y CENTRAL SUPERIOR Y/O ACODADA**



N° CONTADORES	FILAS	Ø	PULGADAS	REF. CENTRAL	EUROS	REF. CENTRAL SUPERIOR	EUROS	PESO UNID.
6	3	63	2"	INOX30063C	493,42	INOX30063CS	510,89	7,500
9	3	63	2 1/2"	INOX30093C	543,30	INOX30093CSA	590,05	8,200
12	3	63	2 1/2"	INOX30123C	599,60	INOX30123CS	617,08	9,500
15	3	63	2 1/2"	INOX30153C	643,12	INOX30153CSA	689,88	10,500
18	3	63	2 1/2"	INOX30183C	696,05	INOX30183CS	713,58	11,500
21	3	63	2 1/2"	INOX30213C	747,49	INOX30213CSA	794,34	12,800
24	3	63	2 1/2"	INOX30243C	798,10	INOX30243CS	815,57	13,900
27	3	63	2 1/2"	INOX30273C	848,66	INOX30273CSA	895,45	15,000
30	3	63	2 1/2"	INOX30303C	900,50	INOX30303CS	918,05	16,100
33	3	75	2 1/2"	INOX30333C	1.097,72	INOX30333CSA	1.153,15	21,300
36	3	75	2 1/2"	INOX30363C	1.158,98	INOX30363CS	1.177,23	23,200
39	3	75	2 1/2"	INOX30393C	1.246,12	INOX30393CSA	1.301,55	25,100
42	3	75	2 1/2"	INOX30423C	1.313,84	INOX30423CS	1.332,00	27,000
45	3	75	2 1/2"	INOX30453C	1.394,60	INOX30453CSA	1.400,90	28,800

OPCIONAL: En baterías con tubo Ø75 se pueden suministrar con brida roscada de 3"

INCLUIDO KIT DE MONTAJE

Revisión A

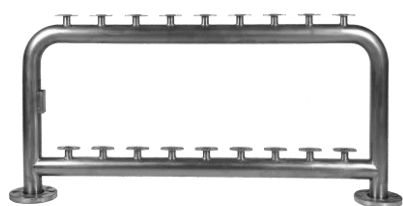
**BATERÍAS ACERO INOXIDABLE  
 MODELO CUADRO CIRCUITO CERRADO 2 FILAS CON DOBLE ALIMENTACIÓN**

Nº CONTADORES	Ø	FILAS	PULGADAS	REF.	EUROS	PESO UNID.
18	63	2	2 1/2"	INOX40182	581,88	10,500
20	63	2	2 1/2"	INOX40202	614,49	11,200
22	63	2	2 1/2"	INOX40222	646,98	11,900
24	63	2	2 1/2"	INOX40242	679,42	12,700
26	63	2	2 1/2"	INOX40262	711,92	13,400
28	63	2	2 1/2"	INOX40282	744,36	14,100
30	63	2	2 1/2"	INOX40302	776,91	14,800

INCLUIDO KIT DE MONTAJE

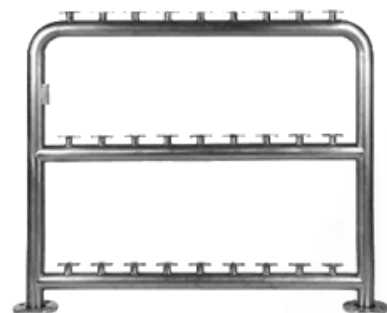
**BATERÍAS ACERO INOXIDABLE  
 MODELO CUADRO CIRCUITO CERRADO 3 FILAS CON DOBLE ALIMENTACIÓN**

Nº CONTADORES	Ø	FILAS	PULGADAS	REF.	EUROS	PESO UNID.
18	63	3	2 1/2"	INOX50183	673,68	12,900
21	63	3	2 1/2"	INOX50213	717,77	13,900
24	63	3	2 1/2"	INOX50243	762,98	14,920
27	63	3	2 1/2"	INOX50273	824,30	15,930
30	63	3	2 1/2"	INOX50303	874,77	16,940
33	75	3	2 1/2"	INOX50333	1.015,81	22,100
36	75	3	2 1/2"	INOX50363	1.071,89	23,900
39	75	3	2 1/2"	INOX50393	1.151,48	25,700
42	75	3	2 1/2"	INOX50423	1.207,56	26,900
45	75	3	2 1/2"	INOX50453	1.288,26	28,400

OPCIONAL: En baterías con tubo Ø75 se pueden suministrar con brida roscada de 3"

INCLUIDO KIT DE MONTAJE

Revisión A



**BATERÍAS VERSIÓN ACERO INOXIDABLE 1 FILA**

Nº CONTADORES	FILAS	REF.	EUROS	PESO UNID.
1	1	INOX10011	37,25	0,350
2	1	INOX10021	147,62	1,300
3	1	INOX10031	177,74	1,750
4	1	INOX10041	207,30	2,200
5	1	INOX10051	244,55	2,650

INCLUIDO KIT DE MONTAJE

**BATERÍAS VERSIÓN ACERO INOXIDABLE 2 FILAS**

Nº CONTADORES	FILAS	REF.	EUROS	PESO UNID.
2	2	INOX10022	159,00	0,900
4	2	INOX10042	201,99	1,750
6	2	INOX10062	250,48	2,600
8	2	INOX10082	314,07	4,450
10	2	INOX10102	394,03	4,750

INCLUIDO KIT DE MONTAJE

**BATERÍAS VERSIÓN ACERO INOXIDABLE HORIZONTAL**

Nº CONTADORES	REF.	EUROS	PESO UNID.
2	INOX12002	127,35	1,200
3	INOX12003	142,55	1,650

INCLUIDO KIT DE MONTAJE

**BATERÍAS VERSIÓN ACERO INOXIDABLE HORIZONTAL CON CODO**

Nº CONTADORES	REF.	EUROS	PESO UNID.
2	INOX11002	139,22	1,400
3	INOX11003	154,35	1,800

INCLUIDO KIT DE MONTAJE

Revisión A

**BATERÍAS POLIETILENO VERSIÓN**

**(COLECTOR DE UNA SOLA PIEZA)**



Nº CONTADORES	FILAS	Ø	R. ENTRADA	R. SALIDA	REF.	EUROS	PESO UNID.
3	1	63	2" M	3/4" M	PE61031	46,78	0,150
4	1	63	2" M	3/4" M	PE61041	51,73	0,182
5	1	63	2" M	3/4" M	PE61051	54,23	0,212
6	1	63	2" M	3/4" M	PE61061	57,74	0,244
7	1	63	2" M	3/4" M	PE61071	63,73	0,276
8	1	63	2" M	3/4" M	PE61081	67,59	0,308
9	1	63	2" M	3/4" M	PE61091	73,74	0,340
10	1	63	2" M	3/4" M	PE61101	77,42	0,372

PARA BATERÍAS CON OTRAS MEDIDAS CONSULTAR

**BATERÍAS POLIETILENO ROSCADAS MOD. TREVI**

**(TUBO VERTICAL Y SALIDAS DE UNA SOLA PIEZA)**



Nº CONTADORES	FILAS	Ø	R. ENTRADA	R. SALIDA	REF.	EUROS	PESO UNID.
6	2	63	2" M	3/4" M	PE74062	102,50	0,201
8	2	63	2" M	3/4" M	PE74082	117,41	0,224
10	2	63	2" M	3/4" M	PE74102	117,41	0,256
12	2	63	2" M	3/4" M	PE74122	124,42	0,288
14	2	63	2" M	3/4" M	PE74142	136,41	0,320
16	2	63	2" M	3/4" M	PE74162	151,97	0,352
18	2	63	2" M	3/4" M	PE74182	162,97	0,382

PARA BATERÍAS CON OTRAS MEDIDAS CONSULTAR

Revisión A

### AMPLIACIÓN DE BATERÍA



#### AMPLIACIÓN DE BATERÍA A/G

REF.	EUROS	UNID. DE EMBALAJE	PESO UNID.
1010001	49,96	1	1,000

#### AMPLIACIÓN DE BATERÍA PPR

REF.	EUROS	UNID. DE EMBALAJE	PESO UNID.
1010010	38,60	1	0,350

#### AMPLIACIÓN DE BATERÍA A/INOX

REF.	EUROS	UNID. DE EMBALAJE	PESO UNID.
1010020	86,27	1	0,450

### CAÑO LIBRE COMPROBACIÓN EN PPR



#### 3/4" x 3/4" PPR LONG. 110

REF.	EUROS	UNID. DE EMBALAJE	PESO UNID.
1010107	3,40	10	0,020

#### 7/8" x 3/4" PPR LONG. 115

REF.	EUROS	UNID. DE EMBALAJE	PESO UNID.
1010109	4,52	10	0,025

#### 1" x 1" PPR LONG. 130

REF.	EUROS	UNID. DE EMBALAJE	PESO UNID.
1010108	5,04	10	0,030

### CAÑO SUPLETORIO CIEGO



#### 3/4" x 3/4" LONG. 115 COLOR AZUL

REF.	EUROS	UNID. DE EMBALAJE	PESO UNID.
1010110	8,81	10	0,068

#### 1" x 1" LONG. 190 COLOR ROJO

REF.	EUROS	UNID. DE EMBALAJE	PESO UNID.
1010111	11,72	10	0,160

\* Hasta fin de existencias

Revisión A

**BRIDA CIEGA ZINCADA CON TORNILLOS Y JUNTA**

	REF.	EUROS	UNID. DE EMBALAJE	PESO UNID.
	1010201	4,10	10	0,216

**BRIDA CIEGA A/INOX CON TORNILLOS Y JUNTA**

	REF.	EUROS	UNID. DE EMBALAJE	PESO UNID.
	1010204	5,95	10	0,144

**BRIDA CIEGA ANTIFRAUDE**

**SISTEMA PATENTADO**

	REF.	EUROS	UNID. DE EMBALAJE	PESO UNID.
	1010209	21,76	10	0,526

TAPONES ANTIFRAUDE NO INCLUIDOS

**CONTRABRIDA MACHO CON TORNILLOS Y JUNTA**

	REF.	EUROS	UNID. DE EMBALAJE	PESO UNID.
	1010211	5,85	10	0,236

Revisión A

**ABRAZADERAS DE REPARACIÓN ACERO INOXIDABLE CON TOMA****ABRAZADERA DE REPARACIÓN ACERO INOX. Ø63 CON TOMA**

REF.	EUROS	UNID. DE EMBALAJE	PESO UNID.
380001	59,51	1	0,450

**ABRAZADERA DE REPARACIÓN ACERO INOX. Ø75 CON TOMA**

REF.	EUROS	UNID. DE EMBALAJE	PESO UNID.
380002	59,93	1	0,550

**ABRAZADERA DE REPARACIÓN ACERO INOX. Ø90 CON TOMA**

REF.	EUROS	UNID. DE EMBALAJE	PESO UNID.
380003	61,11	1	0,650

BS

Revisión A

**SOPORTE BATERÍA ACERO ZINCADO**
**SOPORTE BATERÍA A/G Ø10**

REF.	EUROS	UNID. DE EMBALAJE	PESO UNID.
1010011	1,83	2	0,150

**SOPORTE BATERÍA A/G Ø12**

REF.	EUROS	UNID. DE EMBALAJE	PESO UNID.
1010012	3,50	2	0,200

**SOPORTE BATERÍA ACERO ZINCADO**
**SOPORTE BATERÍA PPR-PE Ø DE TUBO 63**

REF.	EUROS	UNID. DE EMBALAJE	PESO UNID.
1010014	1,83	2	0,185

**SOPORTE BATERÍA PPR-PE Ø DE TUBO 75**

REF.	EUROS	UNID. DE EMBALAJE	PESO UNID.
1010015	3,52	2	0,210

**SOPORTE BATERÍA PPR-PE Ø DE TUBO 90**

REF.	EUROS	UNID. DE EMBALAJE	PESO UNID.
1010016	3,53	2	0,210

**SOPORTE BATERÍA A/INOX. AISI-304**
**SOPORTE BATERÍA A/INOX PARA Ø DE TUBO 63**

REF.	EUROS	UNID. DE EMBALAJE	PESO UNID.
1010017	7,59	2	0,140

**SOPORTE BATERÍA A/INOX PARA Ø DE TUBO 75**

REF.	EUROS	UNID. DE EMBALAJE	PESO UNID.
1010018	8,84	2	0,153

Revisión A

### PLACAS DE CLASIFICACIÓN



4x2 a 30x2	REF.	EUROS	6x3 a 60x3	REF.	EUROS	UNID.
4x2	01011042	5,99	6x3	01011063	6,98	1
6x2	01011062	6,73	9x3	01011093	7,94	1
8x2	01011082	7,49	12x3	01011123	8,90	1
10x2	01011102	8,24	15x3	01011153	9,86	1
12x2	01011122	8,98	18x3	01011183	10,81	1
14x2	01011142	9,74	21x3	01011213	12,83	1
16x2	01011162	10,49	24x3	01011243	13,72	1
18x2	01011182	11,23	27x3	01011273	14,68	1
20x2	01011202	12,24	30x3	01011303	16,13	1
22x2	01011222	12,99	33x3	01011333	17,99	1
24x2	01011242	13,74	36x3	01011363	19,32	1
26x2	01011262	14,99	39x3	01011393	20,32	1
28x2	01011282	15,74	42x3	01011423	21,96	1
30x2	01011302	16,68	45x3	01011453	23,68	1
			48x3	01011483	25,95	1
			51x3	01011513	28,14	1
			54x3	01011543	28,90	1
			57x3	01011573	31,18	1
			60x3	01011603	34,31	1

### CONEXIONES FLEXIBLES



MEDIDA	LONGITUD	ROSCA	MATERIAL	REF.	EUROS	UNID. EMBALAJE	PESO UNID.
3/4"	400	M-H	GALVANIZADO(*)	1010340	8,02	10	0,300
1"	300	M-H	GALVANIZADO(*)	1010430	11,71	10	0,300
1"	500	M-H	GALVANIZADO(*)	1010450	13,96	10	0,400
3/4"	300	M-H	INOXIDABLE	1010530	9,61	10	0,250
3/4"	400	M-H	INOXIDABLE	1010540	10,39	10	0,300
3/4"	500	M-H	INOXIDABLE	1010550	11,31	10	0,350
3/4"	600	M-H	INOXIDABLE	1010560	12,17	10	0,400
1"	300	M-H	INOXIDABLE	1010630	16,26	10	0,300
1"	400	M-H	INOXIDABLE	1010640	16,75	10	0,350
1"	500	M-H	INOXIDABLE	1010650	18,51	10	0,400
1"	600	M-H	INOXIDABLE	1010660	19,74	10	0,450

(\*) Hasta fin de existencias en conexiones flexibles en acero galvanizado.

**JUNTAS PLANAS EPDM PARA BRIDAS PN6 – PN10**

**JUNTA PLANA BRIDA PN 10 1 1/4" AG-INOX 80x44x3**

REF.	EUROS	UNID. DE EMBALAJE	PESO UNID.
1010940	0,65	5	0,018

**JUNTA PLANA BRIDA PN 10 1 1/2" AG-INOX 93x49x3**

REF.	EUROS	UNID. DE EMBALAJE	PESO UNID.
1010941	0,78	5	0,024

**JUNTA PLANA BRIDA PN 10 2" AG-INOX 104x65x3**

REF.	EUROS	UNID. DE EMBALAJE	PESO UNID.
1010942	0,89	5	0,031

**JUNTA PLANA BRIDA PN 10 2 1/2" AG-INOX 127x76x3**

REF.	EUROS	UNID. DE EMBALAJE	PESO UNID.
1010943	1,70	5	0,037

**JUNTA PLANA BRIDA PN 10 3" AG-INOX 143x90x3**

REF.	EUROS	UNID. DE EMBALAJE	PESO UNID.
1010944	1,80	5	0,043



**JUNTA PLANA BRIDA PN 6 2" PPR-PE 93x49x3**

REF.	EUROS	UNID. DE EMBALAJE	PESO UNID.
1010941	0,78	5	0,031

**JUNTA PLANA BRIDA PN 6 2 1/2" PPR-PE 104x65x3**

REF.	EUROS	UNID. DE EMBALAJE	PESO UNID.
1010942	0,89	5	0,037

**JUNTA PLANA BRIDA PN 6 3" PPR-PE 127x76x3**

REF.	EUROS	UNID. DE EMBALAJE	PESO UNID.
1010943	1,70	5	0,043



Revisión A





**JUNTA PLANA BRIDA CIEGA 44x3**

REF.	EUROS	UNID. DE EMBALAJE	PESO UNID.
1036001	0,38	5	0,006



**JUNTA PLANA CONTRABRIDA 43x20x3**

REF.	EUROS	UNID. DE EMBALAJE	PESO UNID.
1035110	0,50	5	0,009



**JUNTA PLANA 3/4" PARA CONEXIÓN FLEXIBLE**

REF.	EUROS	UNID. DE EMBALAJE	PESO UNID.
1035111	0,19	20	0,006

**JUNTA PLANA 1" PARA CONEXIÓN FLEXIBLE**

REF.	EUROS	UNID. DE EMBALAJE	PESO UNID.
1035161	0,27	20	0,006

Revisión A

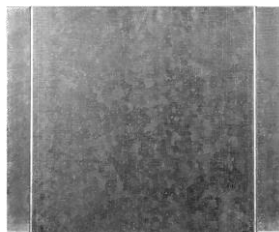
**BANCADAS PARA GRUPOS DE PRESIÓN**

MEDIDAS	REF.	EUROS	UNID. EMBALAJE	PESO UNID.
40x38	160001	37,63	1	5,100
70x38	160006	86,27	1	8,900
80x70	160011	122,69	1	11,700
80x38	160013	99,09	1	10,800
90x38	160007	106,15	1	12,900
90x50	160008	122,69	1	14,600
90x70	160012	139,19	1	17,300
95x65	160019	229,80	1	20,200

**COLECTOR SIN SALIDA DE MANÓMETRO ZINCADOS**

PULGADAS	REF.	EUROS	UNID. EMBALAJE	PESO UNID.
1 ½" 1 ¼"	161001	78,94	1	1,600
2" 1 ½"	161002	85,47	1	2,100
2 ½" 2"	161003	104,13	1	4,500
3" 2 ½"	161004	123,92	1	5,200

**COLECTOR CON SALIDA DE MANÓMETRO ZINCADOS**

PULGADAS	REF.	EUROS	UNID. EMBALAJE	PESO UNID.
1 ½" 1 ¼"	162001	79,16	1	1,650
2" 1 ½"	162002	86,88	1	2,500
2 ½" 2"	162003	105,40	1	4,800
3" 2 ½"	162004	125,60	1	5,450

**COLECTOR 3 VÍAS PARA BATERÍA DE CONTADORES**

BRIDA	ROSCA MACHO	REF.	EUROS	PESO UNID.
1 1/2"	1 1/2"	165002	59,15	2,700
2"	2"	165003	65,22	3,700
2 1/2"	2 1/2"	165004	75,40	5,300
3"	3"	165005	87,32	6,600

INCLUIDO KIT DE MONTAJE

**TORNILLERÍA**
**TORNILLO M-12x65 ZINCADO C/T**

REF.	EUROS	UNID. DE EMBALAJE	PESO UNID.
202007	0,99	5	0,054

**TORNILLO M-12x80 ZINCADO C/T**

REF.	EUROS	UNID. DE EMBALAJE	PESO UNID.
202018	1,23	5	0,058

**TORNILLO M-16x55 ZINCADO C/T**

REF.	EUROS	UNID. DE EMBALAJE	PESO UNID.
202008	1,82	5	0,087

**TORNILLO M-16x60 ZINCADO C/T**

REF.	EUROS	UNID. DE EMBALAJE	PESO UNID.
202009	1,85	5	0,098

**TORNILLO M-16x70 ZINCADO C/T**

REF.	EUROS	UNID. DE EMBALAJE	PESO UNID.
202010	1,87	5	0,116

**TORNILLO M-16x80 ZINCADO C/T**

REF.	EUROS	UNID. DE EMBALAJE	PESO UNID.
202011	1,91	5	0,128

**TORNILLO M-20x70 ZINCADO C/T**

REF.	EUROS	UNID. DE EMBALAJE	PESO UNID.
202015	2,05	10	0,115

**TORNILLO M-20x80 ZINCADO C/T**

REF.	EUROS	UNID. DE EMBALAJE	PESO UNID.
202017	3,53	10	0,124

**ESPÁRRAGO M-16x60 ZINCADO C/T**

REF.	EUROS	UNID. DE EMBALAJE	PESO UNID.
01611107	0,82	10	0,080

**ESPÁRRAGO M-16x70 ZINCADO C/T**

REF.	EUROS	UNID. DE EMBALAJE	PESO UNID.
01611101	0,91	10	0,094

**ESPÁRRAGO M-16x80 ZINCADO C/T**

REF.	EUROS	UNID. DE EMBALAJE	PESO UNID.
01611108	1,00	10	0,100

**ESPÁRRAGO M-16x90 ZINCADO C/T**

REF.	EUROS	UNID. DE EMBALAJE	PESO UNID.
01611109	1,09	10	0,110

Revisión A

# NOTAS

Revisión A



# VÁLVULAS ASIEN TO

## SERIE BS BS

Revisión A  
**23/01**



Revisión A

**ÍNDICE**

**PAG. 39-43.....VÁLVULAS SERIE BS**

**PAG. 44-47..... ACCESORIOS VÁLVULAS SERIE BS**

**PAG. 48..... TORNILLERIA VÁLVULAS EMBRIDADAS**



**BS**

Revisión A

VÁLVULAS ENTRADA SERIE BS PARA CONTADORES Ø 13, 15 Y 20



**ENTRADA FIJA DN 13-15**

DISPOSITIVO ANTIRRETORNO	SI	NO	REF.	EUROS	UNID. DE EMBALAJE	PESO UNID.
	<input checked="" type="checkbox"/>	<input type="checkbox"/>	100001	15,24	30	0,400

**ENTRADA FIJA DN 20**

DISPOSITIVO ANTIRRETORNO	SI	NO	REF.	EUROS	UNID. DE EMBALAJE	PESO UNID.
	<input checked="" type="checkbox"/>	<input type="checkbox"/>	100011	21,67	30	0,600

OPCIÓN DE MANETA DE LATÓN. CONSULTAR.



**ENTRADA ORIENTABLE DN 13-15**

DISPOSITIVO ANTIRRETORNO	SI	NO	REF.	EUROS	UNID. DE EMBALAJE	PESO UNID.
	<input checked="" type="checkbox"/>	<input type="checkbox"/>	101001	16,85	30	0,500

**ENTRADA ORIENTABLE DN 20**

DISPOSITIVO ANTIRRETORNO	SI	NO	REF.	EUROS	UNID. DE EMBALAJE	PESO UNID.
	<input checked="" type="checkbox"/>	<input type="checkbox"/>	101011	22,02	30	0,700

OPCIÓN DE MANETA DE LATÓN. CONSULTAR.



**ENTRADA FIJA Y ANTIFRAUDE DN 13-15**

DISPOSITIVO ANTIRRETORNO	SI	NO	REF.	EUROS	UNID. DE EMBALAJE	PESO UNID.
	<input checked="" type="checkbox"/>	<input type="checkbox"/>	100002	19,78	30	0,400

**ENTRADA FIJA Y ANTIFRAUDE DN 20**

DISPOSITIVO ANTIRRETORNO	SI	NO	REF.	EUROS	UNID. DE EMBALAJE	PESO UNID.
	<input checked="" type="checkbox"/>	<input type="checkbox"/>	100022	21,47	30	0,450



**ENTRADA ORIENTABLE Y ANTIFRAUDE DN 13-15**

DISPOSITIVO ANTIRRETORNO	SI	NO	REF.	EUROS	UNID. DE EMBALAJE	PESO UNID.
	<input checked="" type="checkbox"/>	<input type="checkbox"/>	101002	22,01	30	0,400

**ENTRADA ORIENTABLE Y ANTIFRAUDE DN 20**

DISPOSITIVO ANTIRRETORNO	SI	NO	REF.	EUROS	UNID. DE EMBALAJE	PESO UNID.
	<input checked="" type="checkbox"/>	<input type="checkbox"/>	101012	27,92	30	0,450

INCLUIDO EL MANGUITO DE CONEXIÓN AL CONTADOR  
FILTROS PARA VÁLVULAS BS PÁG. 46

Revisión A

VÁLVULAS ENTRADA SERIE BS PARA CONTADORES Ø 13, 15 Y 20



**ENTRADA DN 13-15**

DISPOSITIVO ANTIRRETORNO	SI	NO	REF.	EUROS	UNID. DE EMBALAJE	PESO UNID.
	<input checked="" type="checkbox"/>	<input type="checkbox"/>	102001	13,46	50	0,350

**ENTRADA DN 20**

DISPOSITIVO ANTIRRETORNO	SI	NO	REF.	EUROS	UNID. DE EMBALAJE	PESO UNID.
	<input checked="" type="checkbox"/>	<input type="checkbox"/>	102011	19,61	30	0,400

OPCIÓN DE MANETA DE LATÓN. CONSULTAR.



**ENTRADA ANTIFRAUDE DN 13-15**

DISPOSITIVO ANTIRRETORNO	SI	NO	REF.	EUROS	UNID. DE EMBALAJE	PESO UNID.
	<input checked="" type="checkbox"/>	<input type="checkbox"/>	102002	15,10	30	0,350

**ENTRADA ANTIFRAUDE DN 20**

DISPOSITIVO ANTIRRETORNO	SI	NO	REF.	EUROS	UNID. DE EMBALAJE	PESO UNID.
	<input checked="" type="checkbox"/>	<input type="checkbox"/>	102012	20,82	30	0,400

Revisión A



**ENTRADA CON CONEXIÓN A P.E. EXT 25 DN 13-15**

DISPOSITIVO ANTIRRETORNO	SI	NO	REF.	EUROS	UNID. DE EMBALAJE	PESO UNID.
	<input checked="" type="checkbox"/>	<input type="checkbox"/>	102003	19,55	50	0,500

**ENTRADA CON CONEXIÓN A P.E. EXT 32 DN 20**

DISPOSITIVO ANTIRRETORNO	SI	NO	REF.	EUROS	UNID. DE EMBALAJE	PESO UNID.
	<input checked="" type="checkbox"/>	<input type="checkbox"/>	102013	25,37	30	0,700

OPCIÓN DE MANETA DE LATÓN. CONSULTAR.



**ENTRADA ANTIFRAUDE Y CONEXIÓN A P.E. EXT 25 DN 13-15**

DISPOSITIVO ANTIRRETORNO	SI	NO	REF.	EUROS	UNID. DE EMBALAJE	PESO UNID.
	<input checked="" type="checkbox"/>	<input type="checkbox"/>	102004	21,45	50	0,350

**ENTRADA ANTIFRAUDE Y CONEXIÓN A P.E. EXT 32 DN 20**

DISPOSITIVO ANTIRRETORNO	SI	NO	REF.	EUROS	UNID. DE EMBALAJE	PESO UNID.
	<input checked="" type="checkbox"/>	<input type="checkbox"/>	102014	27,27	30	0,600

INCLUIDO EL MANGUITO DE CONEXIÓN AL CONTADOR  
FILTROS PARA VÁLVULAS BS PÁG. 46



VÁLVULAS SALIDA SERIE BS PARA CONTADORES Ø 13, 15 Y 20



**SALIDA DN 13-15**

DISPOSITIVO ANTIRRETORNO	SI	NO	REF.	EUROS	UNID. DE EMBALAJE	PESO UNID.
	<input checked="" type="checkbox"/>	<input type="checkbox"/>	103001	11,60	50	0,300

**SALIDA DN 20**

DISPOSITIVO ANTIRRETORNO	SI	NO	REF.	EUROS	UNID. DE EMBALAJE	PESO UNID.
	<input checked="" type="checkbox"/>	<input type="checkbox"/>	103011	18,95	40	0,550

OPCIÓN DE MANETA DE LATÓN. CONSULTAR.



**SALIDA DN 13-15**

DISPOSITIVO ANTIRRETORNO	SI	NO	REF.	EUROS	UNID. DE EMBALAJE	PESO UNID.
	<input checked="" type="checkbox"/>	<input type="checkbox"/>	104001	12,42	50	0,350

**SALIDA DN 20**

DISPOSITIVO ANTIRRETORNO	SI	NO	REF.	EUROS	UNID. DE EMBALAJE	PESO UNID.
	<input checked="" type="checkbox"/>	<input type="checkbox"/>	104011	19,85	40	0,400

OPCIÓN DE MANETA DE LATÓN. CONSULTAR.



**SALIDA CON PURGA DN 13-15**

DISPOSITIVO ANTIRRETORNO	SI	NO	REF.	EUROS	UNID. DE EMBALAJE	PESO UNID.
	<input checked="" type="checkbox"/>	<input type="checkbox"/>	103006	19,86	40	0,550

**SALIDA CON PURGA DN 20**

DISPOSITIVO ANTIRRETORNO	SI	NO	REF.	EUROS	UNID. DE EMBALAJE	PESO UNID.
	<input checked="" type="checkbox"/>	<input type="checkbox"/>	103016	26,20	25	0,800

OPCIÓN DE MANETA DE LATÓN. CONSULTAR.



**SALIDA ANTIFRAUDE DN 13-15**

DISPOSITIVO ANTIRRETORNO	SI	NO	REF.	EUROS	UNID. DE EMBALAJE	PESO UNID.
	<input checked="" type="checkbox"/>	<input type="checkbox"/>	104002	13,50	50	0,300

**SALIDA ANTIFRAUDE DN 20**

DISPOSITIVO ANTIRRETORNO	SI	NO	REF.	EUROS	UNID. DE EMBALAJE	PESO UNID.
	<input checked="" type="checkbox"/>	<input type="checkbox"/>	104012	19,59	40	0,550

INCLUIDO EL MANGUITO DE CONEXIÓN AL CONTADOR

Revisión A

VÁLVULAS SALIDA SERIE BS PARA CONTADORES Ø 13, 15 Y 20



**SALIDA AUTOMÁTICA DN 13-15**

	REF.	EUROS	UNID. DE EMBALAJE	PESO UNID.
<b>DISPOSITIVO ANTIRRETORNO</b> <b>SI</b> <input checked="" type="checkbox"/> <b>NO</b> <input type="checkbox"/>	104022	8,43	50	0,300



**SALIDA CON CONEXIÓN A P-E Ø EXT 25 DN 13-15**

	REF.	EUROS	UNID. DE EMBALAJE	PESO UNID.
<b>DISPOSITIVO ANTIRRETORNO</b> <b>SI</b> <input checked="" type="checkbox"/> <b>NO</b> <input type="checkbox"/>	104003	20,09	50	0,500

**SALIDA CON CONEXIÓN A P-E Ø EXT 32 DN 20**

	REF.	EUROS	UNID. DE EMBALAJE	PESO UNID.
<b>DISPOSITIVO ANTIRRETORNO</b> <b>SI</b> <input checked="" type="checkbox"/> <b>NO</b> <input type="checkbox"/>	104013	26,35	30	0,700

OPCIÓN DE MANETA DE LATÓN. CONSULTAR.



**SALIDA CON PURGA Y CONEXIÓN A P-E Ø EXT 25 DN 13-15**

	REF.	EUROS	UNID. DE EMBALAJE	PESO UNID.
<b>DISPOSITIVO ANTIRRETORNO</b> <b>SI</b> <input checked="" type="checkbox"/> <b>NO</b> <input type="checkbox"/>	103005	27,30	25	0,600

**SALIDA CON PURGA CONEXIÓN A P-E Ø EXT 32 DN 20**

	REF.	EUROS	UNID. DE EMBALAJE	PESO UNID.
<b>DISPOSITIVO ANTIRRETORNO</b> <b>SI</b> <input checked="" type="checkbox"/> <b>NO</b> <input type="checkbox"/>	103015	29,52	15	0,800

OPCIÓN DE MANETA DE LATÓN. CONSULTAR.



**SALIDA CON PURGA Y CONEXIÓN A P-E Ø EXT 25 DN 13-15**

	REF.	EUROS	UNID. DE EMBALAJE	PESO UNID.
<b>DISPOSITIVO ANTIRRETORNO</b> <b>SI</b> <input checked="" type="checkbox"/> <b>NO</b> <input type="checkbox"/>	104005	29,03	25	0,500

**SALIDA CON PURGA CONEXIÓN A P-E Ø EXT 32 DN 20**

	REF.	EUROS	UNID. DE EMBALAJE	PESO UNID.
<b>DISPOSITIVO ANTIRRETORNO</b> <b>SI</b> <input checked="" type="checkbox"/> <b>NO</b> <input type="checkbox"/>	104015	38,22	12	0,800

OPCIÓN DE MANETA DE LATÓN. CONSULTAR.  
INCLUIDO EL MANGUITO DE CONEXIÓN AL CONTADOR

Revisión A

VÁLVULAS SALIDA SERIE BS PARA CONTADORES Ø 13, 15 Y 20



**SALIDA CON PURGA DN 15**

DISPOSITIVO ANTIRRETORNO	SI	NO	REF.	EUROS	UNID. DE EMBALAJE	PESO UNID.
	<input checked="" type="checkbox"/>	<input type="checkbox"/>	104006	21,35	40	0,450

**SALIDA CON PURGA DN 20**

DISPOSITIVO ANTIRRETORNO	SI	NO	REF.	EUROS	UNID. DE EMBALAJE	PESO UNID.
	<input checked="" type="checkbox"/>	<input type="checkbox"/>	104016	32,19	20	0,850

OPCIÓN DE MANETA DE LATÓN. CONSULTAR.



**SALIDA CON PURGA DN 20**

DISPOSITIVO ANTIRRETORNO	SI	NO	REF.	EUROS	UNID. DE EMBALAJE	PESO UNID.
	<input checked="" type="checkbox"/>	<input type="checkbox"/>	104026	22,61	20	0,600

OPCIÓN DE MANETA DE LATÓN. CONSULTAR.  
INCLUIDO EL MANGUITO DE CONEXIÓN AL CONTADOR

Revisión A

ACCESORIOS VÁLVULAS BS



**MONTURA CON PISTONCILLO EPDM DN 13-15**

REF.	EUROS	UNID. DE EMBALAJE	PESO UNID.
1029001	6,41	10	0,140

**MONTURA CON PISTONCILLO EPDM DN 20**

REF.	EUROS	UNID. DE EMBALAJE	PESO UNID.
1029003	10,03	10	0,225

OPCIÓN DE MANETA DE LATÓN. CONSULTAR.



**MONTURA FIJA CON PORTASOLETA DN 13-15**

REF.	EUROS	UNID. DE EMBALAJE	PESO UNID.
1029002	7,32	10	0,150

**MONTURA FIJA CON PORTASOLETA DN 20**

REF.	EUROS	UNID. DE EMBALAJE	PESO UNID.
1029005	10,15	10	0,235

OPCIÓN DE MANETA DE LATÓN. CONSULTAR.



**PISTONCILLO NBR DN 13-15**

REF.	EUROS	UNID. DE EMBALAJE	PESO UNID.
1025004	0,51	25	0,003

**PISTONCILLO LATÓN CAUCHO DN 13-15**

REF.	EUROS	UNID. DE EMBALAJE	PESO UNID.
1025053	2,38	25	0,012

**PISTONCILLO LATÓN CAUCHO DN 20**

REF.	EUROS	UNID. DE EMBALAJE	PESO UNID.
1025054	3,01	10	0,016



**CUERPO PURGA PARA VÁLVULA SALIDA BATERÍA DN 20**

REF.	EUROS	UNID. DE EMBALAJE	PESO UNID.
1020005	9,44	10	0,325



**CUERPO PURGA PARA VÁLVULA SALIDA ACOMETIDA DN 13-15**

REF.	EUROS	UNID. DE EMBALAJE	PESO UNID.
1020002	10,04	10	0,200

**CUERPO PURGA PARA VÁLVULA SALIDA ACOMETIDA DN 20**

REF.	EUROS	UNID. DE EMBALAJE	PESO UNID.
1020006	14,84	10	0,300

Revisión A

**ACCESORIOS VÁLVULAS BS**
**MANGUITOS PARA VÁLVULAS DN-13-15 SERIE BS**
**CONEXIÓN A VÁLVULA 21,8 IZQUIERDAS**

**DN 15 -1/2" (LL13)**

REF.	EUROS	UNID. DE EMBALAJE	PESO UNID.
1021012	2,17	10	0,050

**DN 15 -3/4"**

REF.	EUROS	UNID. DE EMBALAJE	PESO UNID.
1021034	2,34	10	0,060

**DN 15 - 7/8"**

REF.	EUROS	UNID. DE EMBALAJE	PESO UNID.
1021078	2,45	10	0,080

**DN 15 - 1"**

REF.	EUROS	UNID. DE EMBALAJE	PESO UNID.
1021100	3,12	10	0,080

**MANGUITOS PARA VÁLVULAS DN 20 SERIE BS**
**CONEXIÓN A VÁLVULA 7/8" IZQUIERDAS**

**DN 20 - 3/4"**

REF.	EUROS	UNID. DE EMBALAJE	PESO UNID.
1022034	3,44	10	0,098

**DN 20 - 7/8"**

REF.	EUROS	UNID. DE EMBALAJE	PESO UNID.
1022078	3,27	10	0,095

**DN 20 - 1"**

REF.	EUROS	UNID. DE EMBALAJE	PESO UNID.
1022100	3,15	10	0,090

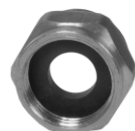
**MANGUITOS PARA VÁLVULAS DN 20 SERIE BT**
**CONEXIÓN A VÁLVULA 3/4" IZQUIERDAS**

**DN 20 -LL13**

REF.	EUROS	UNID. DE EMBALAJE	PESO UNID.
1021101	2,34	10	0,060

**DN 20 -3/4"**

REF.	EUROS	UNID. DE EMBALAJE	PESO UNID.
1022118	2,34	10	0,090

**DN 20 - 7/8"**

REF.	EUROS	UNID. DE EMBALAJE	PESO UNID.
1022119	3,07	10	0,090

**DN 20 - 1"**

REF.	EUROS	UNID. DE EMBALAJE	PESO UNID.
1022120	3,15	10	0,090

**MANGUITOS PARA VÁLVULAS DN 20 SERIE BS**
**CONEXIÓN A VÁLVULA 1" IZQUIERDAS**

**DN 20 - 3/4"**

REF.	EUROS	UNID. DE EMBALAJE	PESO UNID.
1022116	3,15	10	0,095

**DN 20 - 7/8"**

REF.	EUROS	UNID. DE EMBALAJE	PESO UNID.
1022117	3,15	10	0,085

**DN 20 - 1"**

REF.	EUROS	UNID. DE EMBALAJE	PESO UNID.
1022115	3,12	10	0,085

\*\*INCLUIDA JUNTA EPDM EN TODAS LAS REFERENCIAS DE ESTA PÁGINA\*\*

Revisión A

ACCESORIOS VÁLVULAS SERIE BS



**FILTRO PARA VÁLVULA DE ENTRADA DN 13-15**

REF.	EUROS	UNID. DE EMBALAJE	PESO UNID.
01790001	12,21	10	0,200

**FILTRO PARA VÁLVULA ENTRADA DN 20**

REF.	EUROS	UNID. DE EMBALAJE	PESO UNID.
01790002	18,49	10	0,250



**FILTRO PARA VÁLVULA DE ENTRADA DN 13-15 SALIDA ROSCA H 1/2"**

REF.	EUROS	UNID. DE EMBALAJE	PESO UNID.
11790001	8,29	10	0,175

**FILTRO PARA VÁLVULA ENTRADA DN 20 SALIDA ROSCA H 3/4"**

REF.	EUROS	UNID. DE EMBALAJE	PESO UNID.
11790002	14,10	10	0,300

Revisión A

ACCESORIOS VÁLVULAS SERIE BS



**JUNTA PLANA EPDM PARA VÁLVULA ENTRADA FIJA DN 15 BS**

REF.	EUROS	UNID. DE EMBALAJE	PESO UNID.
1026110	0,50	25	0,012

**JUNTA PLANA EPDM PARA VÁLVULA ENTRADA FIJA DN 20 BS**

REF.	EUROS	UNID. DE EMBALAJE	PESO UNID.
1026111	0,66	25	0,014

**JUNTA PLANA EPDM PARA VÁLVULA ENTRADA ORIENTABLE DN 15 BS**

REF.	EUROS	UNID. DE EMBALAJE	PESO UNID.
1035110	0,50	25	0,014

**JUNTA PLANA EPDM PARA VÁLVULA ENTRADA ORIENTABLE DN 20 BS**

REF.	EUROS	UNID. DE EMBALAJE	PESO UNID.
10029051	0,83	25	0,014



**JUNTA PLANA EPDM PARA MANGUITO DN 15-1/2" BS**

REF.	EUROS	UNID. DE EMBALAJE	PESO UNID.
1025114	0,14	10	0,005

**JUNTA PLANA EPDM PARA MANGUITO DN 15-3/4" BS**

REF.	EUROS	UNID. DE EMBALAJE	PESO UNID.
1025111	0,17	10	0,007

**JUNTA PLANA EPDM PARA MANGUITO DN 15-7/8" BS**

REF.	EUROS	UNID. DE EMBALAJE	PESO UNID.
1025112	0,22	10	0,008

**JUNTA PLANA EPDM PARA MANGUITO DN 15-1" BS**

REF.	EUROS	UNID. DE EMBALAJE	PESO UNID.
1025113	0,27	10	0,008



**JUNTA PLANA EPDM PARA MANGUITO DN 20-3/4" BS**

REF.	EUROS	UNID. DE EMBALAJE	PESO UNID.
1025161	0,22	10	0,009

**JUNTA PLANA EPDM PARA MANGUITO DN 20-7/8" BS**

REF.	EUROS	UNID. DE EMBALAJE	PESO UNID.
1025162	0,22	10	0,011

**JUNTA PLANA EPDM PARA MANGUITO DN 20-1" BS**

REF.	EUROS	UNID. DE EMBALAJE	PESO UNID.
1025163	0,23	10	0,011

Revisión A

TORNILLERÍA

**TORNILLO M-10x30 INOX C/T**

REF.	EUROS	UNID. DE EMBALAJE	PESO UNID.
202019	0,86	10	0,020

**TORNILLO M-10x20 ZINCADO**

REF.	EUROS	UNID. DE EMBALAJE	PESO UNID.
202001	0,25	10	0,015

**TORNILLO M-10x30 ZINCADO**

REF.	EUROS	UNID. DE EMBALAJE	PESO UNID.
202003	0,30	10	0,020

**TORNILLO M-10x35 ZINCADO C/T**

REF.	EUROS	UNID. DE EMBALAJE	PESO UNID.
202005	0,35	10	0,025



**TORNILLO M-10x20 ZINCADO C/BASE**

REF.	EUROS	UNID. DE EMBALAJE	PESO UNID.
202021	0,50	10	0,010

**TORNILLO M-10x25 ZINCADO C/BASE**

REF.	EUROS	UNID. DE EMBALAJE	PESO UNID.
202020	0,54	10	0,010

**TORNILLO M-12x20 ZINCADO C/BASE**

REF.	EUROS	UNID. DE EMBALAJE	PESO UNID.
202050	0,81	10	0,015

**TORNILLO M-12x25 ZINCADO C/BASE**

REF.	EUROS	UNID. DE EMBALAJE	PESO UNID.
202075	0,90	10	0,015

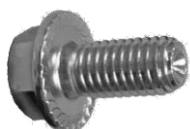

Revisión A



# VÁLVULAS ESFERA

## SERIE BT

Revisión A  
**23/01**

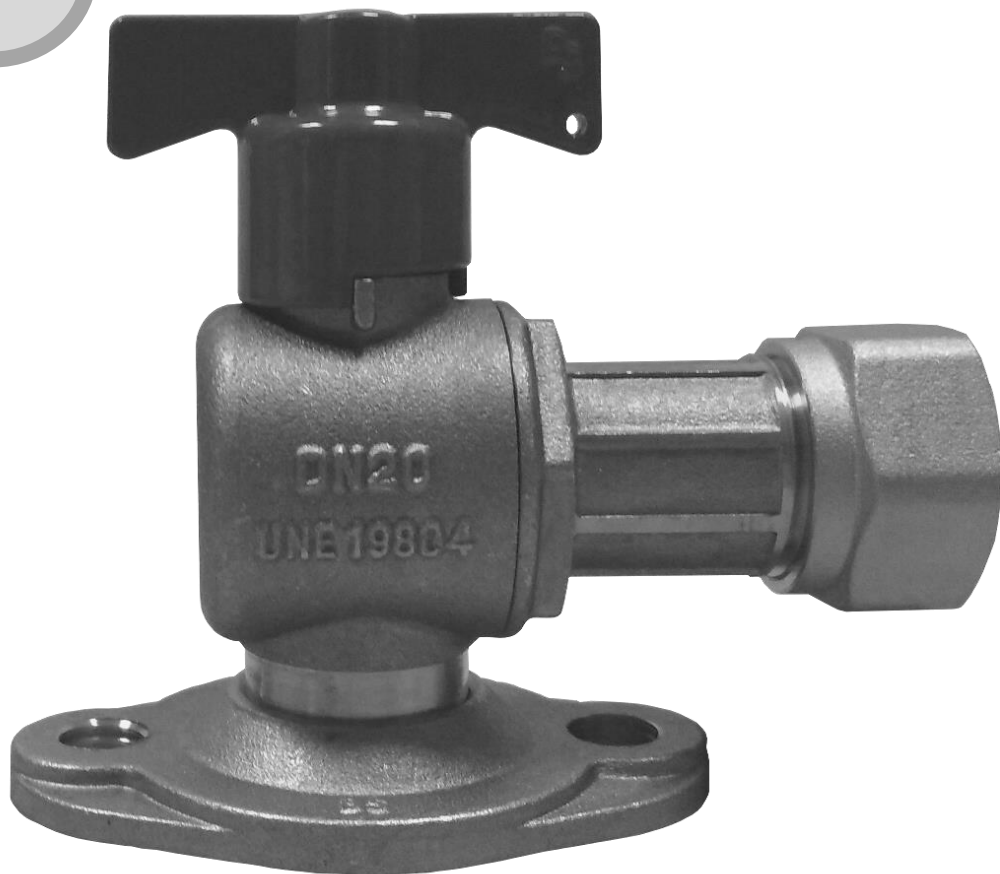

Revisión A

**ÍNDICE**

PAG. 51-53..... VÁLVULAS SERIE BT

PAG. 54-55..... VÁLVULAS LINEALES CON SISTEMA ANTIFRAUDE MAGNÉTICO

PAG. 56..... VÁLVULAS H-H PN25 EQUIPADAS CON DISPOSITIVO ANTIFRAUDE

PAG. 57-60..... ESPECIFICACIONES TÉCNICAS DE TAPÓN Y LLAVE ANTIFRAUDE



Revisión A

VÁLVULAS ENTRADA SERIE BT CON SISTEMA ANTIFRAUDE MAGNÉTICO PARA CONTADORES DN 13, 15 Y 20mm.



**ENTRADA ORIENTABLE DN 20 MANGUITO 3/4" – 7/8" – 1"**

DISPOSITIVO ANTIRRETORNO	SI	NO	REF.	EUROS	UNID. DE EMBALAJE	PESO UNID.
	<input type="checkbox"/>	<input checked="" type="checkbox"/>	BT101011	23,56	32	0,550

OPCIÓN DE MANETA DE LATÓN. CONSULTAR



**ENTRADA ORIENTABLE CON TAPÓN ANTIFRAUDE PARA CONTADOR DN 20 MANGUITO 3/4" – 7/8" – 1"**

DISPOSITIVO ANTIRRETORNO	SI	NO	REF.	EUROS	UNID. DE EMBALAJE	PESO UNID.
	<input type="checkbox"/>	<input checked="" type="checkbox"/>	BT101111	25,74	32	0,500



**ENTRADA ROSCADA 3/4" DN 13-15 RACOR 7/8"-3/4"**

DISPOSITIVO ANTIRRETORNO	SI	NO	REF.	EUROS	UNID. DE EMBALAJE	PESO UNID.
	<input type="checkbox"/>	<input checked="" type="checkbox"/>	BT104113	18,98	32	0,450

**ENTRADA ROSCADA 1" DN 20 RACOR 1"**

DISPOSITIVO ANTIRRETORNO	SI	NO	REF.	EUROS	UNID. DE EMBALAJE	PESO UNID.
	<input type="checkbox"/>	<input checked="" type="checkbox"/>	BT104112	20,48	32	0,550

OPCIÓN DE MANETA DE LATÓN. CONSULTAR



**ENTRADA ROSCADA 3/4" CON TAPÓN ANTIFRAUDE PARA CONTADOR DN 13-15 RACOR 7/8"-3/4"**

DISPOSITIVO ANTIRRETORNO	SI	NO	REF.	EUROS	UNID. DE EMBALAJE	PESO UNID.
	<input type="checkbox"/>	<input checked="" type="checkbox"/>	BT104123	19,67	32	0,350

**ENTRADA ROSCADA 1" CON TAPÓN ANTIFRAUDE PARA CONTADOR DN 20 RACOR 1"**

DISPOSITIVO ANTIRRETORNO	SI	NO	REF.	EUROS	UNID. DE EMBALAJE	PESO UNID.
	<input type="checkbox"/>	<input checked="" type="checkbox"/>	BT104122	20,74	32	0,508

DISPUESTAS CON BLOQUEO DE VOLANTE PARA POSICIÓN DE MÍNIMO VITAL CON SISTEMA DE SEGURIDAD

INCLUIDOS MANGUITOS Y RACORES DE CONEXIÓN AL CONTADOR

Revisión A

VÁLVULAS ENTRADA SERIE BT CON SISTEMA ANTIFRAUDE MAGNÉTICO PARA CONTADORES DN 13, 15 Y 20 mm.



**ENTRADA ROSCADA 1" PARA CONTADOR DN 13-15 RACOR 7/8"-3/4"**

DISPOSITIVO ANTIRRETORNO	SI	NO	REF.	EUROS	UNID. DE EMBALAJE	PESO UNID.
	<input type="checkbox"/>	<input checked="" type="checkbox"/>	BT104011	21,11	32	0,460

OPCIÓN DE MANETA DE LATÓN. CONSULTAR



**ENTRADA ROSCADA 1" CON TAPÓN ANTIFRAUDE PARA CONTADOR DN 13-15 RACOR 7/8"-3/4"**

DISPOSITIVO ANTIRRETORNO	SI	NO	REF.	EUROS	UNID. DE EMBALAJE	PESO UNID.
	<input type="checkbox"/>	<input checked="" type="checkbox"/>	BT104015	21,71	32	0,360



**ENTRADA CON CONEXIÓN A P.E. ØEXT 25 PARA CONTADOR DN 13-15**

DISPOSITIVO ANTIRRETORNO	SI	NO	REF.	EUROS	UNID. DE EMBALAJE	PESO UNID.
	<input type="checkbox"/>	<input checked="" type="checkbox"/>	BT104813	25,38	32	0,628

**ENTRADA CON CONEXIÓN A P.E. ØEXT 32 PARA CONTADOR DN 20**

DISPOSITIVO ANTIRRETORNO	SI	NO	REF.	EUROS	UNID. DE EMBALAJE	PESO UNID.
	<input type="checkbox"/>	<input checked="" type="checkbox"/>	BT104811	28,81	32	0,754

OPCIÓN DE MANETA DE LATÓN. CONSULTAR



**ENTRADA CON CONEXIÓN A P.E. ØEXT 25 CON TAPÓN ANTIFRAUDE PARA CONTADOR DN 13-15 RACOR 7/8"-3/4"**

DISPOSITIVO ANTIRRETORNO	SI	NO	REF.	EUROS	UNID. DE EMBALAJE	PESO UNID.
	<input type="checkbox"/>	<input checked="" type="checkbox"/>	BT104814	25,72	32	0,581

**ENTRADA CON CONEXIÓN A P.E. ØEXT 32 CON TAPÓN ANTIFRAUDE PARA CONTADOR DN 20 RACOR 1"**

DISPOSITIVO ANTIRRETORNO	SI	NO	REF.	EUROS	UNID. DE EMBALAJE	PESO UNID.
	<input type="checkbox"/>	<input checked="" type="checkbox"/>	BT104812	30,84	32	0,707

DISPUESTAS CON BLOQUEO DE VOLANTE PARA POSICIÓN DE MÍNIMO VITAL CON SISTEMA DE SEGURIDAD

INCLUIDOS RACORES DE CONEXIÓN AL CONTADOR

Revisión A

VÁLVULAS SALIDA SERIE BT PARA CONTADORES DN 13, 15 Y 20 mm.  
CON ANTIRRETORNO Y PURGA INCORPORADA



**SALIDA BATERÍA PARA CONTADOR DN 20 MANGUITO 3/4" - 1"**

DISPOSITIVO ANTIRRETORNO	SI	NO	REF.	EUROS	UNID. DE EMBALAJE	PESO UNID.
	<input checked="" type="checkbox"/>	<input type="checkbox"/>	BT102011	20,76	32	0,500

OPCIÓN DE MANETA DE LATÓN. CONSULTAR



**SALIDA ROSCADA 3/4" PARA CONTADOR DN 13-15 RACOR 3/4"**

DISPOSITIVO ANTIRRETORNO	SI	NO	REF.	EUROS	UNID. DE EMBALAJE	PESO UNID.
	<input checked="" type="checkbox"/>	<input type="checkbox"/>	BT105001	20,63	32	0,450

**SALIDA ROSCADA 1" PARA CONTADOR DN 20 RACOR 1"**

DISPOSITIVO ANTIRRETORNO	SI	NO	REF.	EUROS	UNID. DE EMBALAJE	PESO UNID.
	<input checked="" type="checkbox"/>	<input type="checkbox"/>	BT105101	20,90	32	0,595

OPCIÓN DE MANETA DE LATÓN. CONSULTAR



**SALIDA ROSCADA 1" PARA CONTADOR DN 13-15 RACOR 3/4"**

DISPOSITIVO ANTIRRETORNO	SI	NO	REF.	EUROS	UNID. DE EMBALAJE	PESO UNID.
	<input checked="" type="checkbox"/>	<input type="checkbox"/>	BT105501	23,46	32	0,350

OPCIÓN DE MANETA DE LATÓN. CONSULTAR



**SALIDA CON CONEXIÓN A P.E. ØEXT 25 PARA CONTADOR DN 13-15**

DISPOSITIVO ANTIRRETORNO	SI	NO	REF.	EUROS	UNID. DE EMBALAJE	PESO UNID.
	<input checked="" type="checkbox"/>	<input type="checkbox"/>	BT105801	26,81	32	0,663

**SALIDA CON CONEXIÓN A P.E. ØEXT 32 PARA CONTADOR DN 20**

DISPOSITIVO ANTIRRETORNO	SI	NO	REF.	EUROS	UNID. DE EMBALAJE	PESO UNID.
	<input checked="" type="checkbox"/>	<input type="checkbox"/>	BT105811	29,20	32	0,794

DISPUESTAS CON BLOQUEO DE VOLANTE PARA POSICIÓN DE MÍNIMO VITAL CON SISTEMA DE SEGURIDAD

OPCIÓN DE MANETA DE LATÓN. CONSULTAR  
INCLUIDOS MANGUITOS Y RACORES DE CONEXIÓN AL CONTADOR

Revisión A

**VÁLVULAS LINEALES H SERIE BT PN25 CON SISTEMA ANTIFRAUDE MAGNÉTICO**



**VÁLVULA H-H 1/2" DN15**

REF.	EUROS	UNID. DE EMBALAJE	PESO UNID.
BT106001	7,43	50	0,233

**VÁLVULA H-H 3/4" DN20**

REF.	EUROS	UNID. DE EMBALAJE	PESO UNID.
BT106201	10,19	50	0,319

**VÁLVULA H-H 1" DN25**

REF.	EUROS	UNID. DE EMBALAJE	PESO UNID.
BT106401	16,90	50	0,454



**VÁLVULA H-H 1/2" DN15 CON TAPÓN DE BLOQUEO MAGNÉTICO**

REF.	EUROS	UNID. DE EMBALAJE	PESO UNID.
BT106101	8,46	50	0,232

**VÁLVULA H-H 3/4" DN20 CON TAPÓN DE BLOQUEO MAGNÉTICO BLOQUEO**

REF.	EUROS	UNID. DE EMBALAJE	PESO UNID.
BT106301	11,66	50	0,316

**VÁLVULA H-H 1" DN25 CON TAPÓN DE BLOQUEO MAGNÉTICO**

REF.	EUROS	UNID. DE EMBALAJE	PESO UNID.
BT106501	17,99	50	0,408



**VÁLVULA H 1/2" DN15 CON RACOR DE CONEXIÓN 3/4"-7/8"**

REF.	EUROS	UNID. DE EMBALAJE	PESO UNID.
BT106002	12,72	50	0,285

**VÁLVULA H 3/4" DN20 CON RACOR DE CONEXIÓN 3/4"-7/8"-1"**

REF.	EUROS	UNID. DE EMBALAJE	PESO UNID.
BT106202	15,05	50	0,420

**VÁLVULA H 1" DN25 CON RACOR DE CONEXIÓN 1 1/4"**

REF.	EUROS	UNID. DE EMBALAJE	PESO UNID.
BT106402	26,07	50	0,650



**VÁLVULA H 1/2" DN15 RACOR DE CONEXIÓN 3/4"-7/8" Y TAPÓN DE BLOQUEO MAGNÉTICO**

REF.	EUROS	UNID. DE EMBALAJE	PESO UNID.
BT106102	11,03	50	0,245

**VÁLVULA H 3/4" DN20 RACOR DE CONEXIÓN 3/4"-7/8"-1" Y TAPÓN DE BLOQUEO MAGNÉTICO**

REF.	EUROS	UNID. DE EMBALAJE	PESO UNID.
BT106302	16,56	50	0,416

**VÁLVULA H 1" DN25 RACOR DE CONEXIÓN 1 1/4" Y TAPÓN DE BLOQUEO MAGNÉTICO**

REF.	EUROS	UNID. DE EMBALAJE	PESO UNID.
BT106502	26,59	50	0,646

DISPUESTAS CON BLOQUEO DE VOLANTE PARA POSICIÓN DE MÍNIMO VITAL CON SISTEMA DE SEGURIDAD

Revisión A

**VÁLVULAS LINEALES SERIE BT PN25 CON CUADRADILLO 30x30 Y SISTEMA ANTIFRAUDE MAGNÉTICO**



**VÁLVULA H-H 1/2" DN15**

REF.	EUROS	UNID. DE EMBALAJE	PESO UNID.
BT107401	12,33	50	0,300

**VÁLVULA H-H 3/4" DN20**

REF.	EUROS	UNID. DE EMBALAJE	PESO UNID.
BT107402	15,07	50	0,380

**VÁLVULA H-H 1" DN25**

REF.	EUROS	UNID. DE EMBALAJE	PESO UNID.
BT107403	21,28	50	0,505

**VÁLVULAS LINEALES PN25 CON SISTEMA DE CORTE ANTIFRAUDE MAGNÉTICO**



**VÁLVULA H-H 1/2" DN15**

REF.	EUROS	UNID. DE EMBALAJE	PESO UNID.
BTM106401	8,18	50	0,167

**VÁLVULA H-H 3/4" DN20**

REF.	EUROS	UNID. DE EMBALAJE	PESO UNID.
BTM106402	11,60	50	0,239

**VÁLVULA H-H 1" DN25**

REF.	EUROS	UNID. DE EMBALAJE	PESO UNID.
BTM106403	16,06	50	0,324

**VÁLVULA H-H 1 1/4" DN30**

REF.	EUROS	UNID. DE EMBALAJE	PESO UNID.
BTM106404	25,93	50	0,510

**VÁLVULA H-H 1 1/2" DN40**

REF.	EUROS	UNID. DE EMBALAJE	PESO UNID.
BTM106405	38,53	50	0,758

**VÁLVULA H-H 2" DN50**

REF.	EUROS	UNID. DE EMBALAJE	PESO UNID.
BTM106406	60,66	50	1,227

Revisión A

VÁLVULAS LINEALES PN25 H ADAPTABLES AL SISTEMA ANTIFRAUDE MAGNÉTICO



\* Hasta fin de existencias

VÁLVULA H-H 1" PN25

DISPOSITIVO ANTIRRETORNO	SI	NO	REF.	EUROS	UNID. DE EMBALAJE	PESO UNID.
	<input type="checkbox"/>	<input checked="" type="checkbox"/>	118300-1" (*)	12,84	30	0,368

VÁLVULA H-H 1 1/4" PN25

DISPOSITIVO ANTIRRETORNO	SI	NO	REF.	EUROS	UNID. DE EMBALAJE	PESO UNID.
	<input type="checkbox"/>	<input checked="" type="checkbox"/>	118300-11/4" (*)	19,68	30	0,575

VÁLVULA H-H 1 1/2" PN25

DISPOSITIVO ANTIRRETORNO	SI	NO	REF.	EUROS	UNID. DE EMBALAJE	PESO UNID.
	<input type="checkbox"/>	<input checked="" type="checkbox"/>	118300-11/2" (*)	28,41	20	0,781

VÁLVULA H-H 2" PN25

DISPOSITIVO ANTIRRETORNO	SI	NO	REF.	EUROS	UNID. DE EMBALAJE	PESO UNID.
	<input type="checkbox"/>	<input checked="" type="checkbox"/>	118300-2" (*)	45,03	10	1,323



LLAVE PARA DESBLOQUEO TORNILLO ANTIFRAUDE

REF.	EUROS	UNID. DE EMBALAJE	PESO UNID.
BTR101092	3,05	1	0,021



TAPÓN ANTIFRAUDE

REF.	EUROS	UNID. DE EMBALAJE	PESO UNID.
BTR101090	2,41	1	0,033



LLAVE PARA DESBLOQUEO EXCLUSIVA PARA COMPAÑÍAS DE AGUA

REF.	EUROS	UNID. DE EMBALAJE	PESO UNID.
BTR101091	5,00	1	0,023



TORNILLO ANTIFRAUDE

MODELO	REF.	EUROS	UNID. DE EMBALAJE	PESO UNID.
M4x16	BTR101098	0,51	100	0,002
M5x16	BTR101099	0,74	100	0,002

Revisión A



**SISTEMA ADAPTABLE A TODOS LOS MODELOS DE VÁLVULAS DEL MERCADO**

**VÁLVULA ESTANDAR CON  
DISPOSITIVO DE CIERRE MANUAL**



**VÁLVULA CON ADAPTADOR  
PARA TAPÓN ANTIFRAUDE**



**SISTEMA PATENTADO**

**LLAVE PARA DESBLOQUEO EXCLUSIVO  
PARA COMPAÑÍAS DE AGUAS**



**VÁLVULA CON TAPÓN ANTIFRAUDE  
Y LLAVE MAGNÉTICA PARA EL  
DESBLOQUEO DEL TAPÓN ANTIFRAUDE**

**VÁLVULA CON TAPÓN  
ANTIFRAUDE**



**VÁLVULAS DE BOLA CON SISTEMA ANTIFRAUDE, CON BLOQUEO DE LA VÁLVULA  
MEDIANTE SISTEMA MAGNÉTICO**

EL ÚNICO SISTEMA ANTIFRAUDE A NIVEL MUNDIAL QUE SE PUEDE ADAPTAR A CUALQUIER MODELO DE VÁLVULA DEL MERCADO, MEDIANTE ADAPTADORES PARA CADA MODELO.

LLAVE PARA DESBLOQUEO  
EXCLUSIVO PARA COMPAÑÍAS DE AGUAS



SISTEMA PATENTADO

TAPÓN ANTIFRAUDE



VÁLVULA CON DISPOSITIVO DE TRANSFORMACIÓN DISPONIBLE PARA TODOS LOS MODELOS DE VÁLVULAS DE CUALQUIER FABRICANTE

VÁLVULA CON EL ADAPTADOR INCORPORADO

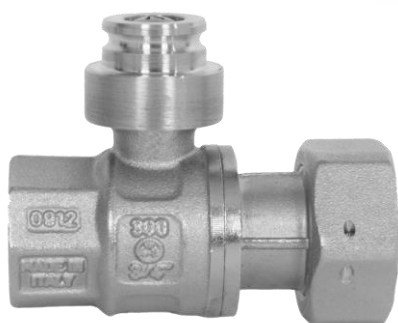

Revisión A

**LLAVE DE DESBLOQUEO EXCLUSIVO PARA COMPAÑÍAS DE AGUAS**

**VÁLVULA ESTANDAR  
MONTADA CON VOLANTE**



**VÁLVULA SIN DISPOSITIVO  
DE TRANSFORMACIÓN**



**SISTEMA PATENTADO**

**VÁLVULA CON DISPOSITIVO DE  
TRANSFORMACIÓN INSTALADO**



**DETALLE DE POSICIONAMIENTO  
DEL DISPOSITIVO DE TRANSFORMACIÓN**

**LLAVE DE DESBLOQUEO EXCLUSIVO  
PARA COMPAÑÍAS DE AGUAS**



**DETALLE DE POSICIONAMIENTO  
DEL TAPÓN ANTIFRAUDE**

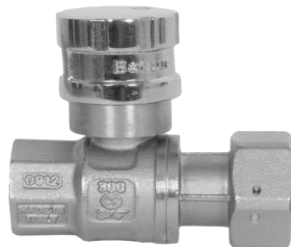

**VÁLVULA MONTADA CON TAPÓN  
ANTIFRAUDE Y LLAVE MAGNETICA PARA  
EL DESBLOQUEO DEL TAPÓN ANTIFRAUDE**

Revisión A

**INSTRUCCIONES PARA EL BLOQUEO Y DESBLOQUEO DE LA VÁLVULA DE ESFERA ANTIFRAUDE DN20 REF. BT101011 Y BT102011****BLOQUEO DEL TAPÓN ANTIFRAUDE REF. BTR101090.**

1. Desmontar el volante de la válvula aflojando el tornillo de cabeza en cruz situado encima de este.
2. Introducir el tapón Antifraude en la parte superior de la válvula hasta que este quede bloqueado.
3. Si el tapón Antifraude se bloquea manualmente fuera de la válvula, habrá que desbloquearlo mediante la llave de condensa **REF. BTR101091** y se procede de la siguiente forma; se sitúa la letra **B** del tapón Antifraude **REF. BTR101090** y la letra **B** de la llave de condensa de manera que coincidan las dos, a continuación se oprime hacia dentro el sistema de bloqueo y al soltar debe quedar desbloqueado el tapón Antifraude.

**Llave de condensa  
Ref. BTR101091****DESBLOQUEO DEL TAPÓN ANTIFRAUDE REF. BTR101090.**

1. Se posiciona la llave de condensa **REF. BTR101091** encima del tapón Antifraude **REF. BTR101090** de manera que coincida la letra **B** de la llave de condensa con la letra **B** del tapón Antifraude, a continuación presionar hacia abajo y el tapón Antifraude quedará desbloqueado.

**Tapón Antifraude  
Ref. BTR101090****INFORMACIÓN TÉCNICA:**

El desbloqueo del tapón Antifraude se consigue a través del campo magnético que genera la llave de condensa, la cual dispone de unos imanes situados estratégicamente en el interior de la llave de condensa, que activa el sistema de bloqueo del tapón para conseguir el desbloqueo de este, siendo imposible poder abrir el sistema de bloqueo de otra forma.

**SISTEMA PATENTADO**

Revisión A

# VÁLVULAS ESFERA

## SERIE BS

Revisión A  
**23/01**

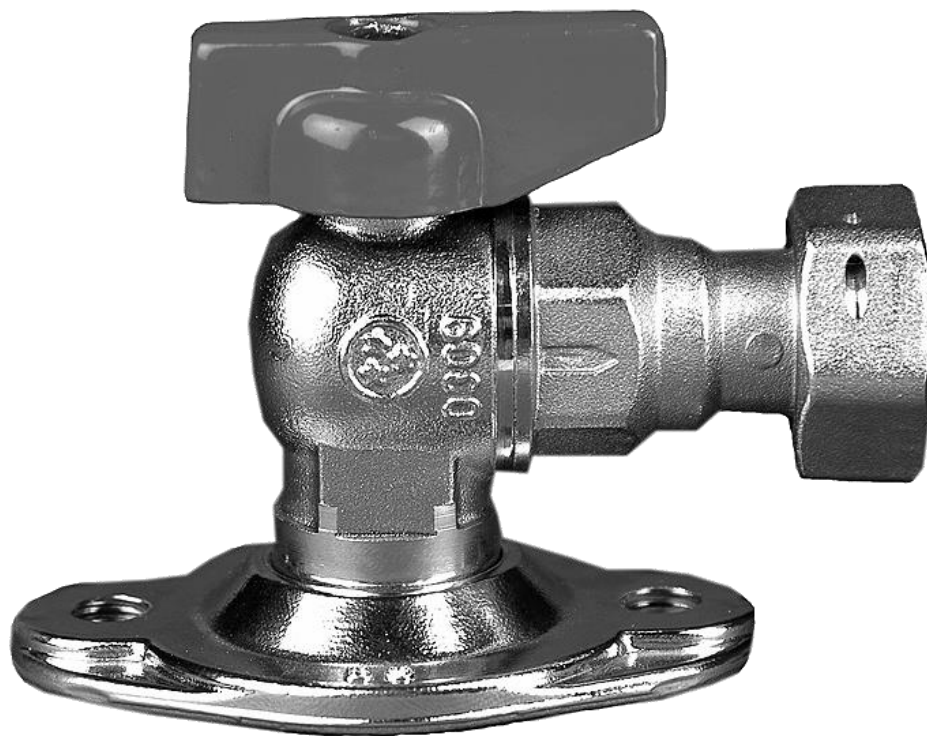

Revisión A

**ÍNDICE**

**PAG. 63-68..... VÁLVULAS SERIE ESFERA**

**PAG. 69-70..... ACCESORIOS VÁLVULAS SERIE ESFERA**

**PAG. 71-72..... VÁLVULAS DE BOLA RECTAS EN PVC**



Revisión A

VÁLVULAS ENTRADA PARA CONTADORES Ø 13, 15 Y 20

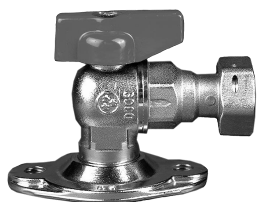

**ENTRADA ORIENTABLE DN 15 RACOR 3/4"-7/8"**

DISPOSITIVO ANTIRRETORNO	SI	NO	REF.	EUROS	UNID. DE EMBALAJE	PESO UNID.
	<input type="checkbox"/>	<input checked="" type="checkbox"/>	111001	19,55	50	0,400



**ENTRADA ORIENTABLE Y ANTIFRAUDE DN 15 RACOR 3/4"-7/8"**

DISPOSITIVO ANTIRRETORNO	SI	NO	REF.	EUROS	UNID. DE EMBALAJE	PESO UNID.
	<input type="checkbox"/>	<input checked="" type="checkbox"/>	111122	24,75	40	0,425



**ENTRADA ORIENTABLE DN 15 RACOR 3/4"-7/8"**

DISPOSITIVO ANTIRRETORNO	SI	NO	REF.	EUROS	UNID. DE EMBALAJE	PESO UNID.
	<input type="checkbox"/>	<input checked="" type="checkbox"/>	111004	19,08	50	0,375

**ENTRADA ORIENTABLE Y ANTIFRAUDE DN 20 RACOR 1"**

DISPOSITIVO ANTIRRETORNO	SI	NO	REF.	EUROS	UNID. DE EMBALAJE	PESO UNID.
	<input type="checkbox"/>	<input checked="" type="checkbox"/>	111044	19,55	40	0,500

Revisión A

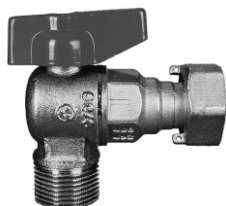
**VÁLVULAS ENTRADA PARA CONTADORES Ø 13, 15 Y 20**

**ENTRADA DN 15 M-3/4" RACOR 3/4"-7/8"**

DISPOSITIVO ANTIRRETORNO	SI	NO	REF.	EUROS	UNID. DE EMBALAJE	PESO UNID.
	<input type="checkbox"/>	<input checked="" type="checkbox"/>	112001	10,53	50	0,230

**ENTRADA DN 15 M-3/4" RACOR 3/4"-7/8"**

DISPOSITIVO ANTIRRETORNO	SI	NO	REF.	EUROS	UNID. DE EMBALAJE	PESO UNID.
	<input type="checkbox"/>	<input checked="" type="checkbox"/>	112002	12,65	50	0,235

**ENTRADA CON DISPOSITIVO ANTIFRAUDE DN 15 M-3/4" RACOR 3/4"-7/8"**

DISPOSITIVO ANTIRRETORNO	SI	NO	REF.	EUROS	UNID. DE EMBALAJE	PESO UNID.
	<input type="checkbox"/>	<input checked="" type="checkbox"/>	111200	18,07	50	0,235

**MACHO 3/4" HEMBRA 1/2" DN 15**

DISPOSITIVO ANTIRRETORNO	SI	NO	REF.	EUROS	UNID. DE EMBALAJE	PESO UNID.
	<input type="checkbox"/>	<input checked="" type="checkbox"/>	115001	5,93	50	0,200

RACORES INCLUIDOS EXCEPTO REF.115001

FILTROS PARA VÁLVULAS ESFERA PÁG. 46

Revisión A



VÁLVULAS ENTRADA PARA CONTADORES Ø 13, 15 Y 20



**ENTRADA DN 15 CON CONEXIÓN A P-E Ø EXT 25 RACOR 3/4"**

DISPOSITIVO ANTIRRETORNO	SI	NO	REF.	EUROS	UNID. DE EMBALAJE	PESO UNID.
	<input type="checkbox"/>	<input checked="" type="checkbox"/>	112003	12,88	50	0,375

\* Hasta fin de existencias



**ENTRADA DN 15 CON DISPOSITIVO ANTIFRAUDE Y CONEXIÓN A P-E Ø EXT 25 RACOR 3/4"**

DISPOSITIVO ANTIRRETORNO	SI	NO	REF.	EUROS	UNID. DE EMBALAJE	PESO UNID.
	<input type="checkbox"/>	<input checked="" type="checkbox"/>	112020	24,65	40	0,235

\* Hasta fin de existencias



**ENTRADA DN 15 H 1/2" RACOR 3/4"**

DISPOSITIVO ANTIRRETORNO	SI	NO	REF.	EUROS	UNID. DE EMBALAJE	PESO UNID.
	<input type="checkbox"/>	<input checked="" type="checkbox"/>	115201	8,57	50	0,150

**ENTRADA DN 20 H 3/4" RACOR 3/4"**

DISPOSITIVO ANTIRRETORNO	SI	NO	REF.	EUROS	UNID. DE EMBALAJE	PESO UNID.
	<input type="checkbox"/>	<input checked="" type="checkbox"/>	115202-3/4"	11,14	50	0,260

**ENTRADA DN 20 H 3/4" RACOR 7/8"**

DISPOSITIVO ANTIRRETORNO	SI	NO	REF.	EUROS	UNID. DE EMBALAJE	PESO UNID.
	<input type="checkbox"/>	<input checked="" type="checkbox"/>	115202-7/8"	11,83	50	0,260

**ENTRADA DN 20 H 3/4" RACOR 1"**

DISPOSITIVO ANTIRRETORNO	SI	NO	REF.	EUROS	UNID. DE EMBALAJE	PESO UNID.
	<input type="checkbox"/>	<input checked="" type="checkbox"/>	115203	13,39	50	0,275

INCLUIDOS RACORES DE CONEXIÓN AL CONTADOR

FILTROS PARA VÁLVULAS ESFERA PÁG. 59

Revisión A

VÁLVULAS ENTRADA PARA CONTADORES Ø 13, 15 Y 20

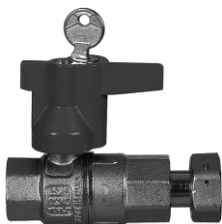

**ENTRADA DN 15 CON DISPOSITIVO ANTIFRAUDE H 1/2" RACOR 3/4"-7/8"**

DISPOSITIVO ANTIRRETORNO	SI	NO	REF.	EUROS	UNID. DE EMBALAJE	PESO UNID.
	<input checked="" type="checkbox"/>	<input type="checkbox"/>	114020	38,06	50	0,155



**ENTRADA DN 15 H 1/2" RACOR 3/4"**

DISPOSITIVO ANTIRRETORNO	SI	NO	REF.	EUROS	UNID. DE EMBALAJE	PESO UNID.
	<input checked="" type="checkbox"/>	<input type="checkbox"/>	116001-3/4"	13,36	50	0,225

**ENTRADA DN 15 H 1/2" RACOR 7/8"**

DISPOSITIVO ANTIRRETORNO	SI	NO	REF.	EUROS	UNID. DE EMBALAJE	PESO UNID.
	<input checked="" type="checkbox"/>	<input type="checkbox"/>	116001-7/8"	14,21	50	0,225



**ENTRADA DN 15 CON RACOR TELESCÓPICO H-1/2" RACOR 3/4"**

DISPOSITIVO ANTIRRETORNO	SI	NO	REF.	EUROS	UNID. DE EMBALAJE	PESO UNID.
	<input type="checkbox"/>	<input checked="" type="checkbox"/>	115301	14,12	50	0,260

**ENTRADA DN 20 CON RACOR TELESCÓPICO H-3/4" RACOR 1"**

DISPOSITIVO ANTIRRETORNO	SI	NO	REF.	EUROS	UNID. DE EMBALAJE	PESO UNID.
	<input type="checkbox"/>	<input checked="" type="checkbox"/>	115302	16,88	30	0,400

\*Hasta fin de existencias

INCLUIDOS RACORES DE CONEXIÓN AL CONTADOR

FILTROS PARA VÁLVULAS ESFERA PÁG. 69

**VÁLVULA PORTASONDAS**



ROSCA GAS	REF.	EUROS	UNID. EMBALAJE	PESO UNID.
3/4" x M10	99000037	12,48	50	0,270

Revisión A

VÁLVULAS SALIDA PARA CONTADORES Ø 13, 15 Y 20



**SALIDA DN 15 CON PURGA Y RACOR 3/4"**

		REF.	EUROS	UNID. DE EMBALAJE	PESO UNID.
<b>DISPOSITIVO ANTIRRETORNO</b>	SI <input checked="" type="checkbox"/> NO <input type="checkbox"/>	113009	12,87	50	0,240



**SALIDA DN 15 CON PURGA Y CONEXIÓN A P-E Ø EXT 25 RACOR 3/4"**

		REF.	EUROS	UNID. DE EMBALAJE	PESO UNID.
<b>DISPOSITIVO ANTIRRETORNO</b>	SI <input checked="" type="checkbox"/> NO <input type="checkbox"/>	113007	19,55	50	0,375

INCLUIDOS RACORES DE CONEXIÓN AL CONTADOR

FILTROS PARA VÁLVULAS ESFERA PÁG. 69



**SALIDA DN 20 CON PURGA H 3/4 - RACOR 3/4"**

		REF.	EUROS	UNID. DE EMBALAJE	PESO UNID.
<b>DISPOSITIVO ANTIRRETORNO</b>	SI <input checked="" type="checkbox"/> NO <input type="checkbox"/>	110003	13,94	50	0,330

INCLUIDOS RACORES DE CONEXIÓN AL CONTADOR

FILTROS PARA VÁLVULAS ESFERA PÁG. 69

Revisión A

VÁLVULAS SALIDA PARA CONTADORES Ø 13, 15 Y 20



**SALIDA DN 15 H-1/2" RACOR 3/4"**

DISPOSITIVO ANTIRRETORNO	SI	NO	REF.	EUROS	UNID. DE EMBALAJE	PESO UNID.
	<input checked="" type="checkbox"/>	<input type="checkbox"/>	117001	10,06	50	0,225

**SALIDA DN 20 H-3/4" RACOR 3/4"**

DISPOSITIVO ANTIRRETORNO	SI	NO	REF.	EUROS	UNID. DE EMBALAJE	PESO UNID.
	<input checked="" type="checkbox"/>	<input type="checkbox"/>	117111	13,35	50	0,415

**SALIDA DN 20 H-3/4" RACOR 1" (\*)**

DISPOSITIVO ANTIRRETORNO	SI	NO	REF.	EUROS	UNID. DE EMBALAJE	PESO UNID.
	<input checked="" type="checkbox"/>	<input type="checkbox"/>	117011	19,19	50	0,425

\*Hasta fin de existencias

INCLUIDOS RACORES DE CONEXIÓN AL CONTADOR

FILTROS PARA VÁLVULAS ESFERA PÁG. 69



Revisión A

ACCESORIOS VÁLVULAS ESFERA



**TUERCA RACOR 3/4" CON JUNTA**

REF.	EUROS	UNID. DE EMBALAJE	PESO UNID.
1031034	2,27	10	0,033

**TUERCA RACOR 7/8" CON JUNTA**

REF.	EUROS	UNID. DE EMBALAJE	PESO UNID.
1031078	2,72	10	0,042



**FILTRO PARA VÁLVULA DE ESFERA DN 15 M-3/4" RACOR 3/4"-7/8"**

REF.	EUROS	UNID. DE EMBALAJE	PESO UNID.
02790001	14,81	15	0,210

**FILTRO PARA VÁLVULA DE ESFERA DN 20 M-1" RACOR 1"**

REF.	EUROS	UNID. DE EMBALAJE	PESO UNID.
02790002	15,09	6	0,250

## ACCESORIOS VÁLVULAS ESFERA

**JUNTA PLANA EPDM 3/4" PARA RACOR VÁLVULA ESFERA DN 15**

REF.	EUROS	UNID. DE EMBALAJE	PESO UNID.
1035111	0,19	25	0,012

**JUNTA PLANA EPDM 7/8" PARA RACOR VÁLVULA ESFERA DN 15**

REF.	EUROS	UNID. DE EMBALAJE	PESO UNID.
1035112	0,23	25	0,014

**JUNTA PLANA EPDM 1" PARA RACOR VÁLVULA ESFERA DN 20**

REF.	EUROS	UNID. DE EMBALAJE	PESO UNID.
1035161	0,27	25	0,015

**JUNTA PLANA EPDM PARA BRIDA ORIENTABLE DN 15**

REF.	EUROS	UNID. DE EMBALAJE	PESO UNID.
1035110	0,50	25	0,018

**CONJUNTO DE ACCESORIOS PARA MONTAJE VÁLVULA ORIENTABLE DN 15 3/4" ESFERA**

REF.	EUROS	UNID. DE EMBALAJE	PESO UNID.
1039996	1,51	10	0,090

**CONJUNTO DE ACCESORIOS PARA MONTAJE VÁLVULA ORIENTABLE DN 15 7/8" ESFERA**

REF.	EUROS	UNID. DE EMBALAJE	PESO UNID.
1039995	1,52	10	0,100

Revisión A

VÁLVULAS DE BOLA RECTAS EN PVC PN10 CON SISTEMA ANTIFRAUDE MAGNÉTICO



H-H 1/2" DN15

REF.	EUROS	UNID. DE EMBALAJE	PESO UNID.
PVC10001	5,48	100	0,126

Opcional con tornillo antifraude



H-H 1/2" DN15 CON TAPÓN DE BLOQUEO MAGNÉTICO

REF.	EUROS	UNID. DE EMBALAJE	PESO UNID.
PVC10101	7,61	100	0,126



M-H 1/2"

REF.	EUROS	UNID. DE EMBALAJE	PESO UNID.
PVC10002	7,51	80	0,168

Opcional con tornillo antifraude



H 1/2" RACOR DE NYLON 3/4" – 7/8"

REF.	EUROS	UNID. DE EMBALAJE	PESO UNID.
PVC10003	6,62	80	0,150

Opcional con tornillo antifraude



H 1/2" RACOR DE NYLON 3/4" – 7/8" CON TAPÓN DE BLOQUEO MAGNÉTICO

REF.	EUROS	UNID. DE EMBALAJE	PESO UNID.
PVC10103	8,76	80	0,150

DISPUESTAS CON BLOQUEO DE VOLANTE PARA POSICIÓN DE MÍNIMO VITAL CON SISTEMA DE SEGURIDAD

TODAS LAS VÁLVULAS DISPONEN DE ROSCA CON INSERTO METÁLICO

\*\*\*PARA VÁLVULAS CON TORNILLO ANTIFRAUDE SUMAR LA REF. BTR101098 DE LA PÁGINA 56\*\*\*

VÁLVULAS DE BOLA RECTAS EN PVC PN10 CON SISTEMA ANTIFRAUDE MAGNÉTICO



**H 1/2" RACOR TELESCÓPICO 3/4" DN15**

REF.	EUROS	UNID. DE EMBALAJE	PESO UNID.
PVC10006	5,61	80	0,152

Opcional con tornillo antifraude



**H 1/2" RACOR TELESCÓPICO 3/4" DN15 CON TAPÓN DE BLOQUEO MAGNÉTICO**

REF.	EUROS	UNID. DE EMBALAJE	PESO UNID.
PVC10106	7,75	80	0,152



**M 1/2" P.E. DN16-20**

REF.	EUROS	UNID. DE EMBALAJE	PESO UNID.
PVC10004	7,61	80	0,194

Opcional con tornillo antifraude



**H 1/2" P.E. DN16-20**

REF.	EUROS	UNID. DE EMBALAJE	PESO UNID.
PVC10005	5,50	80	0,150

Opcional con tornillo antifraude



**H 1/2" P.E. DN16-20 RACOR DE NYLON 3/4" - 7/8"**

REF.	EUROS	UNID. DE EMBALAJE	PESO UNID.
PVC10007	6,64	80	0,174

Opcional con tornillo antifraude

\*\*\*PARA VÁLVULAS CON TORNILLO ANTIFRAUDE SUMAR LA REF. BTR101098 DE LA PÁGINA 56\*\*\*

Revisión A



# ALOJAMIENTO CONTADORES

Revisión A

**23/01**

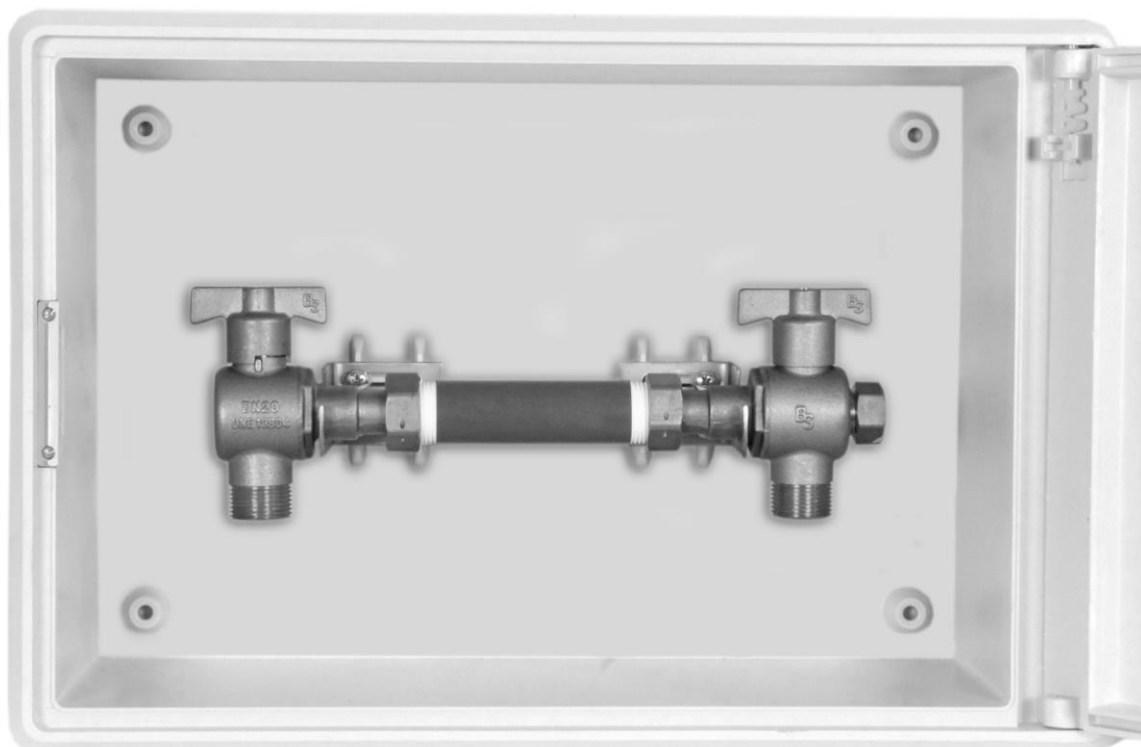

Revisión A

**ÍNDICE**

PAG. 75.....	ARMARIOS PARA CONTADORES DOMICILIARIOS
PAG. 76-77.....	ARMARIOS MONTADOS CON VÁLVULAS
PAG. 78.....	ARMARIOS ESPECIALES PARA CONTADORES
PAG. 79.....	ALOJAMIENTO PARA CONTADORES DE AGUA PPR
PAG. 80.....	KIT DE CONEXIÓN PARA CAJA DE SUELO
PAG. 81.....	SISTEMAS DE CORTE A DISTANCIA DE SUMINISTROS DE AGUA
PAG. 82.....	TAPÓN ANTIFRAUDE
PAG. 83.....	PUERTAS Y REGISTROS ALUMINIO
PAG. 84-86.....	ACCESORIOS ARMARIOS
PAG. 87-89.....	RACORES LATÓN PARA P.E.
PAG. 90.....	REDUCTORES DE PRESIÓN
PAG. 91.....	FILTROS
PAG. 92.....	MANÓMETROS

Revisión A

**ALOJAMIENTO PARA CONTADORES AGUA**



**PUERTA CON MARCO DE POLIÉSTER SIN MIRILLA 292x390**

REF.	EUROS	UNID. DE EMBALAJE	PESO UNID.
530013 (*)	33,67	1	0,615

**PUERTA CON MARCO DE POLIÉSTER CON MIRILLA 292x390**

REF.	EUROS	UNID. DE EMBALAJE	PESO UNID.
530014 (*)	36,20	1	0,615

\*Hasta fin de existencias



**PUERTA CON MARCO DE POLIÉSTER SIN MIRILLA 346x450**

REF.	EUROS	UNID. DE EMBALAJE	PESO UNID.
530001	45,13	4	1,300

**PUERTA CON MARCO DE POLIÉSTER CON MIRILLA 346x450**

REF.	EUROS	UNID. DE EMBALAJE	PESO UNID.
530002	48,07	4	1,300



**ARMARIO DE POLIÉSTER PARA CONTADOR 312x428x190 SIN MIRILLA**

REF.	EUROS	UNID. DE EMBALAJE	PESO UNID.
530101	55,17	1	3,000

**ARMARIO DE POLIÉSTER PARA CONTADOR 312x428x190 CON MIRILLA**

REF.	EUROS	UNID. DE EMBALAJE	PESO UNID.
530103	57,38	1	3,000

**ARMARIO DE POLIÉSTER 312x428x190 SIN MIRILLA Y CON CERRADURA METÁLICA**

REF.	EUROS	UNID. DE EMBALAJE	PESO UNID.
530116	56,61	1	3,000

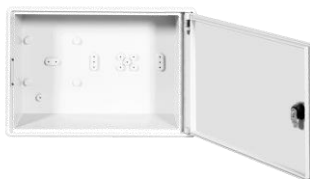

**ARMARIO DE POLIÉSTER PARA CONTADOR 312x428x120 SIN MIRILLA**

REF.	EUROS	UNID. DE EMBALAJE	PESO UNID.
530211	52,53	1	2,400

**ARMARIO DE POLIÉSTER PARA CONTADOR 312x428x120 CON MIRILLA**

REF.	EUROS	UNID. DE EMBALAJE	PESO UNID.
530207	55,14	1	2,400

PARA ARMARIOS CON CERRADURA METÁLICA CONSULTAR PRECIOS

**CON SISTEMA CANDADO**



**ARMARIO DE POLIÉSTER PARA CONTADOR 312x428x120 Y 190 CON MIRILLA**

REF.	EUROS	UNID. DE EMBALAJE	PESO UNID.
530206	66,30	1	2,400

**ARMARIO DE POLIÉSTER PARA CONTADOR 312x428x120 Y 190 SIN MIRILLA**

REF.	EUROS	UNID. DE EMBALAJE	PESO UNID.
530213	65,16	1	2,400

Revisión A

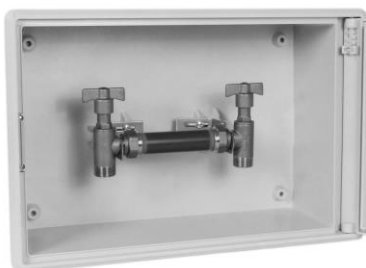
**ARMARIOS POLIÉSTER EQUIPADOS CON VÁLVULAS BS**

**ARMARIO POLIÉSTER 312x428x120 S/M MONTADO CON ANCLAJES A/INOX.**
**VÁLVULA ENTRADA-SALIDA DN 13-15 BS Y CAÑO LIBRE**

REF.	EUROS	UNID. DE EMBALAJE	PESO UNID.
535154	79,32	1	3,700

**ARMARIO POLIÉSTER 312x428x120 S/M MONTADO CON ANCLAJES A/INOX.**
**VÁLVULA ENTRADA-SALIDA DN 20 BS Y CAÑO LIBRE**

REF.	EUROS	UNID. DE EMBALAJE	PESO UNID.
535155	100,55	1	3,900

**ARMARIO POLIÉSTER 312x428x120 S/M MONTADO CON ANCLAJES A/INOX.**
**VÁLVULA ENTRADA-SALIDA DN 13-15 P-E BS Y CAÑO LIBRE**

REF.	EUROS	UNID. DE EMBALAJE	PESO UNID.
535156	91,33	1	4,000

**ARMARIO POLIÉSTER 312x428x120 S/M MONTADO CON ANCLAJES A/INOX.**
**VÁLVULA ENTRADA-SALIDA DN 20 P-E BS Y CAÑO LIBRE**

REF.	EUROS	UNID. DE EMBALAJE	PESO UNID.
535157	111,05	1	4,100

PARA OTRAS COMBINACIONES CONSULTAR

Revisión A

**ARMARIOS POLIÉSTER EQUIPADOS CON VÁLVULAS ESFERA**

**ARMARIO POLIÉSTER 312x428x120 S/M MONTADO CON ANCLAJES A/INOX.**
**VÁLVULA ENTRADA-SALIDA DN 13-15 ESFERA Y CAÑO LIBRE**

REF.	EUROS	UNID. DE EMBALAJE	PESO UNID.
535150	77,11	1	3,600

**ARMARIO POLIÉSTER 312x428x120 S/M MONTADO CON ANCLAJES A/INOX.**
**VÁLVULA ENTRADA-SALIDA DN 20 ESFERA Y CAÑO LIBRE**

REF.	EUROS	UNID. DE EMBALAJE	PESO UNID.
535151	96,81	1	3,900

**ARMARIO POLIÉSTER 312x428x120 S/M MONTADO CON ANCLAJES A/INOX.**
**VÁLVULA ENTRADA-SALIDA DN 13-15 P-E ESFERA Y CAÑO LIBRE**

REF.	EUROS	UNID. DE EMBALAJE	PESO UNID.
535152	93,75	1	4,000

**ARMARIO POLIÉSTER 312x428x120 S/M MONTADO CON ANCLAJES A/INOX.**
**VÁLVULA ENTRADA-SALIDA DN 20 P-E ESFERA Y CAÑO LIBRE**

REF.	EUROS	UNID. DE EMBALAJE	PESO UNID.
535153	111,77	1	4,150

PARA OTRAS COMBINACIONES CONSULTAR

Revisión A

**ALOJAMIENTO PARA CONTADORES DE AGUA**



**ARMARIO DE HORMIGÓN PARA ACOMETIDA INDIVIDUAL  
CON PUERTA DE ALUMINIO 250x350**

REF.	EUROS	UNID. DE EMBALAJE	PESO UNID.
520002	194,77	1	50,000

**ARMARIO DE HORMIGÓN PARA ACOMETIDA INDIVIDUAL  
CON PUERTA DE ALUMINIO 290x390**

REF.	EUROS	UNID. DE EMBALAJE	PESO UNID.
520003	197,89	1	50,000

**ARMARIO DE HORMIGÓN PARA ACOMETIDA INDIVIDUAL  
CON PUERTA DE POLIÉSTER 292x390**

REF.	EUROS	UNID. DE EMBALAJE	PESO UNID.
520004	206,04	1	50,000

**ARMARIO DE HORMIGÓN PARA ACOMETIDA INDIVIDUAL  
CON PUERTA DE POLIÉSTER 292x390 CON MIRILLA**

REF.	EUROS	UNID. DE EMBALAJE	PESO UNID.
520015	209,36	1	50,000

EQUIPAMIENTO INTERIOR NO INCLUIDO

Revisión A



**ARMARIO DE HORMIGÓN PARA BATERÍA DE CONTADORES  
DE 2 SERVICIOS CON PUERTA DE ALUMINIO 400x420**

REF.	EUROS	UNID. DE EMBALAJE	PESO UNID.
520101	244,42	1	49,000

**ARMARIO DE HORMIGÓN PARA BATERÍA DE CONTADORES  
DE 3 SERVICIOS CON PUERTA DE ALUMINIO 520x300**

REF.	EUROS	UNID. DE EMBALAJE	PESO UNID.
520102	639,39	1	47,000

EQUIPAMIENTO INTERIOR NO INCLUIDO



**ARMARIO DE POLIÉSTER 530x530X230**

REF.	EUROS	UNID. DE EMBALAJE	PESO UNID.
530102	90,59	1	4,800

**ARMARIO DE POLIÉSTER 530x700X230**

REF.	EUROS	UNID. DE EMBALAJE	PESO UNID.
530109	109,16	1	14,300

**ARMARIO DE POLIÉSTER 750x750X300**

REF.	EUROS	UNID. DE EMBALAJE	PESO UNID.
530106	488,52	1	18,600

**ARMARIO DE POLIÉSTER 1000x750X300**

REF.	EUROS	UNID. DE EMBALAJE	PESO UNID.
530110	543,25	1	21,200

**ALOJAMIENTO PARA CONTADORES DE AGUA**



**CAJA DE SUELO EN PPR 329x162x160**

REF.	EUROS	UNID. DE EMBALAJE	PESO UNID.
APM542003	28,49	1	0,800

CONTADOR Y KIT DE CONEXIÓN NO INCLUIDOS. ANCLAJES INCLUIDOS



**CAJA DE SUELO EN PPR CON DOS COMPARTIMENTOS 372x224x175 TAPAS POLIPROPILENO CON MIRILLA**

REF.	EUROS	UNID. DE EMBALAJE	PESO UNID.
APM542002	36,29	1	1,000

PARA LLAVE DE APERTURA VER PÁGINA 73

CONTADOR Y KIT DE CONEXIÓN NO INCLUIDOS



**CAJA DE SUELO DE FUNDICIÓN DÚCTIL CON KIT DE CONEXIÓN DE ENTRADA Y SALIDA PARA CONTADOR DE 110 LONG.**

REF.	EUROS	UNID. DE EMBALAJE	PESO UNID.
CTR00110	64,76	1	6,888

**CAJA DE SUELO DE FUNDICIÓN DÚCTIL CON KIT DE CONEXIÓN DE ENTRADA Y SALIDA PARA CONTADOR DE 115 LONG.**

REF.	EUROS	UNID. DE EMBALAJE	PESO UNID.
CTR00115	76,26	1	6,920

**ARQUETA DE FUNDICIÓN VACÍA**

REF.	EUROS	UNID. DE EMBALAJE	PESO UNID.
CTR00001	34,75	1	6,040

\*Hasta fin de existencias

Revisión A

**KIT DE CONEXIÓN PARA CAJA DE SUELO**



**KIT DE CONEXIÓN ENTRADA Y SALIDA CON VÁLVULAS DE PVC 1/2"**

REF.	CONEXIÓN	EUROS	UNID. DE EMBALAJE	PESO UNID.
PVC10003-K	PPR	10,30	1	0,150
LAT10003-K	LATÓN	19,28	1	0,227

KIT DE CONEXIÓN PARA REF.APM542003 – APM542002



**KIT DE CONEXIÓN ENTRADA Y SALIDA CON VÁLVULAS DE LATÓN 1/2"**

REF.	CONEXIÓN	EUROS	UNID. DE EMBALAJE	PESO UNID.
PVC10006-K	PPR	29,82	1	0,152
LAT10006-K	LATÓN	39,51	1	0,279

KIT DE CONEXIÓN PARA REF.APM542003 – APM542002  
VÁLVULA ENTRADA CON SISTEMA ANTIFRAUDE MAGNÉTICO



**KIT DE CONEXIÓN ENTRADA CON CUADRADILLO 30x30 Y SALIDA CON VÁLVULAS DE LATÓN 1/2"**

REF.	CONEXIÓN	EUROS	UNID. DE EMBALAJE	PESO UNID.
LAT10007-K	LATÓN	33,20	1	0,289

KIT DE CONEXIÓN PARA REF.APM542001  
VÁLVULA ENTRADA CON SISTEMA ANTIFRAUDE MAGNÉTICO



**KIT DE CONEXIÓN ENTRADA Y SALIDA DN 15 3/4"**

REF.	EUROS	UNID. DE EMBALAJE	PESO UNID.
CTRKIT01	37,07	2	0,310

\*Hasta fin de existencias

KIT VÁLVULAS PARA REF.CTR00001

**TAPA DE REGISTRO POLIPROPILENO 18 x 18 PARA SISTEMA SUBTERRÁNEO**



REF.	EUROS	UNID. EMBALAJE	PESO UNID.
00800018	6,79	1	0,250



### SISTEMA INALÁMBRICO DE CORTE A DISTANCIA DE SUMINISTRO DE AGUA



REF.	EUROS	UNID. EMBALAJE	PESO UNID.
APM552001	772,68	1	4,800

### MANDO A DISTANCIA DEL SISTEMA INALÁMBRICO



REF.	EUROS	UNID. EMBALAJE	PESO UNID.
APM552002	901,80	1	0,756

### SISTEMA DE CORTE ANTIFRAUDE MAGNÉTICO



MEDIDA	REF.	EUROS	UNID. DE EMBALAJE	PESO UNID.
1/2"	APM552003	46,69	1	1,074
3/4"	APM552013	51,81	1	1,178
1"	APM552023	66,11	1	1,421
1 1/4"	APM552033	80,91	1	1,764
1 1/2"	APM552043	103,22	1	2,437
2"	APM552053	129,84	1	3,263

### LLAVE DE ALLEN 8mm LONG.188x43



MEDIDA	REF.	EUROS	UNID. DE EMBALAJE	PESO UNID.
8mm	10034360	6,04	1	0.096

### LLAVE DEL SISTEMA DE CORTE ANTIFRAUDE MAGNÉTICO



MEDIDA	REF.	EUROS	UNID. DE EMBALAJE	PESO UNID.
1/2"	APM552103	63,67	1	0,613
3/4" - 1" - 1 1/4"	APM552113	65,80	1	0,643
1 1/2" - 2"	APM552143	73,66	1	0,683

### ALARGADERA LLAVE DEL SISTEMA DE CORTE ANTIFRAUDE MAGNÉTICO



REF.	EUROS	UNID. DE EMBALAJE	PESO UNID.
APM552203	51,24	1	0,542

**TAPÓN ANTIFRAUDE HEMBRA CON FUNDA GIRATORIA ROSCA IZQUIERDA**

MEDIDA	REF.	EUROS	UNID. DE EMBALAJE	PESO UNID.
21,8	SAAB0001	5,99	1	0,147
3/4"	SAAB0002	6,03	1	0,151
1"	SAAB0003	9,23	1	0,248

COMPLETAR PIDIENDO TAPÓN GIRATORIO. VEASE PÁGINA 56 REF. BTR101090

**TAPÓN ANTIFRAUDE MACHO ROSCA DERECHA**

MEDIDA	REF.	EUROS	UNID. DE EMBALAJE	PESO UNID.
1/2"	AV000017	3,43	1	0,081
3/4"	AV000016	3,82	1	0,098
7/8"	AV000018	4,17	1	0,112
1"	AV000019	5,13	1	0,143

COMPLETAR PIDIENDO TAPÓN GIRATORIO. VEASE PÁGINA 56 REF. BTR101090

Revisión A

**PUERTAS Y REGISTROS DE ALUMINIO**

PUERTA CON MARCO	REF.	EUROS	UNID. EMBALAJE	PESO UNID.
ALUMINIO				
150x200	500001	16,58	10	0,850
200x320	500002	19,51	10	1,300
250x350	500003	23,05	10	1,500
250x500	500004	38,42	10	2,100
300x500	500009	36,75	10	1,700
290x390	500005	25,43	10	1,800
220x350	500006	17,58	10	1,400
400x420	500007	60,53	5	3,500
285x385	500010	35,09	10	1,400

MOD. CÓRDOBA



REGISTRO DE ALUMINIO	REF.	EUROS	UNID. EMBALAJE	PESO UNID.
200x200	801020	13,76	10	1,700
300x300	801030	34,21	10	1,900
400x400	801040	56,09	10	3,200



REGISTRO DE ALUMINIO PARA LLAVE DE CORTE	REF.	EUROS	UNID. EMBALAJE	PESO UNID.
200x200	502002	11,00	10	0,800



SUMIDERO ALUMINIO	REF.	EUROS	UNID. EMBALAJE	PESO UNID.
150x150	800015	10,09	10	0,600
200x200	800020	15,14	10	0,750
250x250	800025	21,13	10	1,050
300x300	800030	29,36	10	2,030
400x400	800040	53,87	10	2,800

Revisión A

### ACCESORIOS PARA ARMARIOS

#### CERRADURA METÁLICA PARA PUERTA DE ALUMINIO

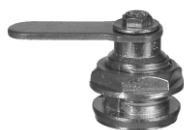

MODELO	REF.	EUROS	UNID. DE EMBALAJE	PESO UNID.
CUADRADILLO HEMBRA	500204	4,58	1	0,030
CUADRADILLO MACHO	500214	4,58	1	0,030
TRIANGULAR MACHO	500205	2,61	1	0,030
ALLEN	500220	4,58	1	0,030

#### LLAVE METÁLICA PARA PUERTA DE ALUMINIO

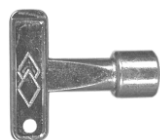

MODELO	REF.	EUROS	UNID. DE EMBALAJE	PESO UNID.
CUADRADILLO MACHO	500199	1,91	1	0,012
CUADRADILLO HEMBRA	500227	1,91	1	0,012
TRIANGULAR HEMBRA	500228	1,91	1	0,012
ALLEN	500223	1,91	1	0,012

#### CERRADURA TRIANGULAR

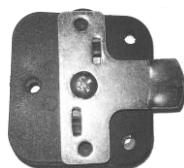

REF.	EUROS	UNID. DE EMBALAJE	PESO UNID.
502015	4,21	1	0,025

#### CERRADURA DE CUADRADILLO

REF.	EUROS	UNID. DE EMBALAJE	PESO UNID.
502012	4,21	1	0,025

#### LLAVE TRIANGULAR



REF.	EUROS	UNID. DE EMBALAJE	PESO UNID.
500201	1,32	1	0,008

#### LLAVE METÁLICA PARA ARQUETAS REF.APM542003-APM542001-APM542002



REF.	EUROS	UNID. DE EMBALAJE	PESO UNID.
00502113	2,85	1	0,056

Revisión A

ACCESORIOS PARA ARMARIOS



HASTA FIN DE EXISTENCIAS

**CERRADURA METÁLICA TRIANGULAR 8mm**

REF.	EUROS	UNID. DE EMBALAJE	PESO UNID.
502019	9,94	1	0,155

**CERRADURA METÁLICA DE CUADRADILLO 8mm**

REF.	EUROS	UNID. DE EMBALAJE	PESO UNID.
502018	9,94	1	0,155



**JUEGO ANCLAJES ACERO INOXIDABLE PARA ARMARIO DE POLIÉSTER**

REF.	EUROS	UNID. DE EMBALAJE	PESO UNID.
539903	5,89	1	0,26



**AISLAMIENTO TÉRMICO PARA PUERTA DE POLIÉSTER 312x428**

REF.	EUROS	UNID. DE EMBALAJE	PESO UNID.
997000	7,15	1	0,010

**AISLAMIENTO TÉRMICO PARA CUBA 312x428x190**

REF.	EUROS	UNID. DE EMBALAJE	PESO UNID.
997020	7,15	1	0,030

Revisión A

**ACCESORIOS PARA ARMARIOS**

**COLECTOR ROSCADO DE 1" CON 2 SALIDAS PARA ARMARIO DE HORMIGÓN**

REF.	EUROS	UNID. DE EMBALAJE	PESO UNID.
180001	45,25	1	1,300

**COLECTOR ROSCADO DE 1" CON 3 SALIDAS PARA ARMARIO DE HORMIGÓN**

REF.	EUROS	UNID. DE EMBALAJE	PESO UNID.
180002	51,88	1	1,700

**CODO EMBRIDADO DOBLE BRIDA 2" GALVANIZADO**

REF.	EUROS	UNID. DE EMBALAJE	PESO UNID.
180003	70,19	1	6,000

**CODO EMBRIDADO DOBLE BRIDA 2 1/2" GALVANIZADO**

REF.	EUROS	UNID. DE EMBALAJE	PESO UNID.
180004	87,52	1	7,200

**CODO EMBRIDADO DOBLE BRIDA 3" GALVANIZADO**

REF.	EUROS	UNID. DE EMBALAJE	PESO UNID.
180005	100,22	1	9,300

**CODO EMBRIDADO DOBLE BRIDA 4" GALVANIZADO**

REF.	EUROS	UNID. DE EMBALAJE	PESO UNID.
180006	114,13	1	11,000

Revisión A

### RACORES DE LATÓN PARA P-E

#### MANGUITO



MEDIDAS	REF.	EUROS	UNID. EMBALAJE	PESO UNID.
20x20	770001	10,11	10	0,150
25x25	770002	12,16	10	0,200
32x32	770003	18,51	10	0,320
40x40	770004	35,97	10	0,450
50x50	770005	53,11	10	0,630
63x63	770006	74,84	5	0,920
75x75	770007	113,61	1	2,350

#### RACOR ROSCA MACHO



MEDIDAS	REF.	EUROS	UNID. EMBALAJE	PESO UNID.
20x1/2"	770008	6,08	10	0,090
25x3/4"	770009	7,69	10	0,130
32x1"	770010	11,00	10	0,200
40x1 1/4"	770011	21,45	10	0,300
50x1 1/2"	770012	28,38	10	0,400
63x2"	770013	42,05	5	0,540

#### RACOR ROSCA HEMBRA



MEDIDAS	REF.	EUROS	UNID. EMBALAJE	PESO UNID.
20x1/2"	770015	5,94	10	0,090
25x3/4"	770016	7,51	10	0,130
32x1"	770017	11,20	10	0,190
40x1 1/4"	770018	19,57	10	0,295
50x1 1/2"	770019	29,44	10	0,390
63x2"	770020	41,43	5	0,530

Revisión A

### RACORES DE LATÓN PARA P-E

#### CODO DOS BOCAS IGUALES



MEDIDAS	REF.	EUROS	UNID. EMBALAJE	PESO UNID.
20x20	770022	12,95	10	0,170
25x25	770023	14,82	10	0,260
32x32	770024	23,40	10	0,360
40x40	770025	43,38	10	0,630
50x50	770026	60,18	10	0,850
63x63	770027	85,06	5	1,300

#### "T" MIXTA



MEDIDAS	REF.	EUROS	UNID. EMBALAJE	PESO UNID.
20x1/2"	770047	13,63	10	0,180
25x3/4"	770048	16,74	10	0,260
32x1"	770049	25,86	10	0,390
40x1 1/4"	770050	49,12	10	0,670
50x1 1/2"	770051	71,97	5	0,980
63x2"	770052	94,30	5	1,300
75x2 1/2"	770053	129,51	1	3,400

#### RACOR CODO MACHO



MEDIDAS	REF.	EUROS	UNID. EMBALAJE	PESO UNID.
20x1/2"	770028	10,04	10	0,110
25x3/4"	770029	11,75	10	0,150
32x1"	770030	17,66	10	0,255
40x1 1/4"	770031	32,28	10	0,430
50x1 1/2"	770032	46,79	10	0,540
63x2"	770033	68,41	5	0,985

Revisión A



### RACORES DE LATÓN PARA P-E

#### RACOR CODO HEMBRA



MEDIDAS	REF.	EUROS	UNID. EMBALAJE	PESO UNID.
20x1/2"	770034	9,91	10	0,120
25x3/4"	770035	11,72	10	0,170
32x1"	770036	17,80	10	0,230
40x1 1/4"	770037	32,58	10	0,360
50x1 1/2"	770038	44,10	10	0,640
63x2"	770039	72,75	5	1,050

#### "T" TRES BOCAS IGUALES



MEDIDAS	REF.	EUROS	UNID. EMBALAJE	PESO UNID.
20x20x20	770040	18,07	10	0,220
25x25x25	770041	20,90	10	0,305
32x32x32	770042	31,08	10	0,487
40x40x40	770043	58,34	10	0,850
50x50x50	770044	84,98	10	1,050
63x63x63	770045	126,13	5	1,530
75x75x75	770046	173,85	1	4,900

#### CODO PLACA



MEDIDAS	REF.	EUROS	UNID. EMBALAJE	PESO UNID.
1/2"x20	770060	12,67	10	0,180
3/4"x25	770061	14,58	10	0,260

#### MANGUITO REPARACIÓN



MEDIDAS	REF.	EUROS	UNID. EMBALAJE	PESO UNID.
20x20	770062	17,83	10	0,290
25x25	770063	21,45	10	0,400
32x32	770064	31,08	10	0,580
40x40	770065	49,53	10	0,765

Revisión A

## REDUCTORES DE PRESIÓN

### REDUCTOR DE PRESIÓN SERIE R3



PN	PULGADAS	REF.	EUROS	UNID. EMBALAJE	PESO UNID.
PN 15	1/2"	780116	17,30	50	0,350
PN 15	3/4"	780117	18,13	50	0,390

### REDUCTOR DE PRESIÓN A PISTÓN PN25 ASIENTO A/INOX Y TOMA DE MANÓMETRO



PN	PULGADAS	REF.	EUROS	UNID. EMBALAJE	PESO UNID.
PN 25	1/2"	780001	29,51	1	1,360
PN 25	3/4"	780002	42,62	1	2,255
PN 25	1"	780003	50,77	1	3,265
PN 25	1 1/4"	780004	93,80	1	5,090
PN 25	1 1/2"	780005	110,00	1	9,120
PN 25	2"	780006	167,91	1	1,170

### REDUCTOR DE PRESIÓN PN40 CON CÁMARA DE COMPENSACIÓN Y TOMA DE MANÓMETRO



PN	PULGADAS	REF.	EUROS	UNID. EMBALAJE	PESO UNID.
PN 40	2"	780012	644,85	1	11,000
PN 40	2 1/2"	780013	1.480,00	1	13,000
PN 40	3"	780014	1.960,84	1	17,000
PN 40	4"	780015	4.759,31	1	25,000

Revisión A

**FILTROS DE LATÓN**
**FILTRO PARA RECOGIDA DE IMPUREZAS**

PN	PULGADAS	REF.	EUROS	UNID. EMBALAJE	PESO UNID.
PN 16 Precintable	1/2"	790001	5,17	10	0,115
PN 16	3/4"	790002	6,82	10	0,126
PN 16	1"	790003	9,29	10	0,320
PN 16	1 1/4"	790004	18,95	5	0,515
PN 16	1 1/2"	790005	24,68	5	0,665
PN 16	2"	790006	52,53	2	1,195

**FILTRO AUTOLIMPIANTE PARA AGUA MALLA ACERO INOX. 100 MICRAS**

PN	PULGADAS	REF.	EUROS	UNID. EMBALAJE	PESO UNID.
PN 25	3/4"	790010	81,68	15	1,475
PN 25	1"	790011	98,17	10	1,779
PN 25	1 1/4"	790012	98,41	10	1,779
PN 25	1 1/2"	790013	120,43	5	2,941
PN 25	2"	790014	120,40	5	2,941

Revisión A

**MANÓMETROS**

**MANÓMETRO 0-16 BAR Ø 63**

PULGADAS	REF.	EUROS	UNID. DE EMBALAJE	PESO UNID.
1/4"	790015	6,11	1	0,063

**MANÓMETRO 0-25 BAR Ø 63**

PULGADAS	REF.	EUROS	UNID. DE EMBALAJE	PESO UNID.
1/4"	790016	6,11	1	0,063

**MANÓMETRO DE GLICERINA 0-6**

PULGADAS	REF.	EUROS	UNID. DE EMBALAJE	PESO UNID.
1/4"	790018	12,95	1	0,213

**MANÓMETRO DE GLICERINA 0-10**

PULGADAS	REF.	EUROS	UNID. DE EMBALAJE	PESO UNID.
1/4"	790019	12,95	1	0,220

Revisión A

# CONTADORES

Revisión A

**23/01**



REVISION A

**ÍNDICE**

**PAG. 95-97..... CONTADORES USO DOMÉSTICO**

**PAG. 98..... CONJUNTOS MONTADOS**

**PAG. 99-100..... CONTADORES DE CHORRO MÚLTIPLE Y VOLUMÉTRICOS**

**PAG. 101..... CONTADORES WOLTMAN**

**PAG. 102-106..... ACCESORIOS PARA CONTADOR**

Revisión A

**MOD. SJ-SDC PLUS DN15-20 CONTADOR CHORRO ÚNICO R100 CUERPO LATÓN CON PREDISPOSICIÓN HOMOLOGADO**



MODELO	30°C/90°C	DIÁMETRO	LONGITUD	REF.	EUROS	UD.EMBALAJE	PESO UNID.
SJ-SDC-PLUS	A/F	1/2" 13mm	115 mm	NW680111	27,74	20	0,460
SJ-SDC-PLUS	A/F	1/2" 15mm	115 mm	NW680110	26,33	20	0,430
SJ-SDC-PLUS	A/C	1/2" 15mm	115 mm	NW640007	30,82	20	0,430
SJ-SDC-PLUS	A/F	3/4" 20mm	130 mm	NW680112	37,84	20	0,540
SJ-SDC-PLUS	A/C	3/4" 20mm	130 mm	NW640006	38,74	20	0,540

VERIFICACIÓN DE FÁBRICA Y RACORES INCLUIDOS

**MOD. SJ-SDC-PLUS DN15-20 CONTADOR CHORRO ÚNICO R160 CUERPO LATÓN CON PRE-DISPOSICIÓN HOMOLOGADO**



MODELO	30°C	DIÁMETRO	LONGITUD	REF.	EUROS	UD.EMBALAJE	PESO UNID.
SJ-SDC-PLUS	A/F	1/2" 13mm	115 mm	NW680115	30,13	20	0.460
SJ-SDC-PLUS	A/F	1/2" 15mm	115 mm	NW680008	28,80	20	0.430
SJ-SDC-PLUS	A/F	3/4" 20mm	130 mm	NW680309	38,84	20	0.540

VERIFICACIÓN DE FÁBRICA Y RACORES INCLUIDOS

Revisión A

**MOD. SJ-SDC-D3 DN15 CONTADOR CHORRO ÚNICO R100 CUERPO COMPOSITE CON PREDISPOSICIÓN HOMOLOGADO**



MODELO	30°C	DIÁMETRO	LONGITUD	REF.	EUROS	UD. EMBALAJE	PESO UNID.
SJ-SDC	A/F	1/2" 15mm	115 mm	NW680101	23,96	20	0,425

VERIFICACIÓN DE FÁBRICA Y RACORES INCLUIDOS

**MOD. SJ-SDC-PLUS DN15 CONTADOR CHORRO ÚNICO R160 CUERPO COMPOSITE CON PRE-DISPOSICIÓN HOMOLOGADO**



MODELO	30°C	DIÁMETRO	LONGITUD	REF.	EUROS	UD. EMBALAJE	PESO UNID.
SJ-SDC-PLUS	A/F	1/2" 15mm	115 mm	NW680003	24,95	20	0,475

VERIFICACIÓN DE FÁBRICA Y RACORES INCLUIDOS

**MOD. LEXUS-LXSG CONTADOR 8 RODILLOS ESFERA SECA R80 NO HOMOLOGADO**



MODELO	30°C / 90°C	DIÁMETRO	LONGITUD	REF.	EUROS	UNID. EMBALAJE	PESO UNID.
LXSG8R	A/F	1/2" 15mm	110 mm	660055	18,91	40	0,458

VERIFICACIÓN Y RACORES INCLUIDOS

Revisión A



**MOD. SJSDC R100 DN15/20 A/F-A/C**

**CONTADOR 8 RODILLOS ESFERA SECA CON EMISOR DE IMPULSOS**

**HOMOLOGADO**



MODELO	30°C / 90°C	DIÁMETRO	LONGITUD	REF.	EUROS	UD. EMBALAJE	PESO UNID.
SJ-SDC-PLUS	A/F	1/2" 13mm	115 mm	NW621107	36,72	20	0,480
SJ-SDC-PLUS	A/F	1/2" 15mm	115 mm	NW621103	35,30	20	0,450
SJ-SDC-PLUS	A/C	1/2" 15mm	115 mm	NW621104	38,96	20	0,450
SJ-SDC-PLUS	A/F	3/4" 20mm	130 mm	NW621105	46,02	20	0,510
SJ-SDC-PLUS	A/C	3/4" 20mm	130 mm	NW621106	47,82	20	0,510

VALOR DE IMPULSOS 1P-1-1P-10

VERIFICACIÓN Y RACORES INCLUIDOS

**MOD. SJSDC PLUS R160 DN 15 A/F**

**CONTADOR 8 RODILLOS ESFERA SECA CON EMISOR DE IMPULSOS**

**HOMOLOGADO**



MODELO	30°C	DIÁMETRO	LONGITUD	REF.	EUROS	UD. EMBALAJE	PESO UNID.
SJ-SDC PLUS	A/F	1/2" 13mm	115 mm	NW641104	37,03	20	0,480
SJ-SDC PLUS	A/F	1/2" 15mm	115 mm	NW641103	35,62	20	0,460
SJ-SDC PLUS	A/F	3/4" 20mm	130 mm	NW641105	46,44	20	0,530

VALOR DE IMPULSOS 1P-1-1P-10

VERIFICACIÓN Y RACORES INCLUIDOS

Revisión A

**CONJUNTOS MONTADOS PARA LECTURA DE AGUA CALIENTE SANITARIA**



<b>CONJUNTO CON VÁLVULAS ESFERA 1/2" – H RACOR 3/4" Y CONTADOR A/C DN 15</b>			
REF.	EUROS	UNID. DE EMBALAJE	PESO UNID.
990205	46,90	10	1,000
<b>CONJUNTO CON VÁLVULAS ESFERA 3/4" – H RACOR 3/4" Y CONTADOR A/C DN 15</b>			
REF.	EUROS	UNID. DE EMBALAJE	PESO UNID.
990207	60,27	10	1,220
<b>CONJUNTO CON VÁLVULAS ESFERA 3/4" – H RACOR 1" Y CONTADOR A/C DN 20</b>			
REF.	EUROS	UNID. DE EMBALAJE	PESO UNID.
990208	72,21	10	1,470



<b>CONJUNTO CON VÁLVULAS ESFERA 1/2" – H RACOR 3/4" Y CONTADOR IMPULSOS A/C DN 15</b>			
REF.	EUROS	UNID. DE EMBALAJE	PESO UNID.
990209	55,59	10	1,016
<b>CONJUNTO CON VÁLVULAS ESFERA 3/4" – H RACOR 3/4" Y CONTADOR IMPULSOS A/C DN 15</b>			
REF.	EUROS	UNID. DE EMBALAJE	PESO UNID.
990214	69,35	10	1,236
<b>CONJUNTO CON VÁLVULAS ESFERA 3/4" – H RACOR 1" Y CONTADOR IMPULSOS A/C DN 20</b>			
REF.	EUROS	UNID. DE EMBALAJE	PESO UNID.
990217	82,04	10	1,486

**CONJUNTOS MONTADOS CON SOPORTE DE FIJACIÓN PARA LECTURA DE AGUA FRÍA Y CALIENTE SANITARIA**



<b>CONJUNTO CON VÁLVULAS ESFERA 3/4" M – RACOR 3/4" Y CONTADOR A/F Y A/C DN 15</b>			
REF.	EUROS	UNID. DE EMBALAJE	PESO UNID.
990201	143,80	1	2,000
<b>CONJUNTO CON VÁLVULAS ESFERA 3/4" M – RACOR 1" Y CONTADOR A/F Y A/C DN 20</b>			
REF.	EUROS	UNID. DE EMBALAJE	PESO UNID.
990211	160,63	1	2,250

PARA OTRAS COMBINACIONES CONSULTAR MONTAJE ESTANDAR CON CONEXIÓN DE ENTRADA POR LA IZQUIERDA

Revisión A

### CONTADORES CHORRO MÚLTIPLE R80/R100

#### MOD. KVS

#### CONTADOR CHORRO MÚLTIPLE CUADRANTE SECO A/F – R80/R100

HOMOLOGADO



MODELO	A/F 30°C	DIÁMETRO	LONGITUD	REF.	EUROS	UNID. EMBALAJE	PESO UNID.
KVS	3 M3	1/2" 15mm	165 mm	660029	33,74	20	1,900
KVS	5 M3	3/4" 20mm	190 mm	660030	56,01	20	2,500
KVS	7 M3	1" 25mm	260 mm	660031	81,35	10	2,700
KVS	12 M3	1 1/4" 30mm	260 mm	660032	99,59	10	2,800
KVS	20 M3	1 1/2" 40mm	300 mm	660033	164,71	5	5,100
KVS	30 M3	2" 50mm	300 mm	660034	207,94	4	7,400

\*\*\*INCREMENTO PARA R160: 1,80 EUROS\*\*\*

RACORES INCLUIDOS

VERIFICACIÓN NO INCLUIDA

#### MOD. MJ-SDC

#### CONTADOR CHORRO MÚLTIPLE CUADRANTE SECO A/C – R100

HOMOLOGADO



MODELO	A/C 90°C	DIÁMETRO	LONGITUD	REF.	EUROS	UNID. EMBALAJE	PESO UNID.
MJ-SDC	3 M3	1/2" 15mm	165 mm	660398	55,60	20	1,900
MJ-SDC	5 M3	3/4" 20mm	190 mm	660399	63,72	20	2,500
MJ-SDC	7 M3	1" 25mm	260 mm	660400	106,76	10	2,700
MJ-SDC	12 M3	1 1/4" 30mm	260 mm	660401	131,44	10	2,800
MJ-SDC	20 M3	1 1/2" 40mm	300 mm	660402	260,47	5	5,100
MJ-SDC	30 M3	2" 50mm	300 mm	660403	280,65	4	7,400

RACORES INCLUIDOS

#### MOD. KVS

#### CONTADOR CHORRO MÚLTIPLE CON EMISOR DE IMPULSOS A/F - R80/R100

HOMOLOGADO



MODELO	A/F 30°C	DIÁMETRO	LONGITUD	REF.	EUROS	UNID. EMBALAJE	PESO UNID.
KVS	3 M3	1/2" 15mm	165 mm	661129	43,83	20	1,900
KVS	5 M3	3/4" 20mm	190 mm	661130	61,02	20	2,500
KVS	7 M3	1" 25mm	260 mm	661131	91,24	10	2,700
KVS	12 M3	1 1/4" 30mm	260 mm	661132	110,00	10	2,800
KVS	20 M3	1 1/2" 40mm	300 mm	661133	175,47	5	5,100
KVS	30 M3	2" 50mm	300 mm	661134	214,60	4	7,400

RACORES INCLUIDOS

VERIFICACIÓN NO INCLUIDA

#### MOD. MJ-SDC

#### CONTADOR CHORRO MÚLTIPLE CON EMISOR DE IMPULSOS A/C – R100

HOMOLOGADO



MODELO	A/C 90°C	DIÁMETRO	LONGITUD	REF.	EUROS	UNID. EMBALAJE	PESO UNID.
MJ-SDC	3 M3	1/2" 15mm	165 mm	661398	107,65	20	1,900
MJ-SDC	5 M3	3/4" 20mm	190 mm	661399	132,25	20	2,500
MJ-SDC	7 M3	1" 25mm	260 mm	661400	148,10	10	2,700
MJ-SDC	12 M3	1 1/4" 30mm	260 mm	661401	200,64	10	2,800
MJ-SDC	20 M3	1 1/2" 40mm	300 mm	661402	304,43	5	5,100
MJ-SDC	30 M3	2" 50mm	300 mm	661403	345,13	4	7,400

RACORES INCLUIDOS

Revisión A

**MOD. NWM PD-SDC E8 DN15 CONTADOR VOLUMÉTRICO DE PISTÓN ROTATIVO R200  
CUERPO COMPOSITE ESFERA SECA CON PRE-DISPOSICIÓN**
**HOMOLOGADO**

MODELO	A/F 30°C	DIÁMETRO	LONGITUD	REF.	EUROS	UNID. EMBALAJE	PESO UNID.
NWM PD-SDC E8	Q3:2,5 M <sup>3</sup> /h	1/2" 15mm	115 mm	NW710101	36,45	20	0,750
NWM PD-SDC E8(*)	Q3:2,5 M <sup>3</sup> /h	1/2" 15mm	115 mm	NW710107	36,73	20	0,750

(\*) Rosca diferencial 7/8" entrada - 3/4" salida

VERIFICACIÓN DE FÁBRICA Y RACORES INCLUIDOS

**MOD. ASTRAL RTK**
**CONTADOR VOLUMÉTRICO CLASE R160 CON PISTÓN ROTATORIO R160 EN CUALQUIER POSICIÓN HOMOLOGADO**

MODELO	50°C	DIÁMETRO	LONGITUD	REF.	EUROS	UNID. EMBALAJE	PESO UNID.
RTK	A/F	1/2" 15mm	110 mm	660065	57,78	10	0,370
RTK	A/F	3/4" 20mm	190 mm	660066	65,37	10	0,480

\*Hasta fin de existencias

VERIFICACIÓN Y RACORES INCLUIDOS

**MOD. PDLFC DN15-20**
**CONTADOR VOLUMÉTRICO R160/200 CUERPO COMPOSITE Y A.INOX  
CON PRE-DISPOSICIÓN**
**HOMOLOGADO**

MODELO	A/F 30°C	DIÁMETRO	LONGITUD	REF.	EUROS	UD. EMBALAJE	PESO UNID.
PDLFC R160	Q3:2,5 M <sup>3</sup> /h	1/2" 15mm	115 mm	PDLFC1003	31,28	20	0,450
PDLFC R200	Q3:2,5 M <sup>3</sup> /h	1/2" 15mm	115 mm	PDLFC1007	32,84	20	0,450

VERIFICACIÓN Y RACORES INCLUIDOS

**MOD. LXH DN15 CONTADOR VOLUMÉTRICO R160 CUERPO LATÓN  
CON PRE-DISPOSICIÓN**

MODELO	A/F 30°C	DIÁMETRO	LONGITUD	REF.	EUROS	UD. EMBALAJE	PESO UNID.
LXH R160	Q3:2,5 M <sup>3</sup> /h	1/2" 15mm	115 mm	LXH10011	39,09	20	1,100

VERIFICACIÓN Y RACORES INCLUIDOS

Revisión A

**CONTADOR WOLTMAN DE TURBINA R80 AGUA FRÍA 30°  
CON PREEQUIPO PARA EMISOR DE IMPULSOS MOD. WPH K30**

**HOMOLOGADO**



CAUDAL MAX. M <sup>3</sup> -HORA	DIÁMETRO	LONGITUD	REF.	EUROS	UNID. EMBALAJE	PESO UNID.
30 M <sup>3</sup>	2" 50mm	200 mm	660046	308,57	1	12,000
50 M <sup>3</sup>	2 1/2" 65mm	200 mm	660047	344,08	1	13,000
80 M <sup>3</sup>	3" 80mm	225 mm	660048	351,41	1	15,000
120 M <sup>3</sup>	4" 100mm	250 mm	660049	402,21	1	17,000
200 M <sup>3</sup>	5" 125mm	250 mm	660050	482,49	1	19,000
300 M <sup>3</sup>	6" 150mm	300 mm	660051	747,22	1	40,000
500 M <sup>3</sup>	8" 200mm	350 mm	660052	949,06	1	55,000

VERIFICACIÓN NO INCLUIDA

PARA EQUIPAMIENTO CON EMISOR IMPULSOS SUMAR REF. NW1060103 – PAG. 104

**CONTADOR WOLTMAN DE TURBINA R80 AGUA CALIENTE 120°  
CON PREEQUIPO PARA EMISOR DE IMPULSOS MOD. WPH K30**

**NO HOMOLOGADO**



CAUDAL MAX. M <sup>3</sup> -HORA	DIÁMETRO	LONGITUD	REF.	EUROS	UNID. EMBALAJE	PESO UNID.
30 M <sup>3</sup>	2" 50mm	200 mm	660077	382,26	1	9,900
50 M <sup>3</sup>	2 1/2" 65mm	200 mm	660078	385,24	1	10,600
80 M <sup>3</sup>	3" 80mm	225 mm	660079	463,44	1	13,300
120 M <sup>3</sup>	4" 100mm	250 mm	660080	523,74	1	15,600

PARA EQUIPAMIENTO CON EMISOR IMPULSOS SUMAR REF. NW1060103 – PAG. 104

**VERIFICACIÓN PRIMITIVA WOLTMAN**

MODELO	PULGADAS	REF.	PRECIO NETO
WPH K30	2"	1060007	15,03
WPH K30	2 1/2"	1060008	15,03
WPH K30	3"	1060009	15,03
WPH K30	4"	1060010	15,03
WPH K30	5"	1060011	15,03
WPH K30	6"	1060012	15,03
WPH K30	8"	1060013	15,03

**VERIFICACIÓN PRIMITIVA CHORRO MÚLTIPLE**

MODELO	DIAMETRO	REF.	PRECIO NETO
KVS	DN15	1060001	1,50
KVS	DN20	1060002	1,50
KVS	DN25	1060003	2,78
KVS	DN30	1060004	3,76
KVS	DN40	1060005	6,80
KVS	DN50	1060006	6,80

**ACCESORIOS CONTADOR**
**RACOR CONTADOR EN LATÓN**

Ø CONTADOR	REF.	EUROS	UNID. EMBALAJE	PESO UNID.
13mm 7/8" 1/2"	1040002	3,56	25	0,096
15mm 3/4" 1/2"	1040001	3,20	25	0,070
20mm 1" 3/4"	1040003	3,79	20	0,140
25mm 1 1/4" 1"	1040004	7,72	10	0,220
30mm 1 1/2" 1 1/4"	1040005	10,02	10	0,340
40mm 2" 1 1/2"	1040006	16,16	5	0,425
50mm 2 1/2" 2"	1040007	26,86	3	0,850

**RACOR CONTADOR EN NYLON**

Ø CONTADOR	REF.	EUROS	UNID. EMBALAJE	PESO UNID.
15mm 3/4" 1/2"	RNY1001	0,90	100	0,025
15mm 7/8" 1/2"	RNY1002	0,92	100	0,029

**JUNTA RACOR CONTADOR**

Ø RACOR	REF.	EUROS	UNID. DE EMBALAJE	PESO UNID.
7/8" 1/2"	1045001	0,18	25	0,006
3/4" 1/2"	1045002	0,13	25	0,005
1" 3/4"	1045003	0,17	25	0,010
1 1/4" 1"	1045004	0,25	25	0,020
1 1/2" 1 1/4"	1045005	0,33	25	0,030
2" 1 1/2"	1045006	0,34	25	0,030
2 1/2" 2"	1045007	0,59	25	0,070

**ALARGADERA LATÓN M-H 3/4"**

LONGITUD	REF.	EUROS	UNID. EMBALAJE	PESO UNID.
63 mm	99000094	5,66	10	0,108
83 mm	99000118	12,68	10	0,167

VENTA BAJO PEDIDO MÍNIMO DE 500 UNIDADES

Revisión A

### ACCESORIOS CONTADOR

#### CAJA ANTIFRAUDE ESTANDAR MULTIDIÁMETRO



Ø CONTADOR	REF.	EUROS	UNID. EMBALAJE	PESO UNID.
13-15mm	1040704	1,09	25	0,002
20mm	1040705	1,04	25	0,002

#### PRECINTO MANUAL

#### NO PRECISA HERRAMIENTAS



REF.	EUROS	UNID. EMBALAJE	PESO UNID.
1040709	0,57	50	0,002

#### TENAZA PARA PRECINTO DE PLOMO



Ø	REF.	EUROS	UNID. EMBALAJE	PESO UNID.
11 mm	1040502	57,04	1	0,300
13 mm	1040503	64,55	1	0,400

#### PLOMO PARA PRECINTO



Ø PLOMO	REF.	EUROS	UNID. EMBALAJE	PESO UNID.
8 mm	1040701	0,063	410 (1kg. Aprox.)	0,002

#### ROLLO ALAMBRE INOXIDABLE PARA PRECINTO



ROLLO	REF.	EUROS	UNID. EMBALAJE	PESO UNID.
400 mts	1040801	63,90	1	1,22

Revisión A

ACCESORIOS CONTADOR

EMISOR IMPULSOS S20-130 VALOR IMPULSOS 1P-1L-1P-10L ADAPTABLE A LOS MODELOS PFU C, SFU Y SCU DN20

	REF.	EUROS	UNID. EMBALAJE	PESO UNID.
	1060120	16,63	1	0,050

EMISOR IMPULSOS K-10 PARA CONTADOR WOLTMAN Ø50 A 200 VALOR IMPULSOS 1P-100

	REF.	EUROS	UNID. EMBALAJE	PESO UNID.
	NW1060103	20,13	1	0,053

EMISOR IMPULSOS KVS Y MJ-SDC VALOR IMPULSOS 1P-10L-1P-100L

	REF.	EUROS	UNID. EMBALAJE	PESO UNID.
	NW1060101	18,00	1	0,050

EMISOR IMPULSOS SJ-SDC VALOR IMPULSOS 1P-1L-1P-10L

	REF.	EUROS	UNID. EMBALAJE	PESO UNID.
	NW1060100	15,66	1	0,050

Revisión A



ACCESORIOS CONTADOR

CONTADOR PROGRAMABLE CDI-10 220V SALIDA 24V-AC

	REF.	EUROS	UNID. EMBALAJE	PESO UNID.
	1060102	507,43	1	1,300

CONTADOR DE IMPULSOS H7 E C-N 24V-CA MOD. BLM CON SISTEMA PUESTA A CERO

	REF.	EUROS	UNID. EMBALAJE	PESO UNID.
	1060101	204,34	1	0,130

KIT CONTADOR S-110 DN15 DN20 + ELECTROVÁLVULA + CAJA ESTANCA PARA INSTALAR CON CONTADOR PROGRAMABLE CDI-10

	DN	REF.	EUROS	UNID. EMBALAJE	PESO UNID.
	15	1060115	267,22	1	1,100
	20	1060116	320,80	1	1,300

Revisión A

### ACCESORIOS CONTADOR

#### ELECTROVÁLVULA AGUA N.C. 230V AC 50 HC – 24V 50-60 HC



DN	REF.	EUROS	UNID. EMBALAJE	PESO UNID.
15-1/2"	990172	87,11	1	0,450
20-3/4"	990173	113,66	1	0,622
25-1"	990174	135,44	1	1,200
32-1 1/2"	990175	282,69	1	2,900
40-1 1/2"	990176	299,97	1	3,300
50-2"	990177	351,53	1	3,900

#### ELECTROVÁLVULA AGUA N.A. 230V AC 50 HC – 24V 50-60 HC



DN	REF.	EUROS	UNID. EMBALAJE	PESO UNID.
15-1/2"	990181	106,36	1	0,450
20-3/4"	990182	123,22	1	0,622
25-1"	990183	147,53	1	1,200
32-1 1/2"	990184	259,42	1	2,900
40-1 1/2"	990185	323,43	1	3,300
50-2"	990186	407,73	1	3,900

Revisión A

# CALEFACCIÓN

Revisión A

**23/01**



Revisión A

**ÍNDICE**

**PAG. 109..... CONTADORES DE ENERGIA PARA USO DOMÉSTICO**

**PAG. 110-111..... MÓDULOS PARA CONTABILIZACIÓN**

**PAG. 112-114..... ACCESORIOS PARA CALEFACCIÓN**

**PAG. 115..... CONVERTIDORES DE SEÑAL**

**PAG. 116..... CENTRALITAS M-BUS Y MÓDEM**



Revisión A

### CONTADOR DE ENERGÍA TÉRMICA SENSOSTAR 2 ESH

#### CONTADOR DE ENERGÍA MODELO ESH



MODELO	DN mm	LONGITUD mm	CAUDAL MÁX. m <sup>3</sup> /h	CAUDAL NOM. m <sup>3</sup> /h	CAUDAL MÍN. l/h	TEMP. MÁX. °C	REF.	EUROS	UNID. EMBALAJE	PESO UNID.
ESH	15	110	3	1,5	30	90	660056	214,38	20	0,800
ESH	20	130	5	2,5	50	90	660057	226,44	20	0,950

RACORES INCLUIDOS

#### CONTADOR DE ENERGÍA MODELO ESH EQUIPADO CON M-BUS



MODELO	DN mm	LONGITUD mm	CAUDAL MÁX. m <sup>3</sup> /h	CAUDAL NOM. m <sup>3</sup> /h	CAUDAL MÍN. l/h	TEMP. MÁX. °C	REF.	EUROS	UNID. EMBALAJE	PESO UNID.
ESH	15	110	3	1,5	30	90	660058	246,29	20	0,800
ESH	20	130	5	2,5	50	90	660059	256,95	20	0,950

RACORES INCLUIDOS

#### CONTADOR DE ENERGÍA MODELO ESH EQUIPADO CON M-BUS Y ENTRADA DE IMPULSOS



MODELO	DN mm	LONGITUD mm	CAUDAL MÁX. m <sup>3</sup> /h	CAUDAL NOM. m <sup>3</sup> /h	CAUDAL MÍN. l/h	TEMP. MÁX. °C	REF.	EUROS	UNID. EMBALAJE	PESO UNID.
ESH	15	110	3	1,5	30	90	660053	268,12	20	0,800
ESH	20	130	5	2,5	50	90	660054	280,17	20	0,950

RACORES INCLUIDOS

#### SENSOSTAR 2C BÁSICO CON SONDAS DE TEMPERATURA



VALOR IMPULSOS	TEMP. MÁX. °C	REF.	EUROS	UNID. EMBALAJE	PESO UNID.
VARIABLE	150	660060	331,01	1	0,310

#### SENSOSTAR 2C CON M-BUS Y SONDAS DE TEMPERATURA



VALOR IMPULSOS	TEMP. MÁX. °C	REF.	EUROS	UNID. EMBALAJE	PESO UNID.
VARIABLE	150	660095	363,61	1	0,310

Revisión A

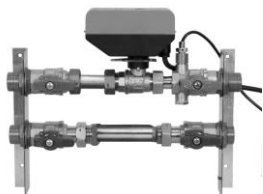
**MÓDULOS COMPACTOS PARA LA CONTABILIZACIÓN DE LOS CONSUMOS TERMOSANITARIOS EQUIPADOS CON M-BUS Y ENTRADA DE IMPULSOS**

**KIT CALEFACCIÓN SERIE BS-K80 CON ANCLAJES DE SUJECCIÓN  
DN15 2 VÍAS CONEXIÓN 3/4" R/M**

REF.	EUROS	UNID. DE EMBALAJE	PESO UNID.
560080	337,57	1	2,900

**KIT CALEFACCIÓN SERIE BS-K80 CON ANCLAJES DE SUJECCIÓN  
DN20 2 VÍAS CONEXIÓN 3/4" R/M**

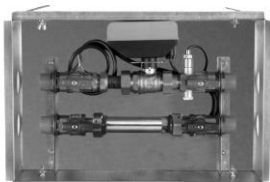
REF.	EUROS	UNID. DE EMBALAJE	PESO UNID.
560081	356,14	1	3,000

**KIT CALEFACCIÓN SERIE BS-K80 CON ARMARIO METÁLICO  
DN 15 2 VÍAS CONEXIÓN 3/4" R/M**

REF.	EUROS	UNID. DE EMBALAJE	PESO UNID.
540080	448,98	1	5,000

**KIT CALEFACCIÓN SERIE BS-K80 CON ARMARIO METÁLICO  
DN 20 2 VÍAS CONEXIÓN 3/4" R/M**

REF.	EUROS	UNID. DE EMBALAJE	PESO UNID.
540081	442,90	1	5,300

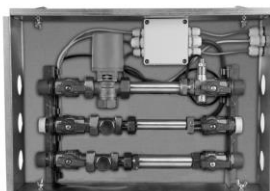
**MÓDULO DE USUARIO SERIE BS-K100VZ - 2 VIAS DN 15  
CONEXIÓN 3/4" R/M**

REF.	EUROS	UNID. DE EMBALAJE	PESO UNID.
540100	518,16	1	17,500

**MÓDULO DE USUARIO SERIE BS-K100VZ - 2 VIAS DN 20  
CONEXIÓN 3/4" R/M**

REF.	EUROS	UNID. DE EMBALAJE	PESO UNID.
540101	518,29	1	17,500

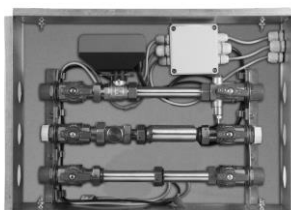
**MÓDULO DE USUARIO SERIE BS-K120SV - 2 VIAS DN 15  
CONEXIÓN 3/4" R/M**

REF.	EUROS	UNID. DE EMBALAJE	PESO UNID.
540120	627,54	1	17,500

**MÓDULO DE USUARIO SERIE BS-K120SV - 2 VIAS DN 20  
CONEXIÓN 3/4" R/M**

REF.	EUROS	UNID. DE EMBALAJE	PESO UNID.
540121	636,91	1	18,000

PARA INFORMACIÓN MÁS DETALLADA CONSULTAR EL CATALOGO TÉCNICO  
MONTAJE ESTANDAR CON CONEXIÓN DE ENTRADA POR LA IZQUIERDA

Revisión A

**MÓDULOS COMPACTOS PARA LA CONTABILIZACIÓN DE LOS CONSUMOS TERMOSANITARIOS EQUIPADOS CON M-BUS Y ENTRADA DE IMPULSOS**

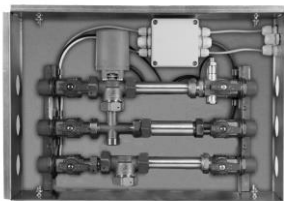

**MÓDULO DE USUARIO SERIE BS-K220VZ – 3 VIAS SIN REGULACIÓN**

**DN15 CONEXIÓN 3/4" R/M**

REF.	EUROS	UNID. DE EMBALAJE	PESO UNID.
540220	515,72	1	18,000

**MÓDULO DE USUARIO SERIE BS-K220VZ – 3 VIAS SIN REGULACIÓN**

**DN20 CONEXIÓN 3/4" R/M**

REF.	EUROS	UNID. DE EMBALAJE	PESO UNID.
540221	519,77	1	18,100

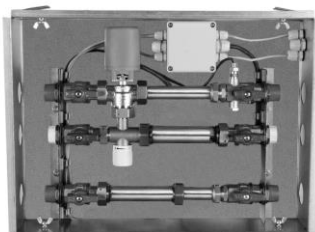

**MÓDULO DE USUARIO SERIE BS-K240VZ – 3 VIAS CON REGULACIÓN**

**DN15 CONEXIÓN 3/4" R/M**

REF.	EUROS	UNID. DE EMBALAJE	PESO UNID.
540240	529,37	1	18,700

**MÓDULO DE USUARIO SERIE BS-K240VZ – 3 VIAS CON REGULACIÓN**

**DN20 CONEXIÓN 3/4" R/M**

REF.	EUROS	UNID. DE EMBALAJE	PESO UNID.
540241	522,50	1	19,000

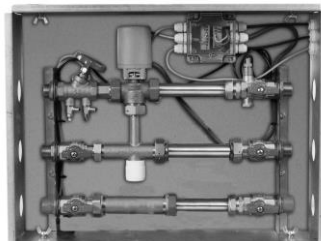

**MÓDULO DE USUARIO SERIE BS-K260VZ – 3 VIAS CON VÁLVULA DE EQUILIBRADO Y BY-PASS REGULABLE DN15 CONEXIÓN 3/4" R/M**

REF.	EUROS	UNID. DE EMBALAJE	PESO UNID.
540260	560,56	1	18,700

**MÓDULO DE USUARIO SERIE BS-K260VZ – 3 VIAS CON VÁLVULA DE EQUILIBRADO Y BY-PASS REGULABLE DN20 CONEXIÓN 3/4" R/M**

REF.	EUROS	UNID. DE EMBALAJE	PESO UNID.
540261	541,72	1	19,100

PARA INFORMACIÓN MÁS DETALLADA CONSULTAR EL CATALOGO TÉCNICO MONTAJE ESTANDAR CON CONEXIÓN DE ENTRADA POR LA IZQUIERDA

Revisión A

**VÁLVULA TERMOSTÁTICA CAMPO DE REGULACIÓN: 30°-55°C PRECISIÓN ±2°  
PRESIÓN DE EJERCICIO 10 BAR. MÁX. ESTÁTICA 5 BAR. DINÁMICA TEMPERATURA MÁX. DE ENTRADA  
85° CAUDAL CON 3 BAR. 3000 L/H A 40°**



ROSCA GAS	REF.	EUROS	UNID. EMBALAJE	PESO UNID.
3/4" MACHO	990187	90,66	1	0,343
1" MACHO	990188	174,67	1	0,432

\*Hasta fin de existencias

**VÁLVULA DE ZONA 2 VIAS CONEXIÓN H-H 220 VS/24VS C.A.**



ROSCA GAS	REF.	EUROS	UNID. EMBALAJE	PESO UNID.
1/2"	SF15-2BS	126,06	1	0,810
3/4"	SF20-2BS	127,50	1	0,980
1"	SF25-2BS	132,85	1	1,282

\*Hasta fin de existencias

**VÁLVULA DE ZONA 3 VIAS CONEXIÓN MACHO 220 VS**



ROSCA GAS	REF.	EUROS	UNID. EMBALAJE	PESO UNID.
3/4"	SF20E2BS	129,06	1	1,100
1"	SF25E2BS	134,42	1	1,310

\*Hasta fin de existencias

**COLECTOR ABIERTO COMPONIBLE M-H CONEXIONES 1/2" M-Ø 12-14-15 y 16**



COLECTOR/N° SALIDAS	REF.	EUROS	UNID. EMBALAJE	PESO UNID.
3/4" - 2	170025	6,19	10	0,150
3/4" - 3	170026	11,79	10	0,226
1" - 2	170028	9,67	10	0,235
1" - 3	170029	13,24	10	0,353
1" - 4	170030	16,11	10	0,416
1" - 5	170031	17,84	10	0,519

\*Hasta fin de existencias

**COLECTOR COMPONIBLE PARA A.C.S. CON VÁLVULAS 3/4" M-H CONEXIONES 1/2" M-Ø 12-14-15 y 16**



N° SALIDAS	COLOR VOLANTE	REF.	EUROS	UNID. EMBALAJE	PESO UNID.
2	AZUL	170032	30,82	5	0,311
2	ROJO	170033	25,60	5	0,311
3	AZUL	170034	30,86	5	0,446
3	ROJO	170035	30,86	5	0,446
4	AZUL	170036	46,05	5	0,620
4	ROJO	170037	46,05	5	0,620

\*Hasta fin de existencias

Revisión A



**CONJUNTO RACOR Y BICONO**

MEDIDA	REF.	EUROS	UNID. EMBALAJE	PESO UNID.
1/2" x 10	1040012	1,21	50	0,038
1/2" x 12	1040013	1,15	50	0,042
1/2" x 14	1040014	1,15	50	0,046
1/2" x 15	1040015	0,95	50	0,051
1/2" x 16	1040016	0,89	50	0,056

\*Hasta fin de existencias

**RACOR PARA TUBO MULTICAPA Y PLÁSTICO**

MEDIDA	REF.	EUROS	UNID. EMBALAJE	PESO UNID.
1/2" x 14 x 10	1040017	1,79	50	0,039
1/2" x 16 x 12	1040018	1,71	50	0,045

\*Hasta fin de existencias

**CAJA DE PLÁSTICO PARA COLECTOR**

MEDIDA	REF.	EUROS	UNID. EMBALAJE	PESO UNID.
32 x 26 x 9,5	530121	30,41	1	1,320
40 x 26 x 9,5	530122	33,78	1	1,410
50 x 26 x 9,5	530123	36,72	1	1,630

\*Hasta fin de existencias

**CAJA METÁLICA PARA EMPOTRAR**

MEDIDA	REF.	EUROS	UNID. EMBALAJE	PESO UNID.
450 x 400	530124	111,04	1	3,500
450 x 600	530125	132,08	1	4,700
450 x 800	530126	158,65	1	6,500
450 x 1000	530127	253,97	1	8,400

\*Hasta fin de existencias

**SOPORTE METÁLICO MULTIDIÁMETRO PARA COLECTORES**



MEDIDA	REF.	EUROS	UNID. EMBALAJE	PESO UNID.
3/4"-1"-1 1/4"	539904	7,84	2	0,310

\*Hasta fin de existencias

Revisión A

## ACCESORIOS

### CONJUNTO SENSOR DE TEMPERATURA

	Ø SENSOR	LONG. SENSOR	REF.	EUROS	UNID. EMBALAJE	PESO UNID.
	5,0 mm	45 mm	SS3-106	68,54	2	0,064
	5,2 mm	105 mm	SM3-107	75,16	2	0,088
HASTA FIN DE EXISTENCIAS	6,0 mm	140 mm	SL3-108	114,89	2	0,104

### PORTASONDAS PARA CONTADOR DN15 Y DN20

	ROSCA GAS	LONGITUD	REF.	EUROS	UNID. EMBALAJE	PESO UNID.
	G-1/2" x M-10	40 mm	EGM1520	5,92	2	0,070

### PORTASONDAS PARA SENSOR DE TEMPERATURA

	ROSCA GAS	LONGITUD	REF.	EUROS	UNID. EMBALAJE	PESO UNID.
	G-1/2"	85 mm	PM-110	67,93	2	0,113
	G-1/4"	35 mm	PS-109	20,32	2	0,117

### VÁLVULA PORTASONDAS

	ROSCA GAS	REF.	EUROS	UNID. EMBALAJE	PESO UNID.
	3/4" x M10	99000037	12,48	50	0,270

### VÁLVULA DE EQUILIBRADO REGULACIÓN MICROMÉTRICA

	ROSCA GAS	REF.	EUROS	UNID. EMBALAJE	PESO UNID.
	3/4" H-H	990189	13,98	5	0,316
	1" H-H	990190	20,40	5	0,457

\*Hasta fin de existencias

### LLAVE DE TARADO REGULACIÓN MICROMÉTRICA

	REF.	EUROS	UNID. EMBALAJE	PESO UNID.
	990191	40,27	1	0,130

\*Hasta fin de existencias

Revisión A

**CONVERTIDORES DE SEÑAL  
ENTRADA IMPULSOS SALIDA M-BUS**

**PAD PULS M 1 (PARA 1 CONTADOR)**

	REF.	EUROS	UNID. EMBALAJE	PESO UNID.
	IM001G	129,90	1	0,050

**PAD PULS M 2 (PARA 2 CONTADORES)**

	REF.	EUROS	UNID. EMBALAJE	PESO UNID.
	IM003G	135,32	1	0,065

**PAD PULS M 4 (PARA 4 CONTADORES)**

	REF.	EUROS	UNID. EMBALAJE	PESO UNID.
	IM002GC	257,10	1	0,150

**M-BUS MICRO-MASTER MÓDULO DE CONFIGURACIÓN (PARA MÁXIMO 10 CONTADORES)**

	REF.	EUROS	UNID. EMBALAJE	PESO UNID.
	MR003USB	430,30	1	0,098

Revisión A

### CENTRALITAS

#### M-BUS MASTER FAMILY C20



REF.	EUROS	UNID. EMBALAJE	PESO UNID.
20MR006DL	1.181,39	1	0,220

#### M-BUS MASTER FAMILY W60



REF.	EUROS	UNID. EMBALAJE	PESO UNID.
60MR004DL	1.516,40	1	0,310

#### M-BUS CENTRAL UNIT 120/250



REF.	EUROS	UNID. EMBALAJE	PESO UNID.
250DR001	3.401,51	1	1,200
120DR002	3.112,01	1	1,380

#### MODEM TERMINAL GSM SINTEON MC52IT+ANTENA



REF.	EUROS	UNID. EMBALAJE	PESO UNID.
MOD00005	671,14	1	0,294

Revisión A

# ACCESORIOS PARA OBRA CIVIL Y RIEGO

Revisión A

**23/01**



Revisión A

**ÍNDICE**

PAG. 119-120.....	VÁLVULAS COMPUERTA Y FILTROS
PAG. 121.....	VÁLVULAS RETENCIÓN PORTABRIDAS PVC Y BRIDAS PARA PORTABRIDAS
PAG. 122.....	BRIDAS PLANAS SOLDAR Y ROSCADAS
PAG. 123.....	BRIDAS DOBLE CÁMARA Y UNIÓN UNIVERSAL CON BRIDA
PAG. 124.....	BRIDAS REDUCTORAS
PAG. 125-126.....	UNIÓNES GIBAULT – MULTIMEDIDA
PAG. 127.....	BRIDAS MULTIMEDIDA - ANTITRACCIÓN
PAG. 128-129.....	COLLARINES
PAG. 130.....	CABEZAL ROSCADO Y BANDA DE ACERO INOXIDABLE
PAG. 131-135.....	CABEZAL BRIDA Y UNIÓN ARPOL EN ACERO INOXIDABLE
PAG. 136-137.....	ABRAZADERAS DE REPARACIÓN
PAG. 138.....	VENTOSAS

Revisión A

### ACCESORIOS PARA OBRA CIVIL Y RIEGO

#### VÁLVULA DE COMPUERTA DE CIERRE ELÁSTICO TIPO BRIDA (GGG-50)



DN	REF.	EUROS	UNID. EMBALAJE	PESO UNID.
50	200401	102,34	1	10,000
60	200402	120,40	1	13,000
80	200403	147,49	1	21,000
100	200404	183,61	1	23,000
125	200405	258,86	1	31,000
150	200406	307,02	1	42,000
200	200407	481,60	1	67,000

LAS VÁLVULAS DE COMPUERTA SE SIRVEN CON VOLANTE. PARA VÁLVULAS CON CUADRADILLO ESPECIFICAR EN PEDIDO

#### VÁLVULA COMPUERTA CIERRE ELÁSTICO CONEXIÓN PARA PVC CON VOLANTE (GGG-40)



DN	REF.	EUROS	UNID. EMBALAJE	PESO UNID.
50	200201	146,29	1	9,500
65	200202	190,98	1	12,000
80	200203	232,97	1	15,000
100	200204	306,12	1	19,000
125	200205	468,66	1	25,000
150	200206	490,33	1	34,000
200	200207	736,85	1	55,000
250	200208	1.221,76	1	86,000
300	200209	2.255,24	1	120,000

LAS VÁLVULAS DE COMPUERTA SE SIRVEN CON VOLANTE. PARA VÁLVULAS CON CUADRADILLO ESPECIFICAR EN PEDIDO

#### VÁLVULA DE REGISTRO ROSCA HEMBRA (GGG-40)



DN	REF.	EUROS	UNID. EMBALAJE	PESO UNID.
20	200561	107,01	1	3,000
25	200562	109,71	1	3,000
32	200563	124,61	1	4,000
40	200564	154,41	1	5,000
50	200565	190,98	1	6,000

Revisión A

ACCESORIOS PARA OBRA CIVIL Y RIEGO

VÁLVULA DE MARIPOSA EN ACERO INOXIDABLE TIPO WAFER



DN	REF.	EUROS	UNID. EMBALAJE	PESO UNID.
50	200361	54,33	1	4,000
65	200362	62,40	1	5,000
80	200363	69,47	1	6,000
100	200364	99,78	1	7,300
125	200365	144,60	1	11,000
150	200366	189,30	1	12,000
200	200367	302,23	1	13,000
250	200368	456,83	1	34,000
300	200369	706,66	1	46,000

VÁLVULA DE MARIPOSA TIPO WAFER



DN	REF.	EUROS	UNID. EMBALAJE	PESO UNID.
50 - 2"	200461	47,77	1	4,000
65 - 2 1/2"	200462	55,96	1	5,000
80 - 3"	200463	60,62	1	6,000
100 - 4"	200464	82,93	1	7,300
125 - 5"	200465	112,78	1	11,000
150 - 6"	200466	142,73	1	12,000
200 - 8"	200467	196,22	1	13,000

FILTRO DE FUNDICIÓN CON BRIDAS (GGG-40)



DN	REF.	EUROS	UNID. EMBALAJE	PESO UNID.
50	220104	77,90	1	8,500
65	220105	101,14	1	12,000
80	220106	131,09	1	15,000
100	220107	155,14	1	22,000
125	220108	250,64	1	34,000
150	220109	348,53	1	45,000
200	220110	554,44	1	75,000

Revisión A



ACCESORIOS PARA OBRA CIVIL Y RIEGO

VÁLVULA RETENCIÓN DOBLE CLAPETA



DN	REF.	EUROS	UNID. EMBALAJE	PESO UNID.
50	210401	48,16	1	1,600
65	210402	65,02	1	2,200
80	210403	79,92	1	3,500
100	210404	91,05	1	4,700
125	210405	134,10	1	6,500
150	210406	173,53	1	8,000
200	210407	294,68	1	14,000

MANGUITO PORTABRIDAS PVC



DN	REF.	EUROS	UNID. EMBALAJE	PESO UNID.
50	2000001	0,99	1	0,140
63	2000002	2,83	1	0,165
75	2000003	3,88	1	0,205
90	2000004	4,98	1	0,298
110	2000005	9,09	1	0,387
125	2000006	12,13	1	0,416
140	2000007	15,14	1	0,596
160	2000008	20,33	1	0,832
200	2000009	36,10	1	1,310
250	2000010	52,99	1	1,600

Revisión A

BRIDA PLANA PORTABRIDAS PN10-16



DN	REF.	EUROS	UNID. EMBALAJE	PESO UNID.
63	2100001	13,48	1	2,000
75	2100002	14,55	1	2,000
90	2100003	14,36	1	2,270
110	2100004	16,04	1	2,410
125	2100005	21,52	1	2,970
160	2100007	24,98	1	3,580
200	2100008	38,05	1	5,430

### BRIDAS PN10/16

#### BRIDA PLANA PARA SOLDAR PN-10/16 – DIN-2576



DN	PN	PULGADAS	REF.	EUROS	UNID. EMBALAJE	PESO UNID.
32	10	1 1/4"	1010701	12,17	1	1,870
40	10	1 1/2"	1010702	13,64	1	2,200
50	10	2"	1010703	15,15	1	2,820
65	10	2 1/2"	1010704	17,54	1	3,450
80	10	3"	1010705	19,98	1	4,210
100	16	4"	1010706	27,28	1	4,650
125	16	5"	1010707	28,56	1	5,970
150	16	6"	1010708	39,98	1	6,980

#### BRIDA PLANA ROSCADA PN-10/16 – DIN-2576 ZINCADA



DN	PN	PULGADAS	REF.	EUROS	UNID. EMBALAJE	PESO UNID.
32	10	1 1/4"	1010801	11,94	1	1,870
40	10	1 1/2"	1010802	13,56	1	2,200
50	10	2"	1010803	13,35	1	2,820
65	10	2 1/2"	1010804	15,97	1	3,450
80	10	3"	1010805	20,16	1	4,210
100	16	4"	1010806	35,31	1	4,650

### BRIDAS PN6

#### BRIDA PLANA PARA PORTABRIDAS PN-6 – DIN-2573 ZINCADA



DN	PN	PULGADAS	REF.	EUROS	UNID. EMBALAJE	PESO UNID.
50	6	2"	10040815	9,23	1	1,221
65	6	2 1/2"	10040813	11,16	1	1,477
80	6	3"	10040814	18,26	1	2,534

CONSULTAR DISPONIBILIDAD

#### BRIDA PLANA ROSCADA PN-6 – DIN-2573 ZINCADA



DN	PN	PULGADAS	REF.	EUROS	UNID. EMBALAJE	PESO UNID.
50	6	2"	10031113	12,28	1	1,509
65	6	2 1/2"	10031114	15,60	1	1,965
80	6	3"	10031115	23,02	1	3,047

CONSULTAR DISPONIBILIDAD

Revisión A

**ACCESORIOS PARA OBRA CIVIL Y RIEGO**
**BRIDA DOBLE CÁMARA P-E CON CIERRE DE METAL**

TUBO Ø	BRIDA DN	REF.	EUROS	UNID. EMBALAJE	PESO UNID.
63	50 - 2"	1011101	44,70	1	2,800
75	65 - 2 1/2"	1011102	48,76	1	2,950
90	80 - 3"	1011103	56,89	1	3,600
110	100 - 4"	1011104	70,43	1	4,300
125	125 - 5"	1011105	88,04	1	5,500
160	150 - 6"	1011107	128,68	1	7,300
200	200 - 8"	1011109	243,81	1	12,000

**BRIDA DOBLE CÁMARA PVC**

TUBO Ø	BRIDA DN	REF.	EUROS	UNID. EMBALAJE	PESO UNID.
63	65 - 2 1/2"	1011001	28,44	1	2,800
75	65 - 2 1/2"	1011002	32,51	1	2,950
90	80 - 3"	1011003	36,57	1	3,600
110	100 - 4"	1011004	43,34	1	4,300
125	125 - 5"	1011005	58,70	1	5,500
140	125 - 5"	1011006	66,37	1	5,500
160	150 - 6"	1011007	82,62	1	7,300
200	200 - 8"	1011009	140,87	1	12,000

**UNIÓN UNIVERSAL CON BRIDA**

TUBO Ø	MÍN.	MÁX.	REF.	EUROS	UNID. EMBALAJE	PESO UNID.
65	72	85	290101	65,02	1	4,500
80	88	103	290102	75,85	1	4,900
100	108	128	290103	83,98	1	5,500
125	132	154	290104	116,49	1	7,800
150	159	182	290105	128,68	1	8,300
200	218	238	290107	161,19	1	11,300

Revisión A

ACCESORIOS PARA OBRA CIVIL Y RIEGO

BRIDA REDUCTORA



DN	REF.	EUROS	UNID. EMBALAJE	PESO UNID.
080-050	1010901	52,34	1	3,790
080-060	1010902	53,57	1	3,500
100-050	1010903	58,41	1	4,330
100-060	1010904	60,56	1	4,000
100-080	1010905	79,42	1	4,500
125-060	1010907	65,07	1	5,460
125-080	1010908	79,23	1	5,700
125-100	1010909	78,25	1	5,800
150-060	1010911	74,97	1	6,570
150-080	1010912	90,93	1	6,500
150-100	1010913	91,78	1	6,500
200-100	1010916	119,69	1	9,600
200-150	1010918	118,77	1	9,650
250-100	1010921	214,76	1	12,600
250-150	1010923	187,39	1	12,900
250-200	1010924	207,96	1	13,100

Revisión A

### ACCESORIOS PARA OBRA CIVIL Y RIEGO

#### UNIÓN GIBALT PARA PVC CON TORNILLO ACERO ZINCADO



DN	LONGITUD	REF.	EUROS	UNID. EMBALAJE	PESO UNID.
63	105	340001	16,13	1	1,250
75	104	340002	18,87	1	2,000
90	116	340003	22,64	1	2,900
110	109	340004	31,54	1	4,000
125	114	340005	36,33	1	4,800
140	135	340006	45,48	1	5,000
160	156	340007	55,20	1	6,000
180	158	340008	69,20	1	8,000
200	158	340009	95,75	1	10,000

#### UNIÓN MULTIMEDIDA PN16 CON TOLERANCIA



DN	TOLERANCIA Mín. – Máx.	REF.	EUROS	UNID. EMBALAJE	PESO UNID.
65	68-85	360001	69,08	1	4,500
80	84-106	360002	88,04	1	5,000
100	109-133	360003	107,01	1	5,700
125	132-157	360004	146,29	1	7,500
150	157-183	360005	149,00	1	8,900
175	193-215	360006	182,86	1	9,700
200	218-242	360007	211,30	1	10,000

#### UNIÓN DE TRANSICIÓN AUTOBLOCANTE UNIVERSAL



TOLERANCIA	REF.	EUROS	UNID. EMBALAJE	PESO UNID.
57-74/63	310001	224,85	1	4,980
68-85/75	310002	235,68	1	5,730
84-106/90	310003	272,25	1	7,380
99-119/90	310004	323,73	1	8,050
99-119/110	310005	342,69	1	8,620
109-133/110	310006	357,59	1	9,690
109-133/125	310007	391,45	1	9,750
132-157/125	310008	423,96	1	11,490
132-157/140	310009	441,57	1	11,560
157-183/160	310010	491,68	1	13,690
193-215/200	310011	639,32	1	17,890
218-242/200	310012	679,96	1	20,250

Revisión A

**ACCESORIOS PARA OBRA CIVIL Y RIEGO**
**UNIÓN MULTIMEDIDA PN16**

Ø	REF.	EUROS	UNID. EMBALAJE	PESO UNID.
61-94	370001	216,72	1	11,000
81-114	370002	268,19	1	14,300
106-164	370003	292,57	1	15,590
131-164	370004	371,13	1	20,000
156-194	370005	419,90	1	23,480
191-229	370006	472,72	1	27,420
216-257	370007	558,05	1	31,560
241-279	370008	651,51	1	35,090
236-274	370009	632,55	1	35,500
271-309	370010	656,93	1	38,960
311-351	370011	755,81	1	42,340
349-389	370012	781,55	1	44,630
396-434	370013	1.078,18	1	48,440
436-469	370014	1.216,34	1	53,600
471-504	370015	1.339,60	1	59,080
506-539	370016	1.740,53	1	64,200

Revisión A

**UNIÓN MULTIMEDIDA GRAN TOLERANCIA PN16**

Ø	REF.	EUROS	UNID. EMBALAJE	PESO UNID.
156-194	390001	528,26	1	22,200
191-229	390002	662,35	1	28,800
216-257	390003	734,14	1	32,900
311-349	390004	869,59	1	37,600
351-389	390005	1.217,70	1	42,000
396-434	390006	1.213,63	1	45,300
396-434	390007	1.270,52	1	49,500
396-434	390008	1.502,14	1	56,200
471-504	390009	1.481,82	1	58,000
471-504	390010	1.605,08	1	63,000
506-539	390011	1.745,95	1	65,600
576-609	390012	1.924,74	1	71,000

**ACCESORIOS PARA OBRA CIVIL Y RIEGO**
**BRIDA MULTIMEDIDA**

DN	REF.	EUROS	UNID. EMBALAJE	PESO UNID.
300	350001	931,90	1	36,000
300	350002	1.022,65	1	36,000
350	350003	1.061,93	1	39,000
400	350004	1.309,80	1	54,000
400	350005	1.424,93	1	57,000
500	350006	1.744,60	1	75,000
500	350007	1.859,73	1	73,000
500	350008	2.173,97	1	83,500

**UNIÓN ANTITRACCIÓN PARA PVC Y PE**

DN	REF.	EUROS	UNID. EMBALAJE	PESO UNID.
50	330001	97,52	1	2,500
63	330002	101,59	1	2,900
75	330003	108,36	1	3,400
90	330004	123,26	1	4,000
110	330005	153,06	1	5,400
125	330006	209,95	1	6,850
140	330007	228,91	1	8,000
160	330008	251,94	1	8,600
200	330009	348,11	1	12,700
250	330010	707,05	1	24,800
315	330011	995,56	1	32,000
400	330012	1.395,14	1	40,000

Revisión A

**BRIDA ANTITRACCIÓN PARA PVC Y PE**

DN	REF.	EUROS	UNID. EMBALAJE	PESO UNID.
50/63	320001	89,40	1	3,760
65/75	320002	97,52	1	4,120
80/90	320003	107,01	1	4,420
100/110	320004	127,32	1	6,000
125/125	320005	180,15	1	7,200
125/140	320006	182,86	1	7,940
150/160	320007	207,24	1	8,900
200/200 PN10	320008	293,93	1	12,300
200/200 PN16	320009	293,93	1	12,300
250	320010	572,95	1	24,500
315	320011	696,21	1	29,000
400/400	320012	1.002,33	1	45,000

## ACCESORIOS PARA OBRA CIVIL Y RIEGO

## COLLARÍN DE TOMA TIPO ABRAZADERA PARA TUBO P-E Y PVC

Revisión A



DN	ROSCA GAS.	REF.	EUROS	UNID. EMBALAJE	PESO UNID.
50	3/4"	290001-3/4"	21,58	1	1,710
50	1"	290001-1"	21,58	1	1,710
63	3/4"	290002-3/4"	25,43	1	2,300
63	1"	290002-1"	25,43	1	2,300
75	3/4"	290003-3/4"	28,29	1	2,900
75	1"	290003-1"	28,29	1	2,900
75	1 1/4"	290003-1 1/4"	28,96	1	2,900
90	3/4"	290004-3/4"	32,00	1	4,250
90	1"	290004-1"	32,00	1	4,250
90	1 1/4"	290004-1 1/4"	32,51	1	4,250
90	1 1/2"	290004-1 1/2"	32,69	1	4,250
90	2"	290004-2"	35,61	1	4,250
110	3/4"	290005-3/4"	39,13	1	5,100
110	1"	290005-1"	39,13	1	5,100
110	1 1/4"	290005-1 1/4"	39,37	1	5,100
110	1 1/2"	290005-1 1/2"	39,70	1	5,100
110	2"	290005-2"	42,71	1	5,100
125	3/4"	290006-3/4"	45,21	1	6,200
125	1"	290006-1"	45,21	1	6,200
125	1 1/4"	290006-1 1/4"	46,23	1	6,200
125	1 1/2"	290006-1 1/2"	46,41	1	6,200
125	2"	290006-2"	48,37	1	6,200
140	1"	290007-1"	61,22	1	7,050
140	1 1/4"	290007-1 1/4"	63,42	1	7,050
140	1 1/2"	290007-1 1/2"	63,87	1	7,050
140	2"	290007-2"	66,46	1	7,050
160	1"	290008-1"	73,99	1	8,150
160	1 1/4"	290008-1 1/4"	74,92	1	8,150
160	1 1/2"	290008-1 1/2"	75,37	1	8,150
160	2"	290008-2"	76,27	1	8,150



**ACCESORIOS PARA OBRA CIVIL Y RIEGO**
**COLLARÍN FUNDICIÓN SALIDA BRIDA**

MEDIDA	REF.	EUROS	UNID. EMBALAJE	PESO UNID.
110/50-65	270001	109,99	1	3,600
110/80	270002	129,10	1	4,300
125/50-65	270003	140,18	1	4,900
125/80	270004	164,53	1	6,300
140/50-65	270005	159,92	1	6,800
140/80-100	270006	178,16	1	7,600
160/50-65	270007	174,52	1	7,400
160/80-100	270008	186,92	1	8,800
200/50-65	270009	202,42	1	8,800
200/80-100	270010	217,11	1	10,000
200/125-150	270011	291,61	1	13,500
250/50-65	270012	267,47	1	11,500
250/80-100	270013	288,69	1	12,800
250/125-150	270014	370,50	1	17,500
315/50-65	270015	477,72	1	22,500
315/80-100	270016	546,62	1	23,500
315/125-150	270017	652,36	1	31,500
355/80-100	270018	509,53	1	21,000
355/125-150	270019	689,71	1	26,000
355/200 PN16	270020	757,83	1	27,000
400/80-100	270021	593,93	1	26,500
400/125-150	270022	772,82	1	36,200
400/200 PN16	270023	854,33	1	40,000
500/80-100	270024	819,47	1	39,000
500/125-150	270025	966,87	1	40,000
500/200 PN16	270026	1.120,86	1	42,000

Revisión A

**ACCESORIOS PARA OBRA CIVIL Y RIEGO**
**CABEZAL ROSCADO UNIVERSAL**

TUBERÍA	REF.	EUROS	UNID. EMBALAJE	PESO UNID.
3/4"	300001	29,80	1	1,250
1"	300002	29,80	1	1,250
1 1/4"	300003	35,22	1	1,820
1 1/2"	300004	35,22	1	1,810
2"	300005	35,22	1	1,810
2 1/2"	300006	111,07	1	2,000
3"	300007	149,00	1	2,300

**BANDA DE ACERO INOXIDABLE PARA CABEZAL ROSCADO UNIVERSAL**

Ø	REF.	EUROS	UNID. EMBALAJE	PESO UNID.
55-89	300201	40,64	1	0,600
89-119	300202	43,34	1	0,650
106-134	300203	44,70	1	0,680
134-160	300204	46,05	1	0,700
157-187	300205	47,41	1	0,720
187-217	300206	51,47	1	0,750
211-245	300207	52,83	1	0,800
241-271	300208	55,53	1	0,850
266-299	300209	56,89	1	0,900
300-331	300210	59,60	1	0,950
316-346	300211	62,31	1	1,000
326-360	300212	63,66	1	1,000
399-435	300213	102,94	1	1,350
451-485	300214	105,65	1	1,440
499-535	300215	107,01	1	1,550
561-595	300216	108,36	1	1,670
621-655	300217	111,07	1	1,750
676-710	300218	128,68	1	1,860

Revisión A

**ACCESORIOS PARA OBRA CIVIL Y RIEGO**
**CABEZAL BRIDA**

DN	REF.	EUROS	UNID. EMBALAJE	PESO UNID.
50	300101	111,07	1	5,200
60-65	300102	135,45	1	6,500
80	300103	178,79	1	8,500
100	300104	234,33	1	11,300
125	300105	297,99	1	16,300
150	300106	763,94	1	18,400
200 PN10	300107	999,62	1	35,000
200 PN16	300108	999,62	1	35,000

**UNIÓN ARPOL EN ACERO INOXIDABLE PARA CONEXIONES A POLIETILENO**

DN	REF.	EUROS	UNID. EMBALAJE	PESO UNID.
63	290201	258,52	1	0,900
75	290202	290,84	1	1,400
90	290203	313,32	1	1,600
110	290204	342,82	1	1,700
125	290205	393,40	1	2,500
140	290206	463,65	1	2,650
160	290207	497,37	1	2,900
180	290208	883,75	1	7,700
200	290209	955,40	1	8,200
250	290210	1.079,04	1	9,400
315	290211	1.295,41	1	12,500
400	290212	1.680,38	1	18,700

Revisión A

ACCESORIOS PARA OBRA CIVIL Y RIEGO

UNIÓN ARPOL EN ACERO INOXIDABLE  
PARA TUBERÍAS DE VARIOS MATERIALES

ANCHO DE UNIÓN 90 mm



∅	REF.	EUROS	UNID. EMBALAJE	PESO UNID.
74-78	290401	221,99	1	1,590
80-86	290402	226,21	1	1,640
87-93	290403	229,02	1	1,680
98-106	290404	236,04	1	1,810
107-111	290405	237,45	1	1,840
110-116	290406	244,47	1	1,890
118-125	290407	247,28	1	1,970
125-131	290408	247,28	1	1,970
131-136	290409	251,50	1	2,010
137-144	290410	254,31	1	2,050
147-156	290411	261,33	1	2,180
156-162	290412	262,74	1	2,200

Revisión A

ACCESORIOS PARA OBRA CIVIL Y RIEGO

UNIÓN ARPOL EN ACERO INOXIDABLE  
PARA TUBERÍAS DE VARIOS MATERIALES

ANCHO DE UNIÓN 140 mm



Ø	REF.	EUROS	UNID. EMBALAJE	PESO UNID.
166-178	290501	525,47	1	7,660
173-185	290502	525,47	1	7,660
186-198	290503	525,47	1	7,660
194-206	290504	525,47	1	7,660
202-214	290505	564,81	1	8,350
217-229	290506	564,81	1	8,350
231-243	290507	564,81	1	8,350
248-260	290508	564,81	1	8,350
271-283	290509	602,75	1	9,050
279-291	290510	602,75	1	9,050
292-304	290511	602,75	1	9,050
310-322	290512	643,49	1	9,740
320-332	290513	643,49	1	9,740
320-341	290514	643,49	1	9,740
338-350	290515	643,49	1	9,740
349-361	290516	643,49	1	9,740
359-371	290517	681,43	1	10,440
372-384	290518	681,43	1	10,440
379-391	290519	681,43	1	10,440
394-406	290520	681,43	1	10,440
403-415	290521	925,90	1	11,130
410-422	290522	925,90	1	11,130
419-431	290523	925,90	1	11,130
425-437	290524	925,90	1	17,260
433-445	290525	925,90	1	17,260
450-462	290526	973,67	1	18,430
467-479	290527	973,67	1	18,430
477-489	290528	973,67	1	18,430
487-499	290529	973,67	1	18,430
493-505	290530	973,67	1	23,180
504-520	290531	1.142,27	1	23,180
525-541	290532	1.142,27	1	23,180
539-555	290533	1.142,27	1	23,180
557-573	290534	1.197,06	1	23,180
583-599	290535	1.197,06	1	23,180
599-615	290536	1.197,06	1	23,180
614-630	290537	1.240,62	1	22,650
630-646	290538	1.240,62	1	22,650
650-666	290539	939,95	1	22,650
676-692	290540	939,95	1	22,650
706-722	290541	1.357,23	1	22,650
719-735	290542	1.357,23	1	22,650

Revisión A

ACCESORIOS PARA OBRA CIVIL Y RIEGO

UNIÓN ARPOL EN ACERO INOXIDABLE  
PARA TUBERÍAS DE VARIOS MATERIALES

ANCHO DE UNIÓN 200 mm

Revisión A



Ø	REF.	EUROS	UNID. EMBALAJE	PESO UNID.
150-160	290607	525,47	1	7,660
166-178	290608	525,47	1	7,660
173-185	290609	525,47	1	7,660
186-198	290610	525,47	1	7,660
194-206	290611	525,47	1	7,660
202-214	290612	564,81	1	8,350
217-229	290613	564,81	1	8,350
231-243	290614	564,81	1	8,350
242-254	290615	564,81	1	8,350
248-260	290616	564,81	1	8,350
271-283	290617	602,75	1	9,050
279-291	290618	602,75	1	9,050
292-304	290619	602,75	1	9,050
310-322	290620	643,49	1	9,740
320-332	290621	643,49	1	9,740
329-341	290622	643,49	1	9,740
338-350	290623	643,49	1	9,740
349-361	290624	643,49	1	9,740
359-371	290625	681,43	1	13,210
372-384	290626	681,43	1	13,210
379-391	290627	681,43	1	13,210
394-406	290628	681,43	1	13,210
403-415	290629	720,77	1	14,080
410-422	290630	925,90	1	14,080
419-431	290631	925,90	1	14,080
425-437	290632	925,90	1	14,080
433-445	290633	925,90	1	14,080
450-462	290634	1.035,49	1	15,970
467-479	290635	1.035,49	1	15,970
477-489	290636	1.035,49	1	15,970
487-499	290637	1.035,49	1	15,970
493-505	290638	1.035,49	1	15,970
504-520	290639	1.140,86	1	16,100
525-541	290640	1.140,86	1	16,100
539-555	290641	1.140,86	1	16,100

ACCESORIOS PARA OBRA CIVIL Y RIEGO

UNIÓN ARPOL EN ACERO INOXIDABLE  
PARA TUBERÍAS DE VARIOS MATERIALES

ANCHO DE UNIÓN 200 mm



Ø	REF.	EUROS	UNID. EMBALAJE	PESO UNID.
548-564	290642	1.140,86	1	16,890
557-573	290643	1.195,66	1	21,470
583-599	290644	1.195,66	1	21,470
599-615	290645	1.195,66	1	21,470
614-630	290646	1.250,45	1	21,470
630-646	290647	1.250,45	1	27,720
650-666	290648	1.250,45	1	27,720
676-692	290649	1.250,45	1	27,720
706-722	290650	1.360,04	1	27,720
719-735	290651	1.270,12	1	40,740
734-750	290652	1.413,43	1	40,740
744-760	290653	1.471,04	1	40,740
757-773	290654	1.986,67	1	40,740
767-783	290655	1.986,67	1	40,740
788-804	290656	1.986,67	1	40,740
808-824	290657	2.059,73	1	44,380
820-836	290658	2.059,73	1	44,380
837-853	290659	2.059,73	1	44,380
851-867	290660	2.132,79	1	44,380
866-882	290661	2.132,79	1	44,380
877-893	290662	2.132,79	1	44,380
900-916	290663	2.205,85	1	46,200
908-924	290664	2.205,85	1	46,200
921-937	290665	2.205,85	1	46,200
938-954	290666	2.205,85	1	46,200
957-973	290667	2.281,72	1	46,200
976-992	290668	2.281,72	1	46,200
987-1003	290669	2.281,72	1	46,200
1010-1026	290670	2.346,35	1	51,660
1042-1058	290671	2.346,35	1	51,660
1055-1071	290672	2.440,49	1	51,660
1078-1094	290673	2.440,49	1	51,660
1084-1100	290674	2.440,49	1	51,660
1097-1113	290675	2.440,49	1	51,660
1112-1128	290676	2.534,62	1	55,310
1124-1140	290677	2.534,62	1	55,310
1148-1164	290678	2.534,62	1	55,310
1172-1188	290679	2.632,97	1	55,310
1193-1209	290680	2.632,97	1	55,310
1208-1224	290681	2.734,13	1	55,310

Revisión A

ACCESORIOS PARA OBRA CIVIL Y RIEGO

ABRAZADERA DE REPARACIÓN 2 CIERRES

Revisión A



Ø	REF.	EUROS	UNID. EMBALAJE	PESO UNID.
140-160	380201	256,00	1	3,500
159-180	380202	260,06	1	3,600
165-185	380203	264,13	1	3,600
168-189	380204	268,19	1	3,650
170-190	380205	269,55	1	3,650
176-196	380206	270,90	1	3,700
190-210	380207	280,38	1	3,760
195-217	380208	288,51	1	3,760
210-230	380209	292,57	1	4,000
216-238	380210	310,18	1	4,000
225-246	380211	325,08	1	4,300
230-250	380212	327,79	1	4,350
240-260	380213	327,49	1	4,400
250-270	380214	332,30	1	4,550
269-289	380215	337,27	1	4,650
273-293	380216	338,63	1	4,650
282-302	380217	342,69	1	4,800
295-315	380218	346,75	1	4,800
299-330	380219	348,11	1	4,800
315-335	380220	348,11	1	4,950
322-344	380221	352,17	1	5,000
337-358	380222	354,88	1	5,200
347-367	380223	360,30	1	5,300
365-385	380224	364,36	1	5,400
382-402	380225	383,32	1	5,000
396-420	380226	387,39	1	5,500
410-430	380227	390,10	1	5,850
420-440	380228	391,45	1	5,900
435-455	380229	394,16	1	5,950



**ACCESORIOS PARA OBRA CIVIL Y RIEGO**
**ABRAZADERA DE REPARACIÓN 1 CIERRE**

Ø	REF.	EUROS	UNID. EMBALAJE	PESO UNID.
48-52	380101	100,23	1	1,000
54-58	380102	101,59	1	1,300
60-67	380103	104,30	1	1,350
67-74	380104	109,71	1	1,400
70-77	380105	116,49	1	1,450
73-80	380106	116,49	1	1,500
76-83	380107	116,49	1	1,500
82-89	380108	119,20	1	1,500
87-94	380109	119,20	1	1,500
91-98	380110	120,55	1	1,500
95-102	380111	123,26	1	1,500
98-108	380112	124,61	1	1,650
102-112	380113	125,97	1	1,650
106-116	380114	125,97	1	1,700
108-118	380115	127,32	1	1,700
113-123	380116	127,32	1	1,900
118-128	380117	130,03	1	1,900
120-131	380118	130,03	1	1,950
125-135	380119	131,39	1	1,950
132-142	380120	135,45	1	2,000
135-145	380121	139,51	1	2,000
145-155	380122	142,22	1	2,100
151-161	380123	149,00	1	2,100

Revisión A

ACCESORIOS PARA OBRA CIVIL Y RIEGO

**VENTOSA AUTOMÁTICA FUNDICIÓN DOBLE EFECTO GGG40**



DN	REF.	EUROS	UNID. EMBALAJE	PESO UNID.
50	670003	277,01	1	8,000
65	670008	336,24	1	10,000

**VENTOSA AUTOMÁTICA FUNDICIÓN TRIPLE EFECTO GGG40**

DN	REF.	EUROS	UNID. EMBALAJE	PESO UNID.
50	670103	400,71	1	9,000
65	670108	461,68	1	10,000

**VENTOSA AUTOMÁTICA DE POLIAMIDA DOBLE EFECTO**



DN	REF.	EUROS	UNID. EMBALAJE	PESO UNID.
32-1"	670009	20,91	1	0,300
60-2"	670010	36,59	1	0,800

**VENTOSA AUTOMÁTICA DE POLIAMIDA TRIPLE EFECTO**

DN	REF.	EUROS	UNID. EMBALAJE	PESO UNID.
32-1"	670011	52,27	1	0,400
60-2"	670012	95,82	1	0,900

Revisión A

## CONDICIONES GENERALES DE VENTA

### PRECIOS

La presente TARIFA anula y sustituye cualquier otro anterior. Así mismo, anula cualquier oferta personalizada anterior.

Las entregas de los pedidos se facturarán al precio en vigor en el momento del pedido.

Con el fin de evitar errores y poder tramitar correctamente, es importante que cada artículo esté acompañado de su correspondiente código identificativo, el cual está referenciado en esta misma tarifa.

### ÁMBITO

Las presentes condiciones de venta se aplicarán a todos los pedidos. Cualquier variación deberá haber sido expresamente aceptada por **BATERÍAS DEL SURESTE, S.L.U.**, vía fax, correo electrónico o carta.

### I.V.A.

No incluido. Se aplicará el tipo vigente.

### ENTREGA

La cumplimentación de los pedidos se realizará dentro de los tres días hábiles siguientes a la recepción del pedido, siempre y cuando los artículos sean los incluidos en el siguiente catálogo.

El plazo de entrega se considera hasta el momento de entrega de la mercancía a la agencia de transporte.

Todo artículo especial tiene un plazo de entrega máximo de 21 días tras la confirmación por escrito del pedido, mediante plano acotado y detallado, sellado o firmado.

### TRANSPORTE

Portes pagados a partir de 600 € netos de pedido. Para Península y Baleares.

Portes pagados a partir de 1.500 € netos de pedido. Para Canarias, Ceuta y Melilla.

Portes pagados a partir de 1.000 € netos de pedido. Para Portugal.

Las portes correspondientes a los envíos que soliciten URGENTES y que deban ser expedidos por otra Agencia de Transporte distinta a la que **BATERÍAS DEL SURESTE, S.L.U.** tiene contratada, correrán a cargo del consignatario.

Los pedidos por importe inferior al mínimo, se cargará el transporte en factura, descontando la parte proporcional al importe pedido en factura.

### CONDICIONES DE PAGO

Todo impuesto aplicable en el momento de facturación del pedido será por parte del comprador.

El plazo máximo de pago será de 45 días fecha factura.

El descuento aplicable para operaciones de contado o recibo domiciliado hasta 7 días es del 2%.

Así mismo, el comprador reembolsará al vendedor, en concepto de daños y perjuicios, las cargas bancarias y judiciales, devengadas a causa del impago de efectos.

## RECLAMACIONES Y DEVOLUCIONES

No se admitirán devoluciones ni reclamaciones transcurridos 15 días desde la fecha de recepción de la mercancía. En cualquier caso, las devoluciones de material deberán efectuarse en base a las siguientes normas:

- 1.- Toda devolución de mercancía deberá ser notificada previamente.
- 2.- Toda devolución aceptada deberá haber sido confirmada por escrito por parte de **BATERÍAS DEL SURESTE, S.L.U.**
- 3.- Toda devolución de material deberá ir acompañada de albarán del Sr. Cliente con especificación del material devuelto.
- 4.- En el albarán que acompaña la mercancía deberá reflejar claramente el Número de referencia de la aceptación por parte de **BATERÍAS DEL SURESTE, S.L.U.**
- 5.- En ningún caso se admitirán devoluciones de trabajos especiales que se ajusten a las características y planos solicitados por nuestros clientes.
- 6.- Toda mercancía devuelta debe venir a PORTES PAGADOS.
- 7.- En cualquier caso, no se admitirá mercancía que no se encuentre en perfecto estado. Se procederá a la devolución al cliente de dichos artículos.
- 8.- En caso de devolución por causas ajenas a **BATERÍAS DEL SURESTE, S.L.U.**, se realizará un cargo adicional del 2% en concepto de gastos de manipulación y gestión.
- 9.- Los abonos emitidos serán compensados con facturas posteriores.

En ningún caso **BATERÍAS DEL SURESTE, S.L.U.** se hará cargo de las devoluciones que no cumplan estas normas.

### GARANTÍA

La garantía de nuestros productos está limitada a 3 años, fecha de factura o documento de entrega, según Real Decreto Legislativo 7/2021 de 27 de abril, por el que se aprueba el texto consolidado de la modificación de la Ley General para la Defensa de los Consumidores y Usuarios y otras leyes complementarias, en su Artículo IV de Garantías y servicios postventa, en su Capítulo III, Ejercicio de derechos por el consumidor y usuario, en su Artículo 120, Plazo para la manifestación de la falta de conformidad, Punto 1 (BOE núm. 101, de 28-04-2021, pp. A-202-6872), salvo que se exprese de forma explícita, lo contrario.

Esta garantía puede sufrir variación, condicionada a futuras leyes o decretos.

**BATERÍAS DEL SURESTE, S.L.U.** garantiza todos los artículos de cualquier defecto de fabricación. Quedando limitada nuestra responsabilidad a la sustitución de la pieza defectuosa. Una vez que nuestro Departamento Técnico haya analizado y confirmado dicho defecto.

**BATERÍAS DEL SURESTE, S.L.U.** y el Cliente se someten para cualquier litigio a los Juzgados y Tribunales de Murcia.



### DATOS GPS

Formato Decimal: 37.998479, -1.088079

Formato Grados: 37° 59' 54.5244" Latitud

-1° 5' 17.0844" Longitud

MOD.BS TP 01.01.23 (A)



Revisión A

**23/01**



C/ Mayor, 250 - 30006 PUENTE TOCINOS - Murcia (Spain)

Telfs. 968 30 02 13 - 968 30 31 37 / Fax: 968 30 24 74

Web: [www.batsur.es](http://www.batsur.es) / E-mail: [batsur@batsur.es](mailto:batsur@batsur.es)



**BUREAU  
VERITAS**