



idrospania[®]

The logo for 'idrospania' features the brand name in a bold, italicized, blue sans-serif font. Below the text are two stylized, wavy blue lines that suggest water or a dynamic flow. The entire logo is set against a background of a water splash with many small, clear droplets.

CATÁLOGO
GENERAL. E.

MAYO
2023

PRESENTACIÓN 03

EQUIPAMIENTO WC 13

CISTERNAS EMPOTRADAS 13

CISTERNAS DE CRISTAL 23

ESTRUCTURAS BIDET 29

DESCARGADORES 31

REPUESTOS DESCARGADORES 43

MECANISMOS COMPLETOS 49

GRIFOS ALIMENTACIÓN 53

DUCHA-BIDET 65

CISTERNAS 75

CISTERNAS TANQUE ALTO COMPLETAS 77

CISTERNAS TANQUE ALTO 79

EQUIPAMIENTO TANQUE ALTO 81

ASIENTOS DE INODORO 83

ASIENTOS DE DUCHA 89

MANGUITOS 91

PIEZAS DE RECAMBIO 97

SIFONES Y VÁLVULAS 113

CLICK-CLACK Y SIFONES LATÓN 113

CLICK-CLACK Y SIFONES ACABADOS ESPECIALES 121

RECAMBIOS CLICK-CLACK Y SIFONES 127

LAVABO-BIDET 129

FREGADERO 133

DUCHA 141

BAÑERA 147

URINARIO 149

TUBOS FLEXIBLES 151

PIEZAS DE RECAMBIO 155

PRESENTACIÓN DE PRODUCTO 165

CONDICIONES GENERALES 169

ÍNDICE POR CÓDIGO 171

La empresa

A lo largo de los años en H & H Idrospania Technic, S.L. nos hemos consolidado como una empresa líder en el sector de equipamiento de fontanería. La alta calidad de nuestros productos, el inmejorable servicio y la profesionalidad del equipo humano que hay detrás de todo el proceso, tienen como resultado el reconocimiento de la empresa como una marca de prestigio que cuenta con la certificación de calidad ISO 9001:2015.

La implicación absoluta de todo el equipo de H & H Idrospania Technic, S.L. ha sido clave para llevar a la empresa al más alto nivel posible. Nos hemos adaptado rápidamente a las exigencias de los mercados tanto nacionales como internacionales, para ofrecer un producto fiable, de calidad y que protege el medio ambiente, utilizando materias primas de primera calidad y maquinaria de última tecnología.

En H.&H. Idrospania Technic S.L. estamos concienciados con la importancia de ser respetuosos con el medio ambiente, por ello la política medioambiental de la empresa va dirigida al consumo eficiente de agua. Contamos con una amplia gama de productos que ofrecen la posibilidad de interrumpir la descarga, o bien elegir una descarga de 3 o 6 litros dejando el control del consumo y el ahorro en manos del consumidor final. Para nosotros, la confianza y satisfacción de los clientes es el resultado de proporcionar un trabajo ágil, profesional y personalizado, que en conjunto con nuestros productos de fácil instalación y larga durabilidad, nos ha llevado a ser un referente en el sector.





idrospania

idrospania
H. & H.
IDROSPANIA
TECHNIC S.L.

idrospania



MATERIA PRIMA



PLANTA DE INYECCIÓN

Fabricación

En nuestras instalaciones disponemos de la última tecnología de fabricación de piezas plásticas. Contamos con maquinaria de inyección de plástico moderna, y todos nuestros productos se fabrican mediante una materia prima de alta calidad.



PIEZAS INYECTADAS

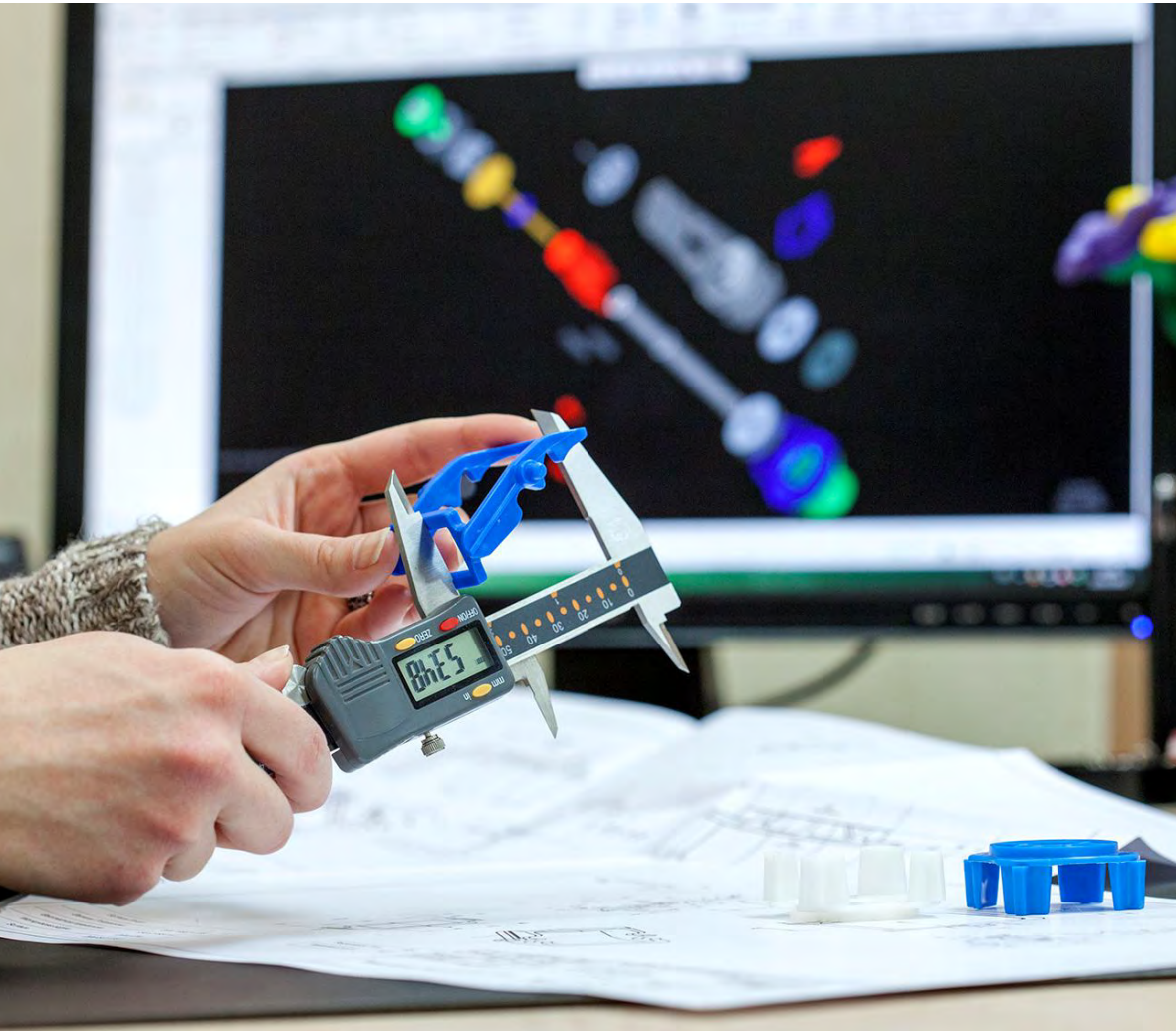

I+D+i



LABORATORIO

Calidad

Nuestro compromiso con la calidad se ve reflejado en cada uno de los procesos de producción, controlando cada etapa durante la fabricación de nuestros productos desde la llegada de las materias primas hasta el embalaje final.

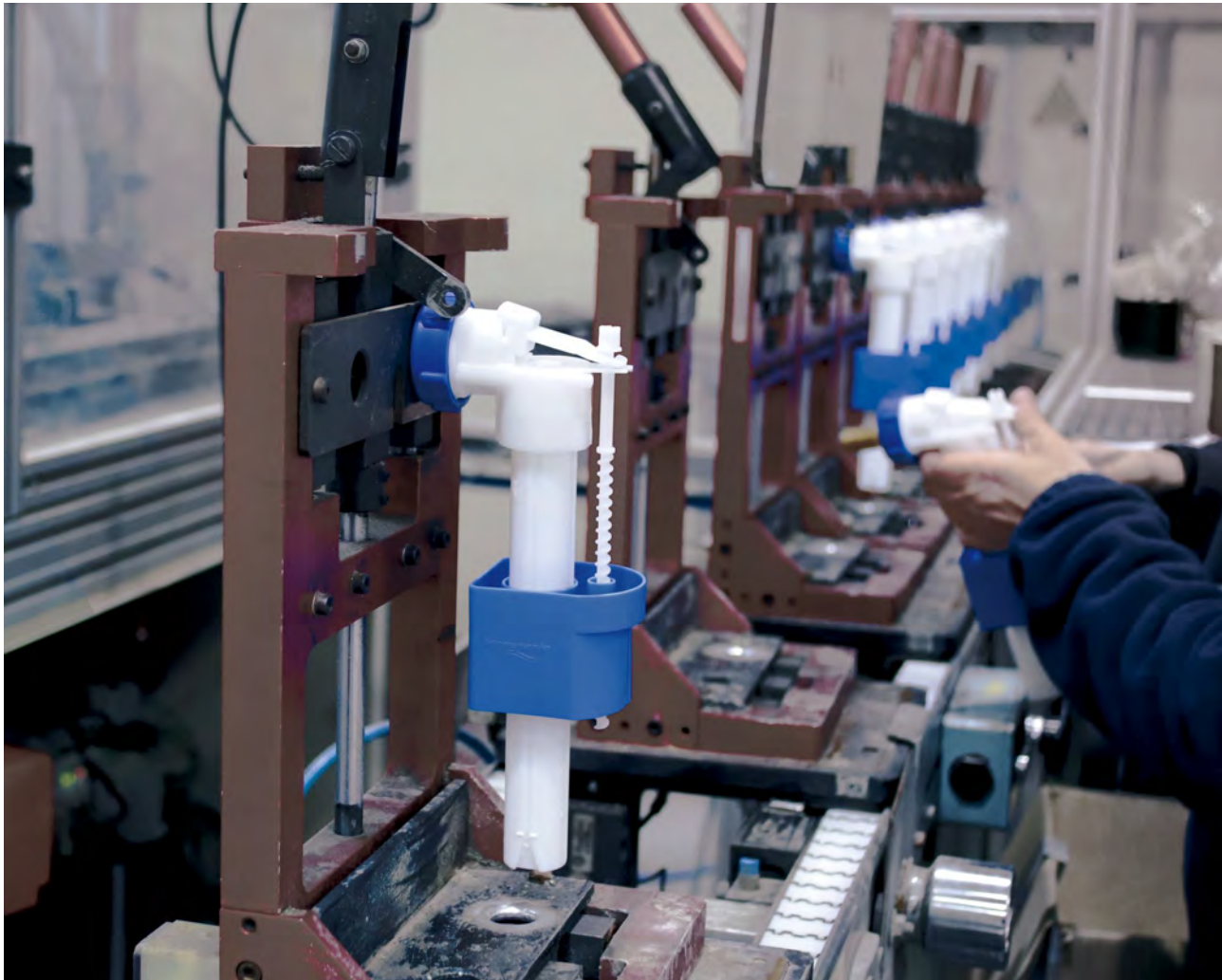

ESTACIÓN DE COMPROBADO GRIFOS SERVO

A través de una apuesta fuerte y gran inversión, tanto en recursos humanos como en equipamiento de control, garantizamos un producto de calidad, duradero y que cumpla con las expectativas de nuestros clientes.

Consecuencia de esta búsqueda constante de la mejora continua, no solo en los productos sino también en la gestión de la calidad, son los diferentes certificados de calidad como el ISO 9001:2015.



LÍNEA DE MONTAJE AUTOMÁTICO



EMBOLSADO FLOW-PACK

Logística

En nuestro almacén de expediciones disponemos de un amplio stock para dar una respuesta rápida y un servicio satisfactorio a nuestros clientes, reduciendo al mínimo los tiempos de entrega.



ALMACÉN



THE INTERNATIONAL CERTIFICATION NETWORK

CERTIFICATE

IQNet and
AENOR
hereby certify that the organization

H. & H. IDROSPANIA TECHNIC, S.L.

PARQUE EMPRESARIAL CARABONA, AV DE L'ARGENT, PARCELA M-3.
12530 - BURRIANA
(CASTELLON)

for the following field of activities

The design, production and sale by plastic injection of hydrosanitary products.

has implemented and maintains a

Quality Management System

which fulfills the requirements of the following standard

ISO 9001:2015

First issued on: 2017-09-28

Validity date: 2020-09-28

Registration Number: **ES-0506/2017**



Michael Drechsel
President of IQNet

Rafael Garcia
Chief Executive Officer

AENOR

Original Electronic Certificate

IQNet Partners:

AENOR Spain AFNOR Certification France AIB-Vincotte International Belgium ANCE Mexico APCER Portugal CCC Cyprus
CISQ Italy CQC China CQM China CQS Czech Republic Cro Cert Croatia DQS Holding GmbH Germany
ECAV Brazil FONDONORMA Venezuela ICONTEC Colombia IMNC Mexico Inspecta Certification Finland IRAM Argentina
JQA Japan KIQ Korea MIRTEC Greece MSZT Hungary Nemko AS Norway NSAI Ireland PCBC Poland
Quality Austria Austria RR Russia SII Israel SIQ Slovenia SIRIM QAS International Malaysia
SQS Switzerland SRAC Romania TEST St Petersburg Russia TSE Turkey YUQS Serbia
IQNet is represented in the USA by: AFNOR Certification, CISQ, DQS Holding GmbH and NSAI Inc.

* The list of IQNet partners is valid at the time of issue of this certificate. Updated information is available under www.iqnet-certification.com

CERTIFICAT

COMPOSANTS SANITAIRES

Le CSTB atteste que les produits, mentionnés en annexe, sont conformes à des caractéristiques décrites dans le référentiel de certification de la marque NF 076 (révision n° 9) après évaluation selon les modalités de contrôle définies dans ce référentiel.

En vertu de la présente décision notifiée par le CSTB, AFNOR Certification accorde à :

La société H.&H. IDROSPANIA TECHNIC, S.L.
Parque Empresarial carabona
Avda. L'argent Parcela M-3
ES-12530 Burriana (CASTELLON)

Usine de ES-12530 Burriana (CASTELLON)

le droit d'usage de la marque NF COMPOSANTS SANITAIRES pour les produits objets de cette décision, pour toute la durée de validité et dans les conditions prévues par les règles générales de la marque NF et le référentiel mentionné ci-dessus.

Décision de reconduction n° 236-U1-17/2 du 12 juillet 2017

Cette décision annule et remplace toute décision antérieure

Sauf retrait, suspension ou modification, ce certificat est valable pendant 15 mois. Le certificat en vigueur peut être consulté sur le site internet evaluation.cstb.fr pour en vérifier sa validité.

CARACTÉRISTIQUES CERTIFIÉES

Les produits bénéficiaires du droit d'usage de la marque NF COMPOSANTS SANITAIRES possèdent les caractéristiques minimales exigées par les normes suivantes, éventuellement complétées par les spécifications techniques :

NF 076 - DOC TECH 3

Ce certificat comporte : 2 pages

Correspondant

Stéphane FATIS

Tél. : (33) 01 64 68 88 60

Fax : (33) 01 64 68 84 44

Email : stephane.fatis@cstb.fr

Pour le CSTB
Pour le Directeur Technique

Yannick LEMOIGNE



ACCREDITATION
N° 5-0010
PORTÉE
DISPONIBLE SUR
WWW.COFRAC.FR
CENTRE FRANÇAIS
DE PRODUITS
ET SERVICES

NORMATIVA NF

PARA MECANISMOS DE DESCARGA Y GRIFOS FLOTADOR NF076

MECANISMOS DE DESCARGA

- CAUDAL DE DESCARGA: $\geq 2,2$ L / s en descarga total y 2,5 L/s en medio rasante.
- CAUDAL MÍNIMO DE DESBORDAMIENTO: en caso de llenado continuo del tanque, el tubo rebosadero garantiza la total evacuación del agua sin desbordamiento de la cisterna.
- RESISTENCIA: 200.000 ciclos mínimo.
- FUERZA DE ACCIONAMIENTO: <2 kg.
- ESTANQUEIDAD de la junta de cierre.

GRIFOS FLOTADOR

- CONFORT ACÚSTICO (clase 1: menos de 20 decibelios, clase 2: <20 a 30 decibelios).
- VELOCIDAD DE LLENADO: 3 L / min a 0,5 bar.
El caudal mínimo a 3 bares es de 12 L / min.
- Sistema anti-golpes al cierre.
- PRESIÓN: opera de 0,5 a 10 bares.
- ANTI-RETORNO: garantiza que no se devuelva el agua del tanque al circuito de agua potable de la vivienda.
- RESISTENCIA: 200.000 ciclos mínimo.

idrospania®



MADE IN SPAIN

H. & H. IDROSPANIA TECHNIC S.L.

Avda. de L'Argent, Parcela M-3 P.O. Box 371

BURRIANA (Castellón) SPAIN

Tel. (+34) 902 19 19 77

Fax. (+34) 902 19 19 79

E-mail: idrospania@idrospania.com

www.idrospania.com

Aviso legal:

idrospania® es una marca registrada española protegida por la ley.

Serán tomadas acciones legales contra cualquier falsificación, imitación

o colocación indebida de la marca: *idrospania*® en los productos.



CISTERNAS EMPOTRADAS

Mod. Menorca



Cod.		€
40220	Cisterna empotrada mecanismo cable de doble descarga con estructura metálica, para inodoros suspendidos	259,00



- Doble descarga
- Testado x200.000
- Espesor 9cm
- Llenado silencioso
- Resistencia
- Cisterna plástico fabricada en una sola pieza

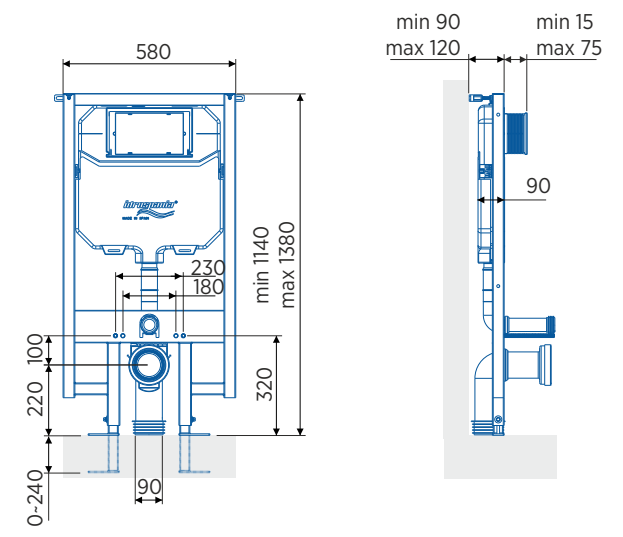

CISTERNAS EMPOTRADAS

EQUIPAMIENTO WC

Mod. Tabarca

CONSULTA VÍDEO
INSTALACIÓN



Cod.		€
40230	Cisterna empotrada mecanismo cable de doble descarga con estructura metálica, para inodoros suspendidos	229,00



Doble descarga



Testado x200.000



Espesor 9cm



Llenado silencioso



Resistencia

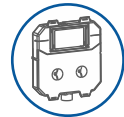

Cisterna plástica fabricada en una sola pieza

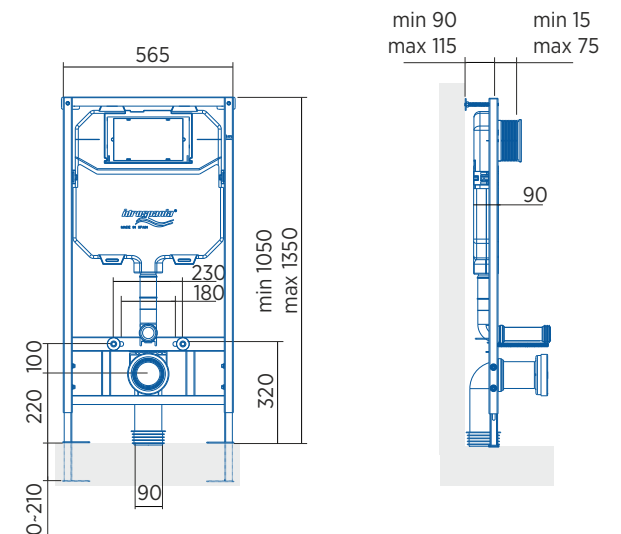

MADE IN SPAIN



Mod. Málaga



Cod.		€
40240	Cisterna empotrada mecanismo cable de doble descarga con estructura metálica, para inodoros suspendidos	178,00

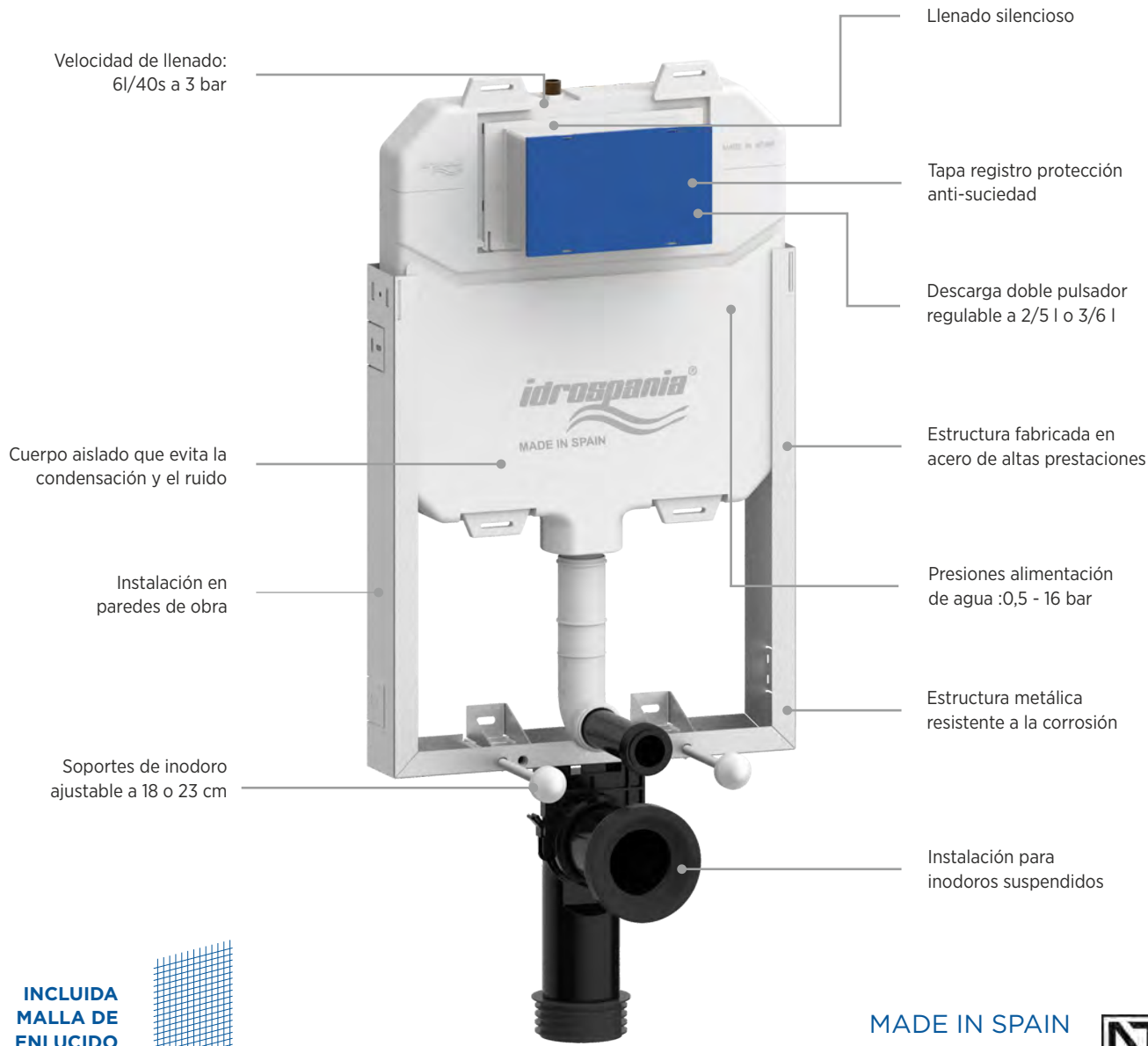

- Doble descarga
- Testado x200.000
- Espesor 9cm
- Llenado silencioso
- Resistencia
- Cisterna plástico fabricada en una sola pieza

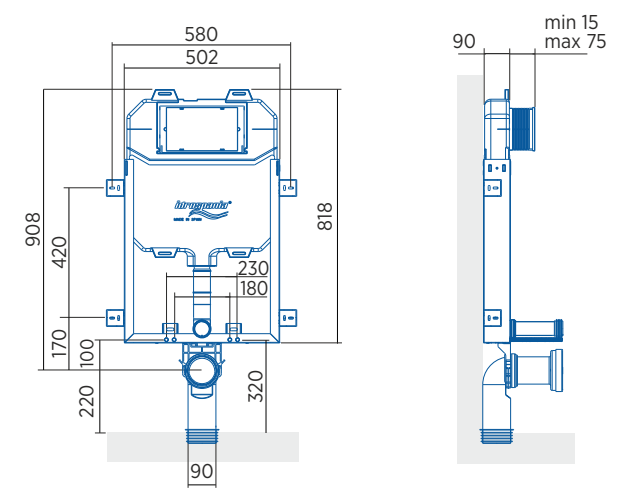

INCLUIDA
MALLA DE
ENLUCIDO

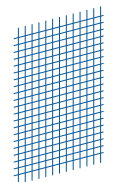

MADE IN SPAIN

CE CUMPLE NORMATIVA UNE-EN 14055 EN 14124

AENOR CONEXIONES FLEXIBLES

Mod. Marbella

Cod.		€
40320	Cisterna empotrada mecanismo cable de doble descarga, para inodoros a suelo	142,00

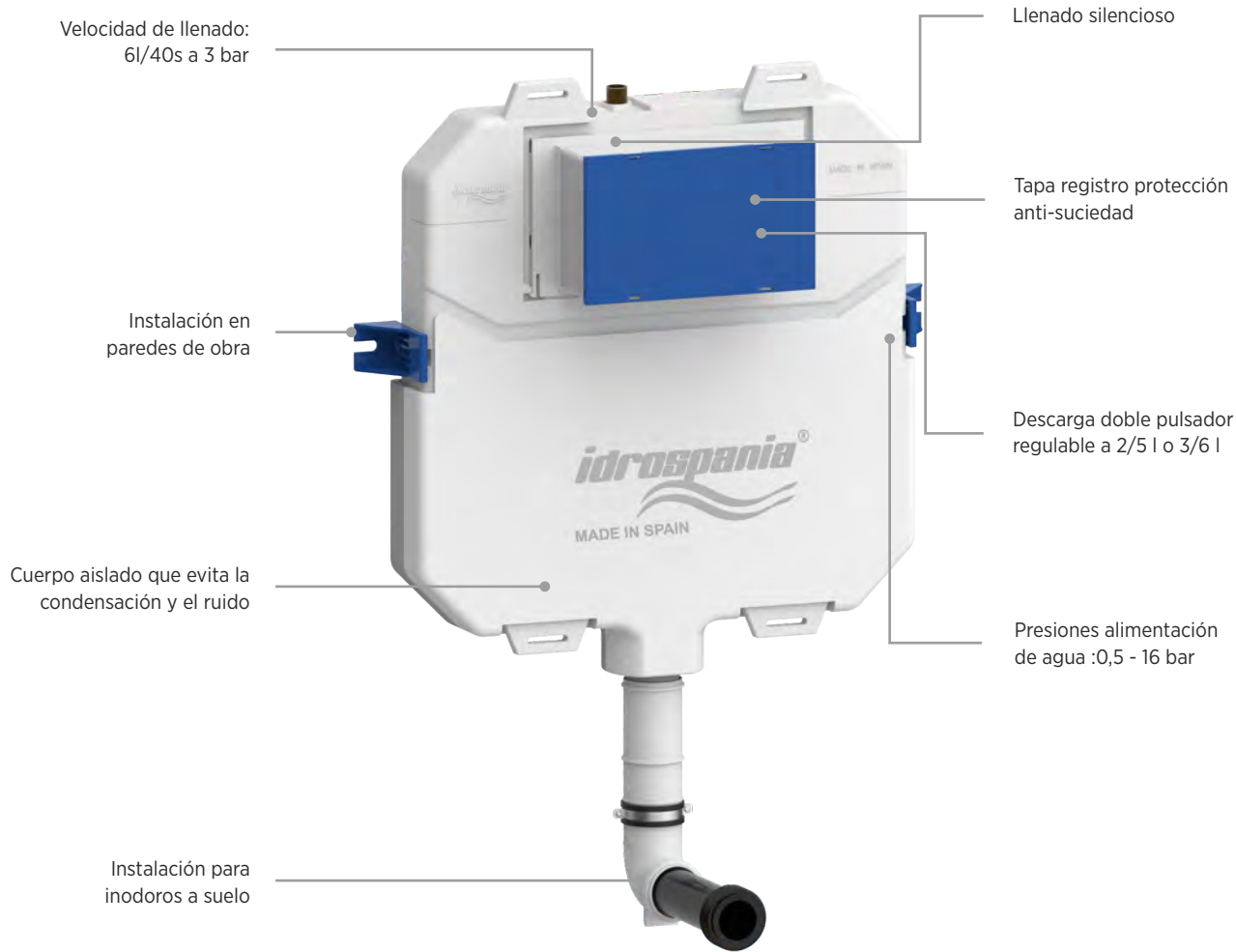

Doble descarga



Testado x200.000



Espesor 8,5cm



Llenado silencioso

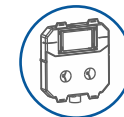

Cisterna plástica fabricada en una sola pieza



Para inodoro a suelo

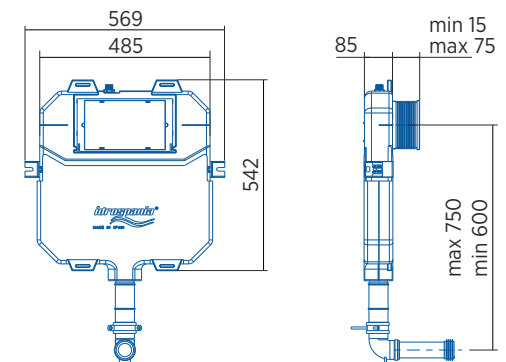

INCLUIDA MALLA DE ENLUCIDO

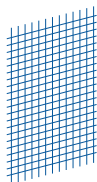

MADE IN SPAIN



Mod. Andrea



30350
ABS Blanco brillo
25,90€

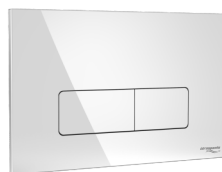

30351
ABS Cromo brillo
35,90€



30356
ABS Blanco mate
33,50€

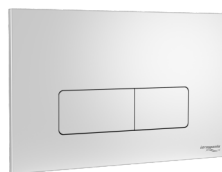

30352
ABS Cromo mate
39,90€



30354
ABS Negro mate
33,50€



30355
ABS Negro mate/ Cromo mate
35,90€



30357.10
ABS Cobre
40,70€

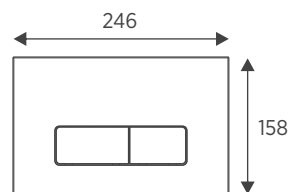

Mod. Belén



30360
ABS Blanco brillo
25,90€

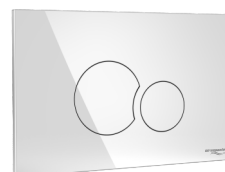

30361
ABS Cromo brillo
35,90€



30366
ABS Blanco mate
33,50€

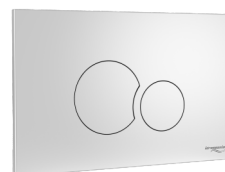

30362
ABS Cromo mate
39,90€



30364
ABS Negro mate
33,50€



30365
ABS Negro mate/ Cromo mate
35,90€

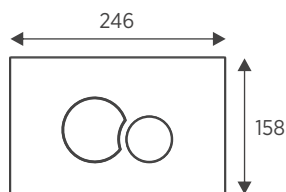

Mod. Noelia

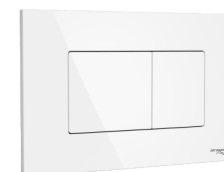

30370
ABS Blanco brillo
25,90€

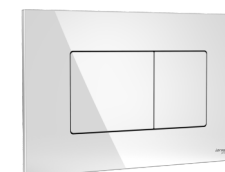

30371
ABS Cromo brillo
35,90€

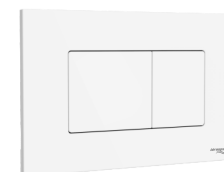

30376
ABS Blanco mate
33,50€

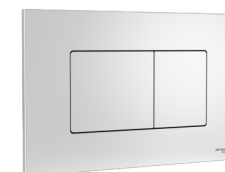

30372
ABS Cromo mate
39,90€



30374
ABS Negro mate
33,50€

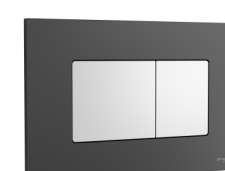

30375
ABS Negro mate/ Cromo mate
35,90€

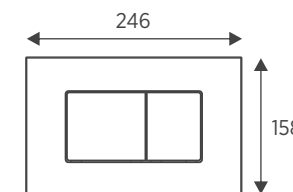

OPCIÓN .10 PULSADORES NEUTROS ANÓNIMOS
SIN GRABAR

RECAMBIOS CISTERNAS EMPOTRADAS EQUIPAMIENTO WC

RECAMBIOS PARA CISTERNAS EMPOTRADAS

Cod.	€
 30480 Mecanismo descargador	13,50
 30481 Grifo de alimentación	12,50
 30482 Latiguillo de alimentación	7,20
 30483 Llave de paso	8,60
 30484 Kit de herrajes de fijación Mod. 40220	9,70
 30497 Kit de herrajes de fijación Mod. 40230	6,55
 30498 Kit de herrajes de fijación Mod. 40240	6,55
 30499 Kit de herrajes de fijación Mod. 40320	4,75

RECAMBIOS PARA PULSADORES CISTERNAS EMPOTRADAS

Cod.	€
 30493 Tornillos fijación pulsador	4,75
 30494 Flejes pulsador	4,75
 30495 Muelle pulsador	4,75

Cod.	€
 30485 Kit espárragos fijación inodoro	7,95
 30486 Manguito recto	7,35
 30487 Codo de evacuación 90°	7,85
 30488 Conjunto soporte de codo Mod. 40220, 40230 y 40240	2,95
 30489 Conjunto tubo recto de salida	3,85
 30490 Tapa anticondensación	3,95
 30491 Conjunto acordeon y tapa registro	5,95
 30492 Kit juntas de goma	7,95

RECAMBIOS CISTERNAS EMPOTRADAS EQUIPAMIENTO WC

PULSADORES PARA CISTERNAS EMPOTRADAS REF.40210

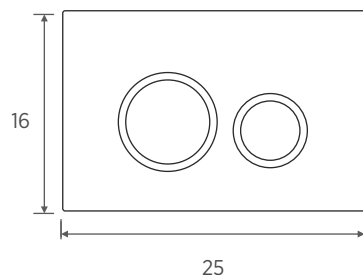

Cod.		€
30340	Placa de accionamiento doble pulsador mecánico ABS BLANCO / CROMO BRILLO	40,80

Cod.		€
30341	Placa de accionamiento doble pulsador mecánico ABS NEGRO / CROMO BRILLO	40,80

Cod.		€
30342	Placa de accionamiento doble pulsador mecánico ABS CROMO BRILLO / CROMO MATE	47,40

Cod.		€
30343	Placa de accionamiento doble pulsador mecánico ABS CROMO MATE / CROMO BRILLO	47,40

RECAMBIOS PARA CISTERNAS EMPOTRADAS REF.40210

Cod.		€
30436	Descargador completo cisterna empotrada	14,60
30423	Grifo alimentación cisterna empotrada	14,20
30433	Kit de conexión(manguitos) y fijación inodoro para cisternas empotradas	17,15



RECAMBIOS CISTERNAS EMPOTRADAS EQUIPAMIENTO WC

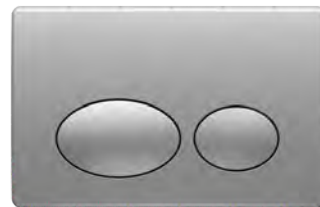
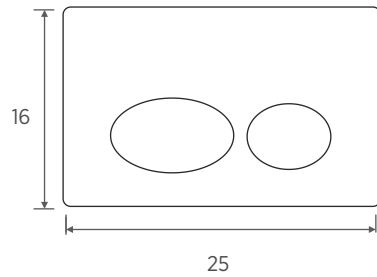

PULSADORES PARA CISTERNAS EMPOTRADAS REF.40200 / 40300

Cod.		€
30330	Placa de accionamiento doble pulsador mecánico ABS BLANCO	33,10

Cod.		€
30331	Placa de accionamiento doble pulsador mecánico ABS CROMO BRILLO	45,15

Cod.		€
30332	Placa de accionamiento doble pulsador mecánico ABS CROMO MATE	45,15

Cod.		€
30333	Placa de accionamiento doble pulsador mecánico ACERO INOX 304 BRILLO	172,00

RECAMBIOS PARA CISTERNAS EMPOTRADAS REF.40200 / 40300

Cod.		€
30412	Descargador completo cisterna empotrada	19,45

Cod.		€
30413	Grifo alimentación cisterna empotrada	19,45

CISTERNAS
VISTAS DE CRISTAL

CISTERNA VISTAS CRISTAL A SUELO
EQUIPAMIENTO WC



CISTERNAS VISTAS CRISTAL A SUELO EQUIPAMIENTO WC



Doble
descarga



Fácil y rápida
instalación



Cristal templado
6mm



Marco aluminio
resistente corrosión

C E CUMPLE
NORMATIVA
UNE-EN 14055

Cod.

€

40430

Cisterna vista WHITE compacta
para instalación de inodoros a suelo

360,00

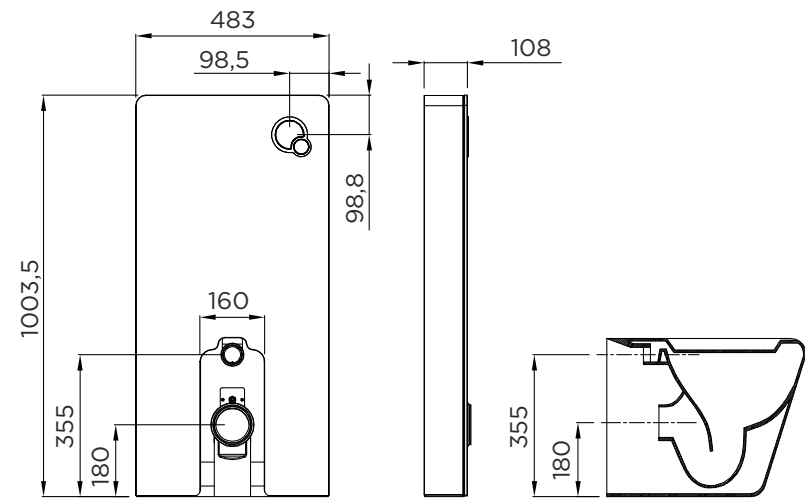

*Inodoro no incluido

Cod.

€

40420

Cisterna vista BLACK compacta
para instalación de inodoros a suelo

360,00

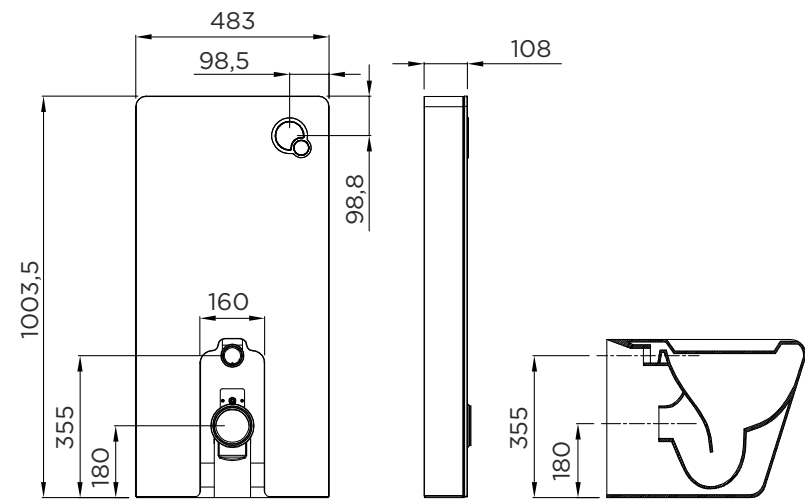

*Inodoro no incluido

CISTERNA VISTAS CRISTAL SUSPENDIDA
EQUIPAMIENTO WC



CISTERNAS VISTAS CRISTAL SUSPENDIDA

EQUIPAMIENTO WC



Doble
descarga



Fácil y rápida
instalación



Fijación magnética
tapa superior

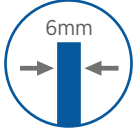

Cristal templado
6mm



Marco aluminio
resistente corrosión



Opción salida
horizontal y
vertical

CONSULTA VÍDEO
INSTALACIÓN



CE CUMPLE
NORMATIVA
UNE-EN 14055

Cod.

€

40410

Cisterna vista WHITE compacta
para instalación de inodoros suspendidos

395,00

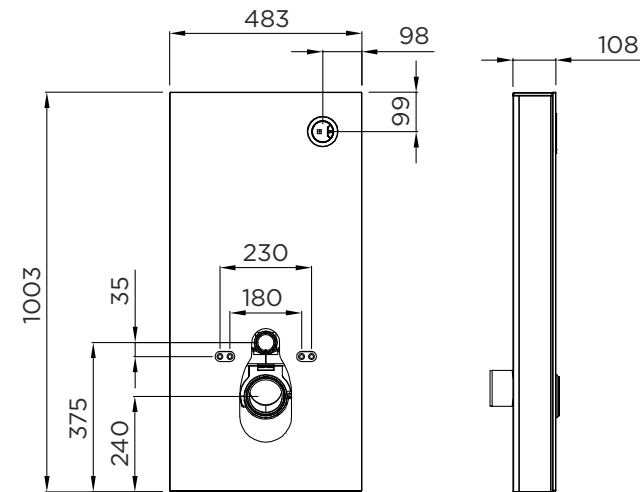

NOVEDAD Se incluye manguito para conexión vertical

*Inodoro no incluido

Cod.

€

40400

Cisterna vista BLACK compacta
para instalación de inodoros suspendidos

380,00

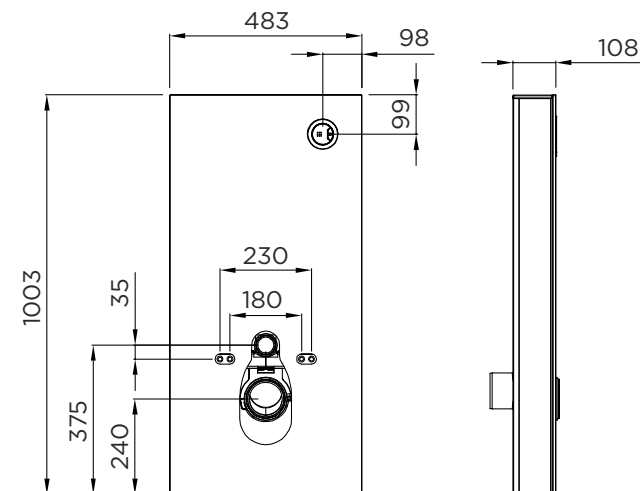

NOVEDAD Se incluye manguito para conexión vertical

*Inodoro no incluido





ESTRUCTURAS DE BIDET

Cod.		€
40500	Estructura para bidet suspendido h 420 mm	108,90



- UNIVERSAL
- Soportes de bidet ajustables a 18 o 25 cm
- Tomas ajustables
- Posición entrada ajustable
- Codo salida bidet Ø30-46 HDPE
- Soportes de pie galvanizados ajustables en altura 0-20 cm
- Pintura electrostática

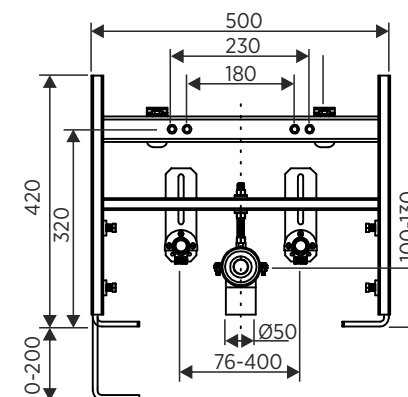

Cod.		€
40510	Estructura para bidet suspendido h 820 mm	141,75



- UNIVERSAL
- Incluye accesorios de fijación a suelo y pared
- Tomas ajustables
- Rosca tornillos M12 para una instalación rápida
- Posición entrada ajustable
- Soportes de pie galvanizados ajustables en altura 0-20 cm
- Codo salida bidet Ø30-46 HDPE
- Soportes de bidet ajustables a 18 o 25 cm
- Pintura electrostática

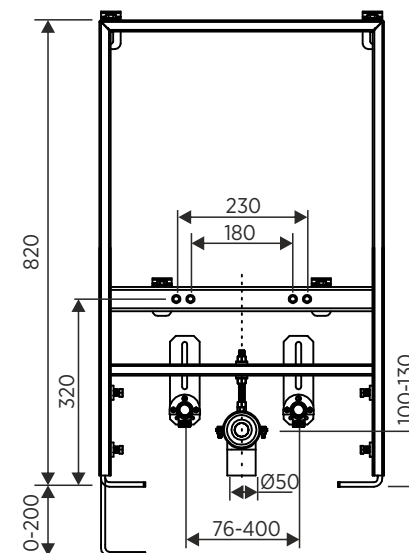

DESCARGADORES



Máxima adaptabilidad



Descarga interrumpible

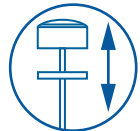

Pulsador ajustable en altura



Instalación sin necesidad de herramientas



Fácil y rápida instalación



Instalación sin necesidad de desmontar la cisterna

CONSULTA VÍDEO INSTALACIÓN



mod. LOJA

DESCARGADORES EQUIPAMIENTO WC

FÁCIL Y RÁPIDA INSTALACIÓN

Sin necesidad de herramientas

DESCARGA INTERRUPTIBLE

AHORRO DE CONSUMO DE AGUA

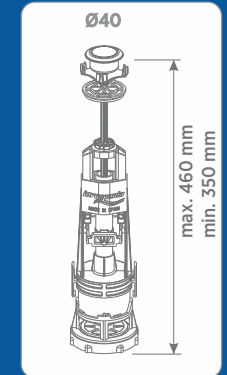
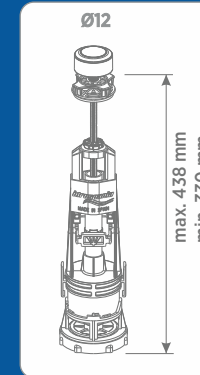

UNIVERSAL

Compatible con diámetros a partir de 12 mm

MÁXIMA ADAPTABILIDAD



MONTAJE EN CISTERNAS MODELO VICTORIA Y SIMILARES



No se utiliza ni el tornillo ni la tuerca de regulación

AGUJERO DE TAPA ENRASADO Ø40 Y RESALTADO Ø12

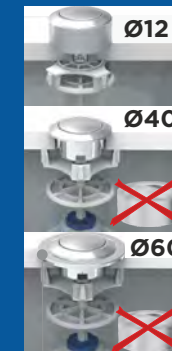

GOMA CIERRE CAUCHO



DESCARGADORES EQUIPAMIENTO WC

mod. LOJA

Descargador **INTERRUMPIBLE**
Con base roscada, base bayoneta y
goma de asiento.
mod. LOJA

Cod.	Emb.	€	
51010	BOLSA	16,50	25
51012	CAJA	17,85	16
 51010.1	BOX BOLSA	16,50	60
 51012.1	BOX CAJA	17,85	48

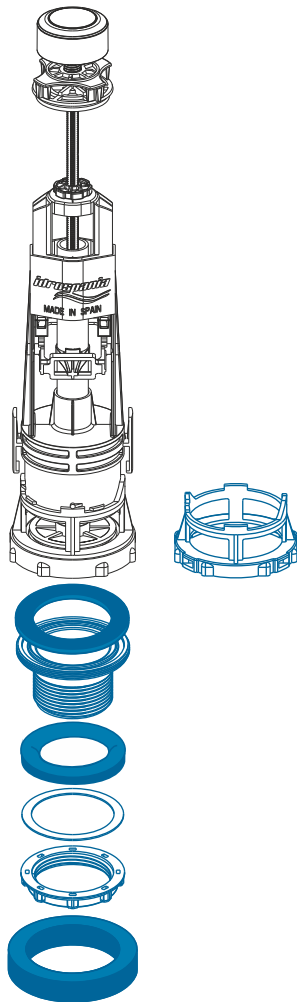

Descargador **INTERRUMPIBLE**
Sin base roscada y con base bayoneta.
mod. LOJA

Cod.	Emb.	€	
51011	BOLSA	14,90	32
51021	CAJA	16,30	16

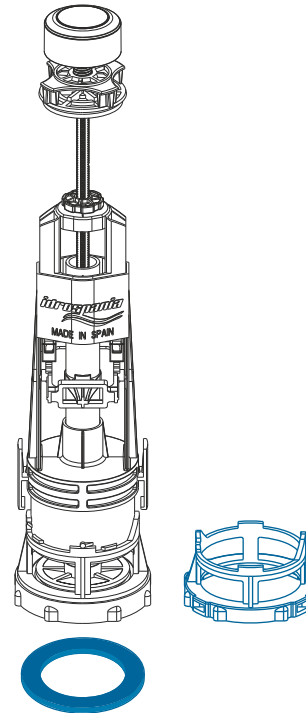

Descargador **INTERRUMPIBLE**
Con base roscada, base bayoneta, con tornillos
taza tanque HB y goma de asiento.
mod. LOJA

Cod.	Emb.	€	
51014	BOLSA	19,80	25
51015	CAJA	21,15	16

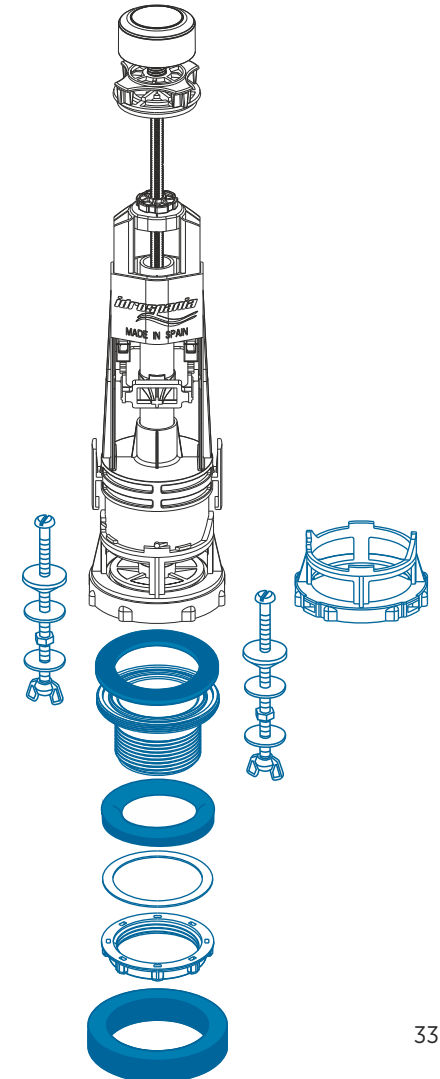



Máxima adaptabilidad



Doble descarga



Fácil y rápida instalación



Instalación sin necesidad de desmontar la cisterna

CONSULTA VÍDEO INSTALACIÓN



Pulsador easy-click



Cable de ACERO INOXIDABLE y terminales de LATÓN

mod. DENIA

DESCARGADORES EQUIPAMIENTO WC

FÁCIL Y RÁPIDA INSTALACIÓN

El sistema de cable facilita el montaje
El pulsador se puede colocar en la parte superior, lateral o frontal de la cisterna

DOBLE PULSADOR CON CABLE

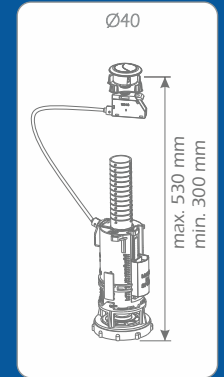
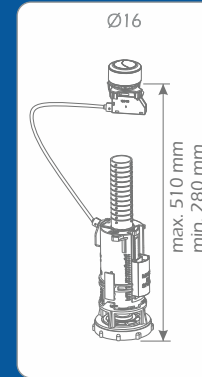

UNIVERSAL

Cubre todas las excentricidades de las cisternas

MÁXIMA ADAPTABILIDAD



1.- REGULACIÓN DESCARGA PARCIAL

La boya en la posición más alta indica menor descarga parcial, MÁS AHORRO

2.- REGULACIÓN DEL RESIDUAL

Posición 1: Residual mín. / Posición 4: Residual máx.
Residual: Cantidad de agua restante después de la descarga total

AGUJERO DE TAPA ENRASADO Ø40 Y RESALTADO Ø16

GOMA CIERRE CAUCHO



Adaptador 30319 (pág 99)

DESCARGADORES

EQUIPAMIENTO WC

Descargador doble pulsador de **CABLE**
Con base roscada, base bayoneta y
goma de asiento.
 mod. DENIA

Cod.	Emb.	€	
53010	BOLSA	20,10	25
53012	CAJA	21,60	16
 53010.1	BOX BOLSA	20,10	55
 53012.1	BOX CAJA	21,60	48

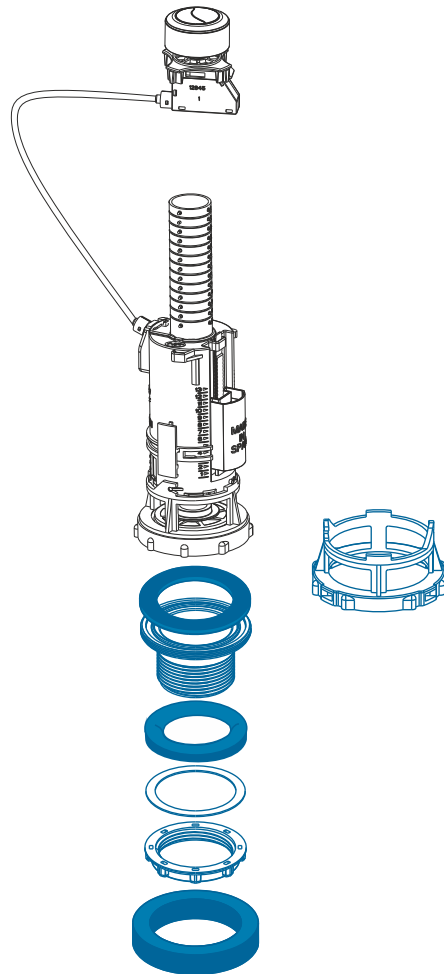

mod. DENIA

Descargador doble pulsador de **CABLE**
Sin base roscada y con base bayoneta.
 mod. DENIA

Cod.	Emb.	€	
53011	BOLSA	17,95	32
53021	CAJA	19,35	16

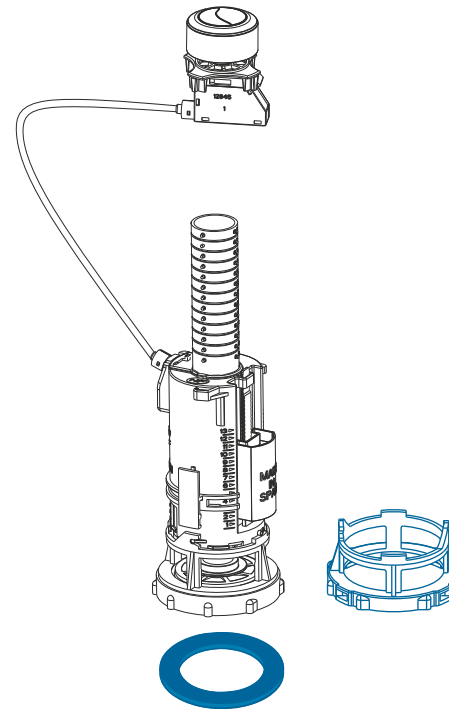

Descargador doble pulsador de **CABLE**,
Con base roscada, base bayoneta, con
tornillos taza tanque HB y goma de
asiento.
 mod. DENIA

Cod.	Emb.	€	
53014	BOLSA	23,10	25
53015	CAJA	24,25	16

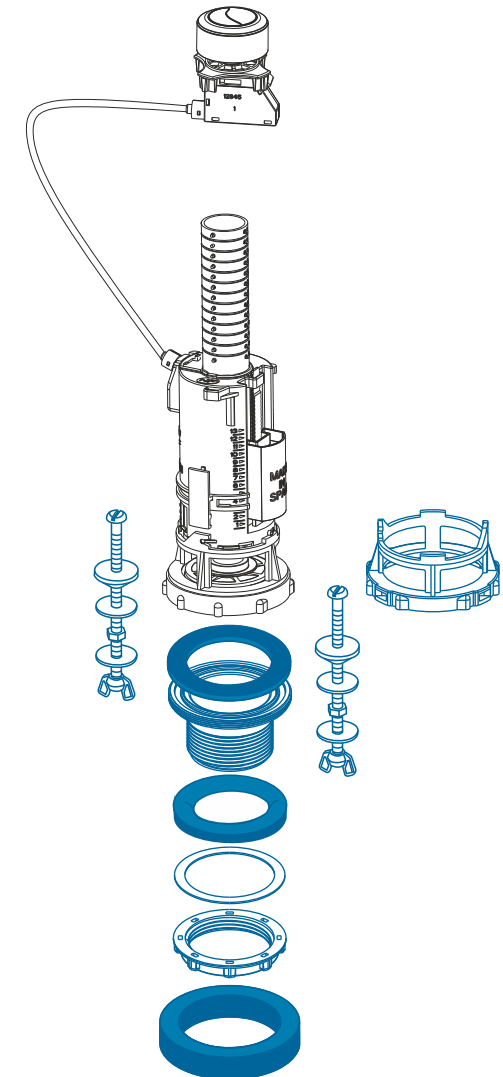



Fijación a la tapa
ANTIVANDÁLICO





Doble
descarga



Fácil y rápida
instalación



Instalación sin
necesidad de
desmontar la
cisterna

- Pulsador
easy-click
- 1 
 - 2 
 - 3  **click!**
- Cable de ACERO
INOXIDABLE y
terminales de
LATÓN

Fabricado con materiales plásticos de alta calidad y anticalcáreos
UN DESCARGADOR UNIVERSAL Y ANTIVANDÁLICO PARA TODOS
LOS MODELOS DE CISTERNAS CERÁMICAS

mod. DENIA PLUS

DESCARGADORES EQUIPAMIENTO WC

FÁCIL Y RÁPIDA INSTALACIÓN

El sistema de cable facilita el montaje

DOBLE PULSADOR CON CABLE



UNIVERSAL

Cubre todas las excentricidades de las cisternas

ANTIVANDÁLICO

Gracias al sistema de bloqueo a la tapa de la cisterna

ADAPTABLE AL SISTEMA TRADICIONAL

ADAPTABLE AL SISTEMA ACTUAL (BASES GRIS Y BLANCA)



1.- REGULACIÓN DESCARGA PARCIAL

La boya en la posición más alta indica menor descarga parcial, MÁS AHORRO

2.- REGULACIÓN DEL RESIDUAL

Posición 1: Residual mín. / Posición 4: Residual máx.
Residual: Cantidad de agua restante después de la descarga total

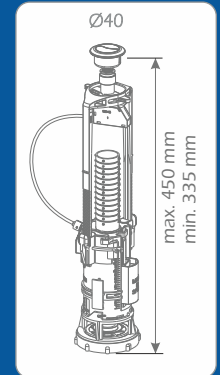
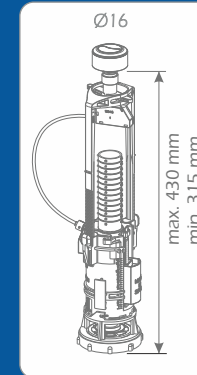
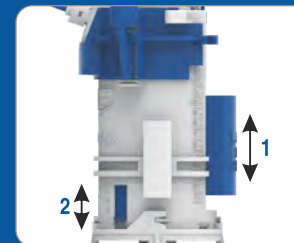

AGUJERO DE TAPA ENRASADO Ø40 Y RESULTADO Ø16

GOMA CIERRE CAUCHO



Adaptador 30319 (pág 99)



DESCARGADORES EQUIPAMIENTO WC

mod. DENIA PLUS

Descargador pulsador de **CABLE** de doble descarga **antivandálico (fijación a la tapa) con base y goma de asiento.**
mod. DENIA PLUS

Cod.	Emb.	€	
56010	BOLSA	20,70	14
56012	CAJA	22,00	12

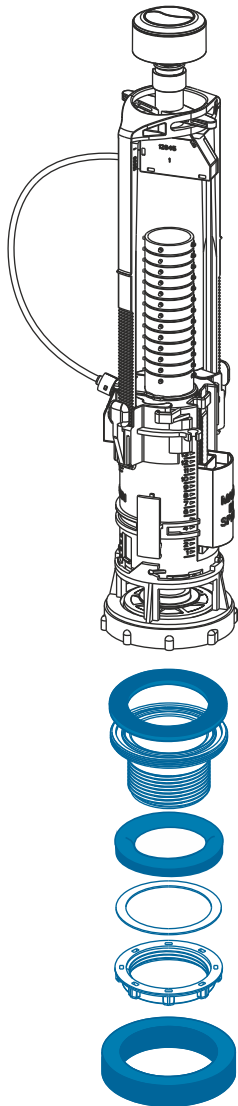

Descargador pulsador de **CABLE** de doble descarga **antivandálico (fijación a la tapa) sin base.**
mod. DENIA PLUS

Cod.	Emb.	€	
56011	BOLSA	18,70	18
56021	CAJA	20,00	12

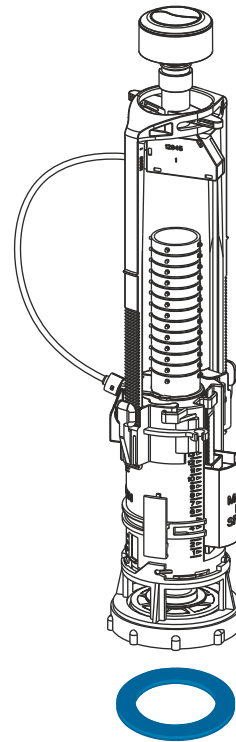

Descargador pulsador de **CABLE** de doble descarga **antivandálico (fijación a la tapa) con base con tornillos taza tanque y goma de asiento.**
mod. DENIA PLUS

Cod.	Emb.	€	
56014	BOLSA	23,50	14
56015	CAJA	24,85	12

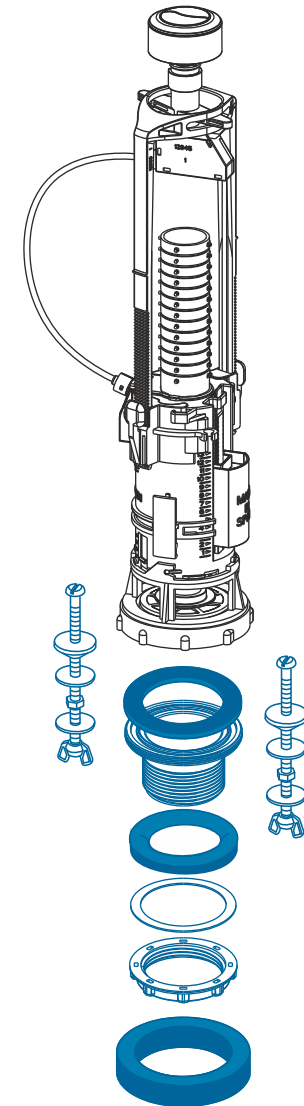



Fijación a la tapa
ANTIVANDÁLICO



Doble
descarga



Fácil y rápida
instalación



Instalación sin
necesidad de
desmontar la
cisterna

mod. PALMA

DESCARGADORES EQUIPAMIENTO WC

FÁCIL Y RÁPIDA INSTALACIÓN

Con sistema de fijación a la tapa

DOBLE PULSADOR



UNIVERSAL

Compatible con el sistema tradicional de rosca

ANTIVANDÁLICO

Gracias al sistema de bloqueo a la tapa de la cisterna

ADAPTABLE AL SISTEMA TRADICIONAL



1.- REGULACIÓN DESCARGA PARCIAL

La boya en la posición más alta indica menor
descarga parcial, MÁS AHORRO

2.- REGULACIÓN DEL RESIDUAL

Posición 1: Residual mín. / Posición 4: Residual máx.
Residual: Cantidad de agua restante después de la
descarga total

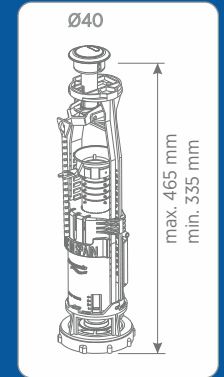
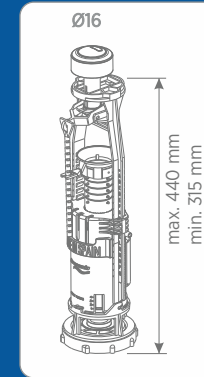
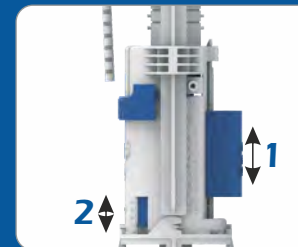

AGUJERO DE TAPA
ENRASADO Ø40 Y
RESALTADO Ø16

GOMA CIERRE
CAUCHO



DESCARGADORES EQUIPAMIENTO WC

Descargador doble de pulsador mecánico,
**Antivandálico (fijación a la tapa) con base
y goma de asiento.**
mod. PALMA

Cod.	Emb.	€	
22010	BOLSA	16,30	20

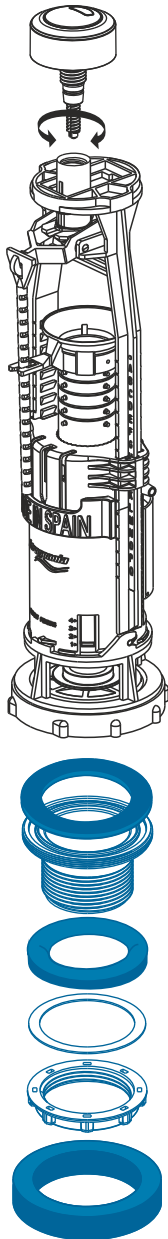

mod. PALMA

Descargador doble de pulsador mecánico,
Antivandálico (fijación a la tapa) sin base.
mod. PALMA

Cod.	Emb.	€	
22011	BOLSA	14,00	25

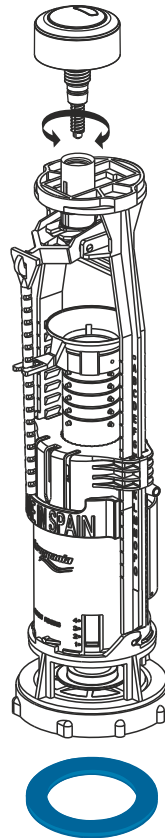

Descargador doble de pulsador mecánico,
**Antivandálico (fijación a la tapa) con base
con tornillos taza tanque y goma de asiento.**
mod. PALMA

Cod.	Emb.	€	
22014	BOLSA	20,10	20

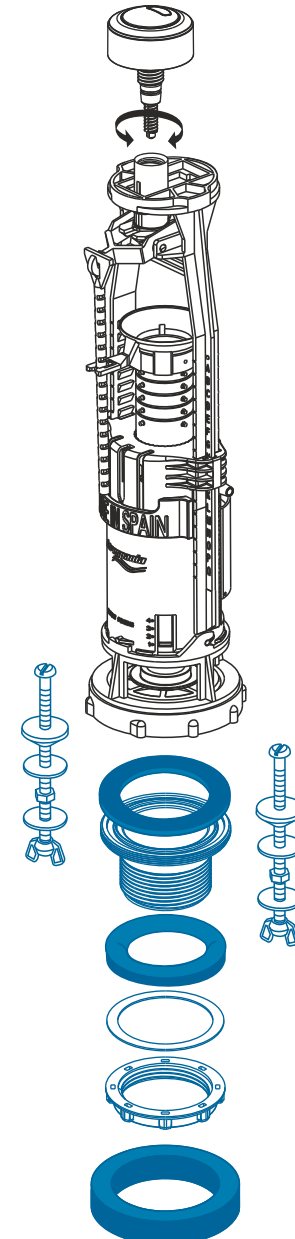



Pulsador easy-click



Cable de ACERO INOXIDABLE y terminales de LATÓN



Descarga simple



Fácil y rápida instalación

mod. JAVEA

DESCARGADORES EQUIPAMIENTO WC

FÁCIL Y RÁPIDA INSTALACIÓN

GOMA CIERRE CAUCHO

DESCARGA SIMPLE



UNIVERSAL

Cubre todas las excentricidades de las cisternas

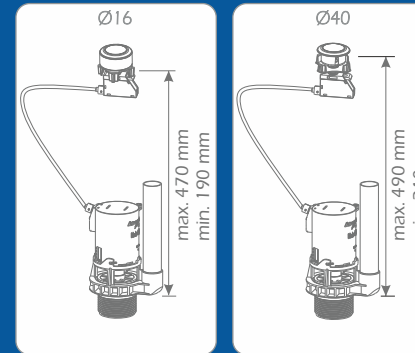

BASE UNIVERSAL COMPACTA



AGUJERO DE TAPA ENRASADO Ø40 Y RESULTADO Ø16



Adaptador 30319 (pág 99)

Descargador COMPACTO SIMPLE de CABLE, Con base universal compacta y goma de asiento. mod. JAVEA

Cod.	Emb.	€	
54000	BOLSA	15,40	22

Descargador COMPACTO SIMPLE de CABLE, Con base universal compacta, tornillos taza-tanque HB y goma de asiento. mod. JAVEA

Cod.	Emb.	€	
54004	BOLSA	18,35	22

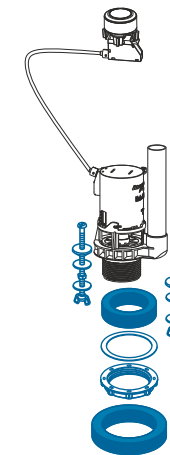
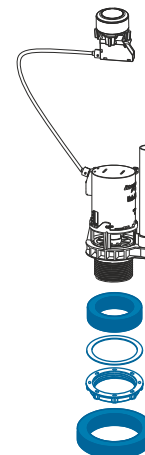

mod. UNIVERSAL

DESCARGADORES
EQUIPAMIENTO WC

ADAPTABLE AL SISTEMA
TRADICIONAL

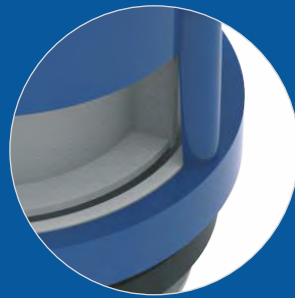

Descarga simple



Fácil y rápida
instalación

Descargador **UNIVERSAL CON BASE.**
mod. UNIVERSAL

Cod.	Emb.	€	
27012	BOLSA	6,15	45



Descargador **UNIVERSAL SIN BASE.**
mod. UNIVERSAL

Cod.	Emb.	€	
27013	BOLSA	4,60	50

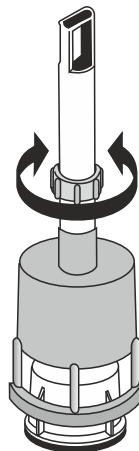



PRODUCTO
NUEVO



Descarga simple



Fácil y rápida
instalación

mod. ALCORA

DESCARGADORES EQUIPAMIENTO WC

FÁCIL Y RÁPIDA INSTALACIÓN

GOMA CIERRE CAUCHO

DESCARGA SIMPLE



ADAPTABLE AL SISTEMA
TRADICIONAL

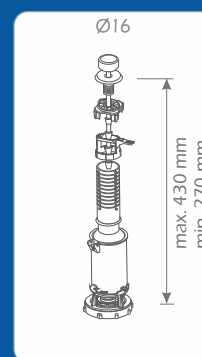

Descargador TIRADOR, con base y goma de asiento.
mod. ALCORA

Cod.	Emb.	€	
25010	BOLSA	10,70	22



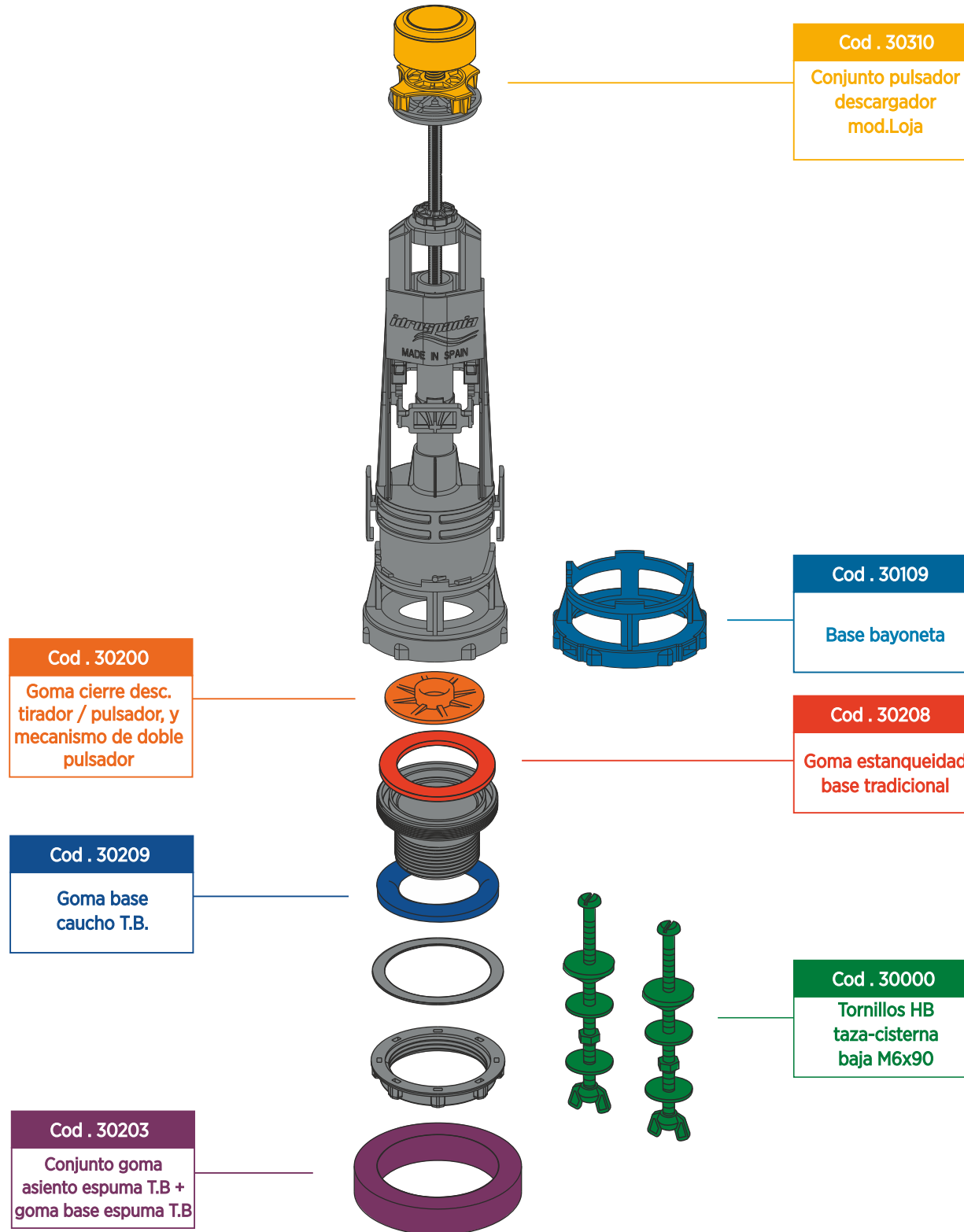

REPUESTOS DESCARGADORES
EQUIPAMIENTO WC

mod. DENIA

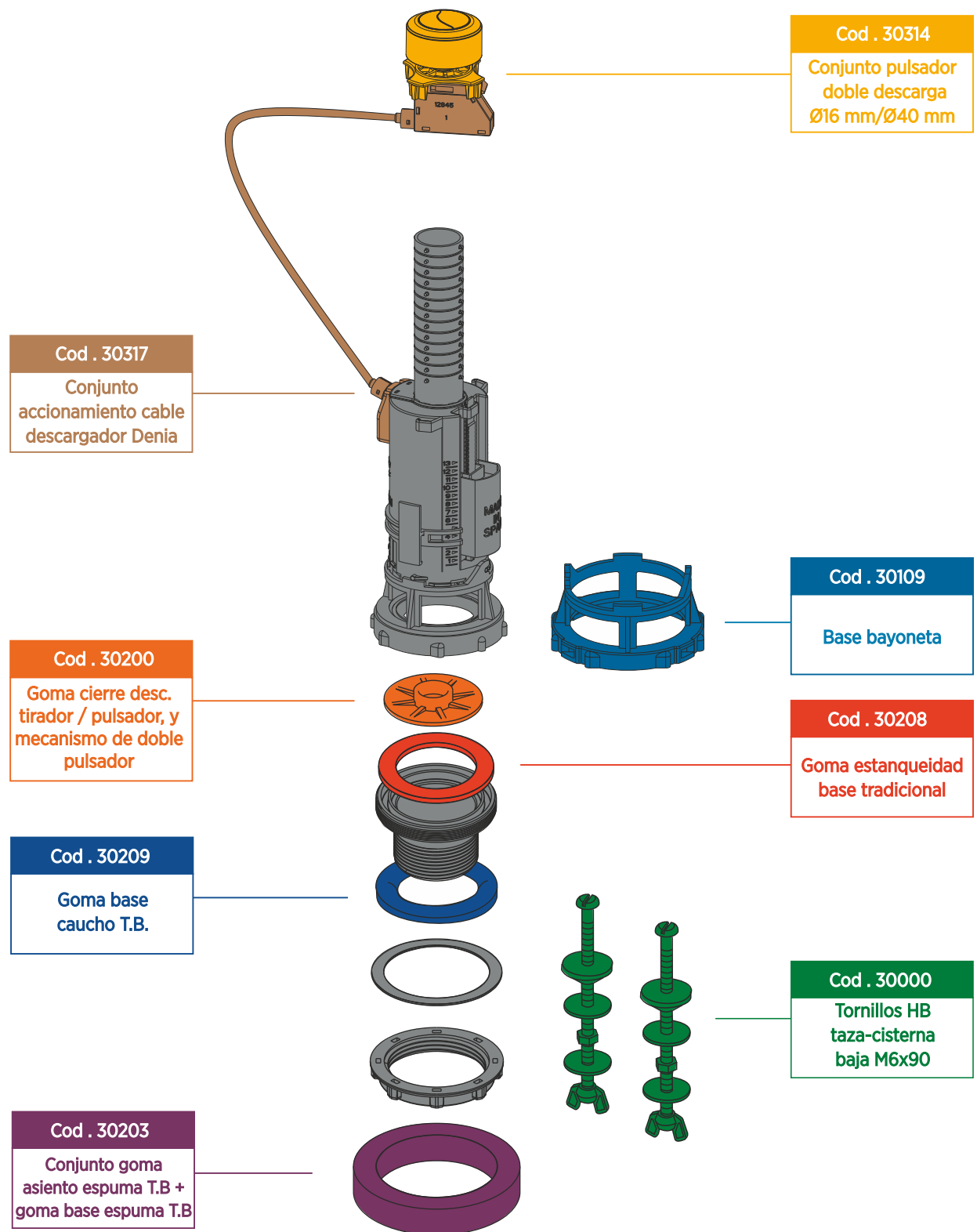

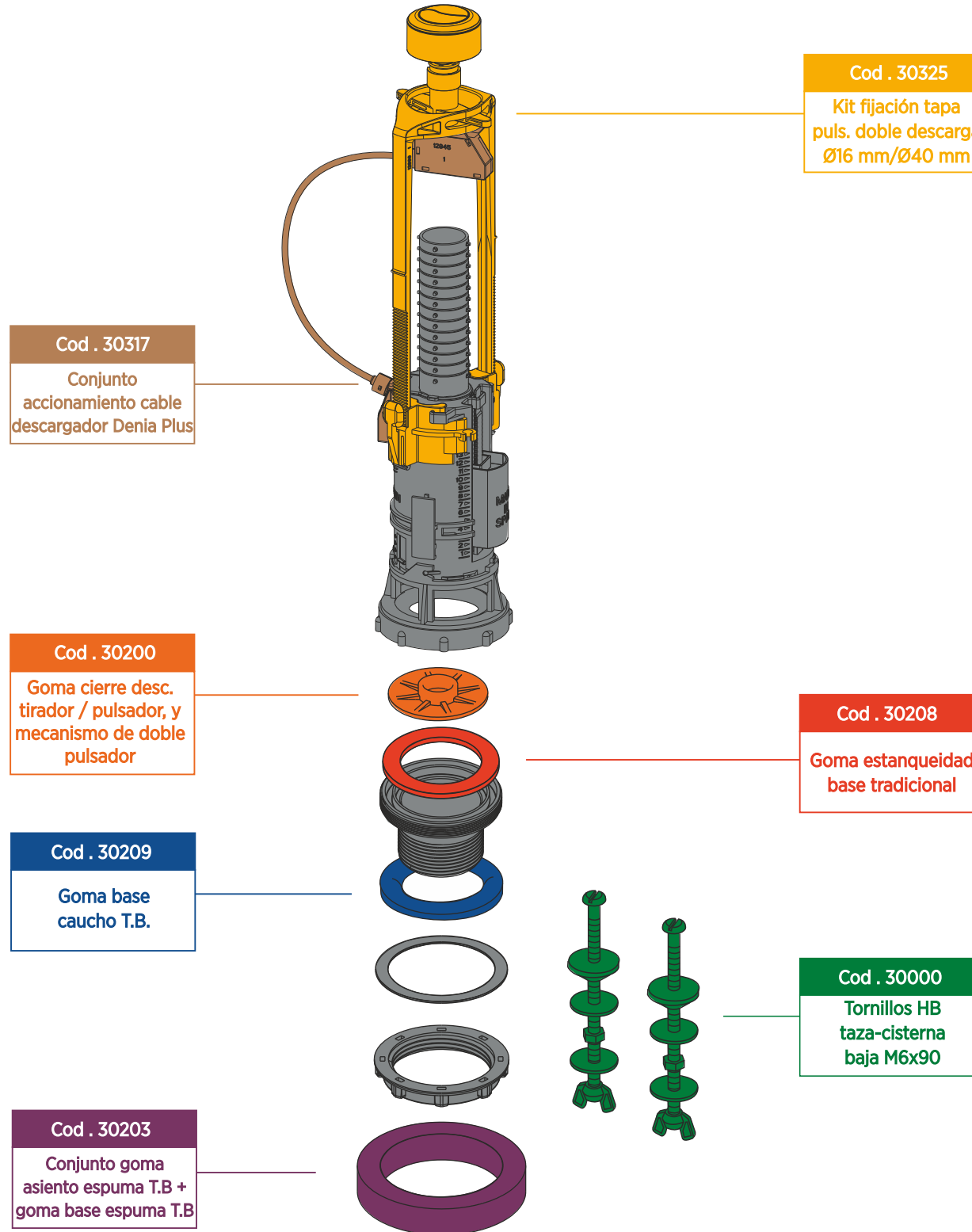

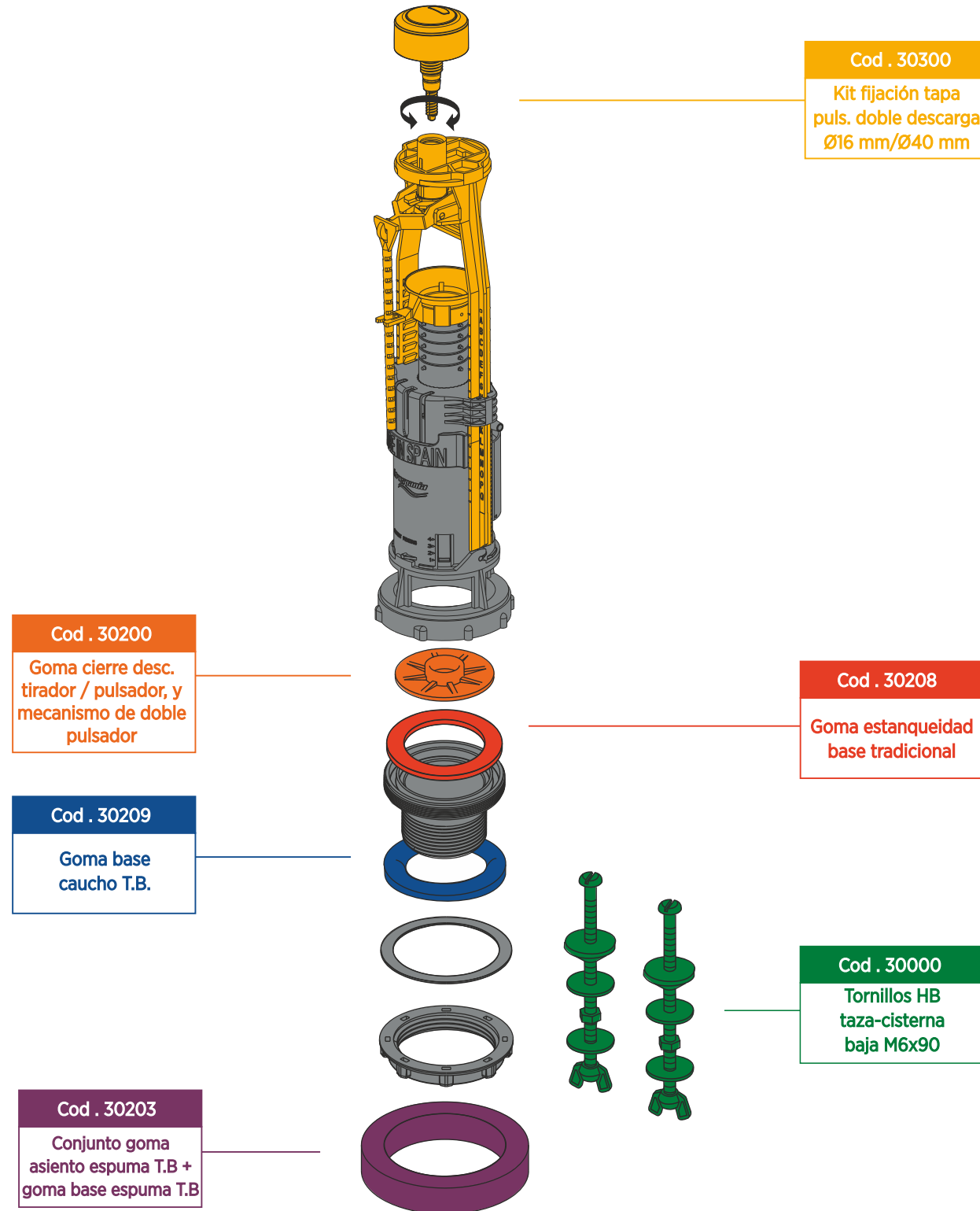

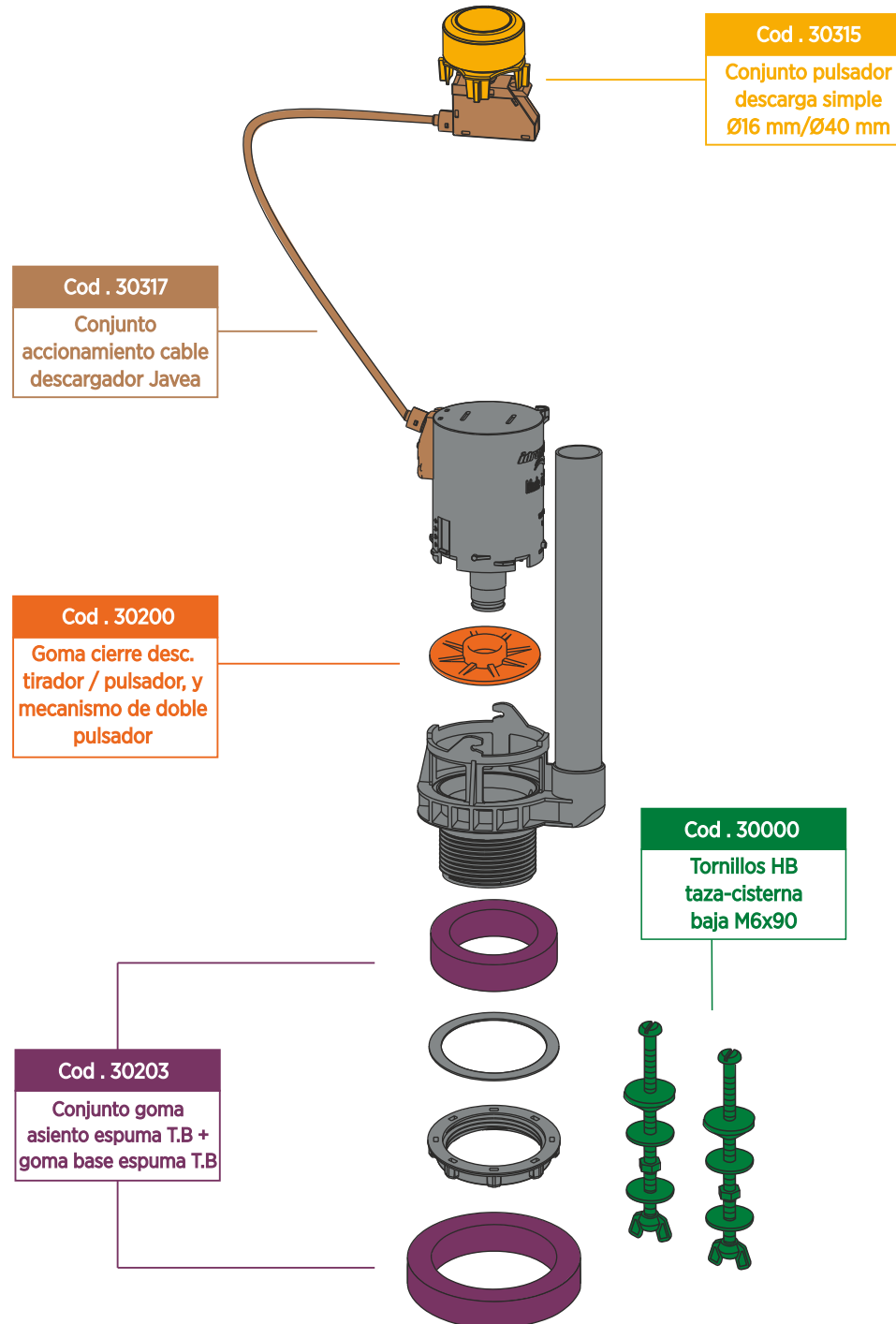

REPUESTOS DESCARGADORES
EQUIPAMIENTO WC

mod. UNIVERSAL

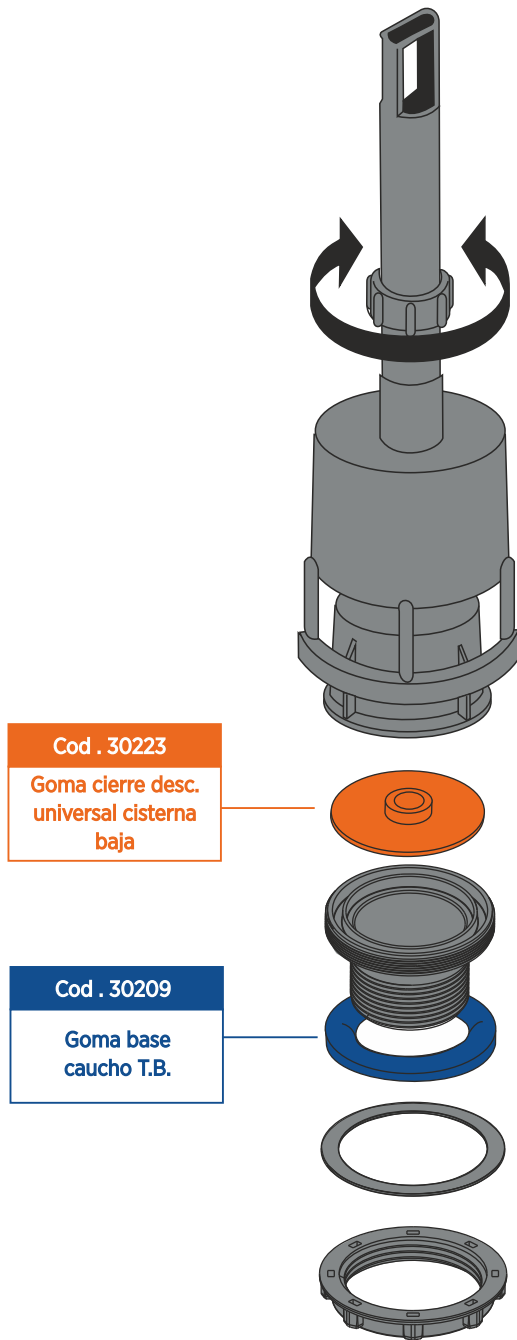

Cod . 30223
Goma cierre desc.
universal cisterna
baja

Cod . 30209
Goma base
caucho T.B.

mod. ALCORA

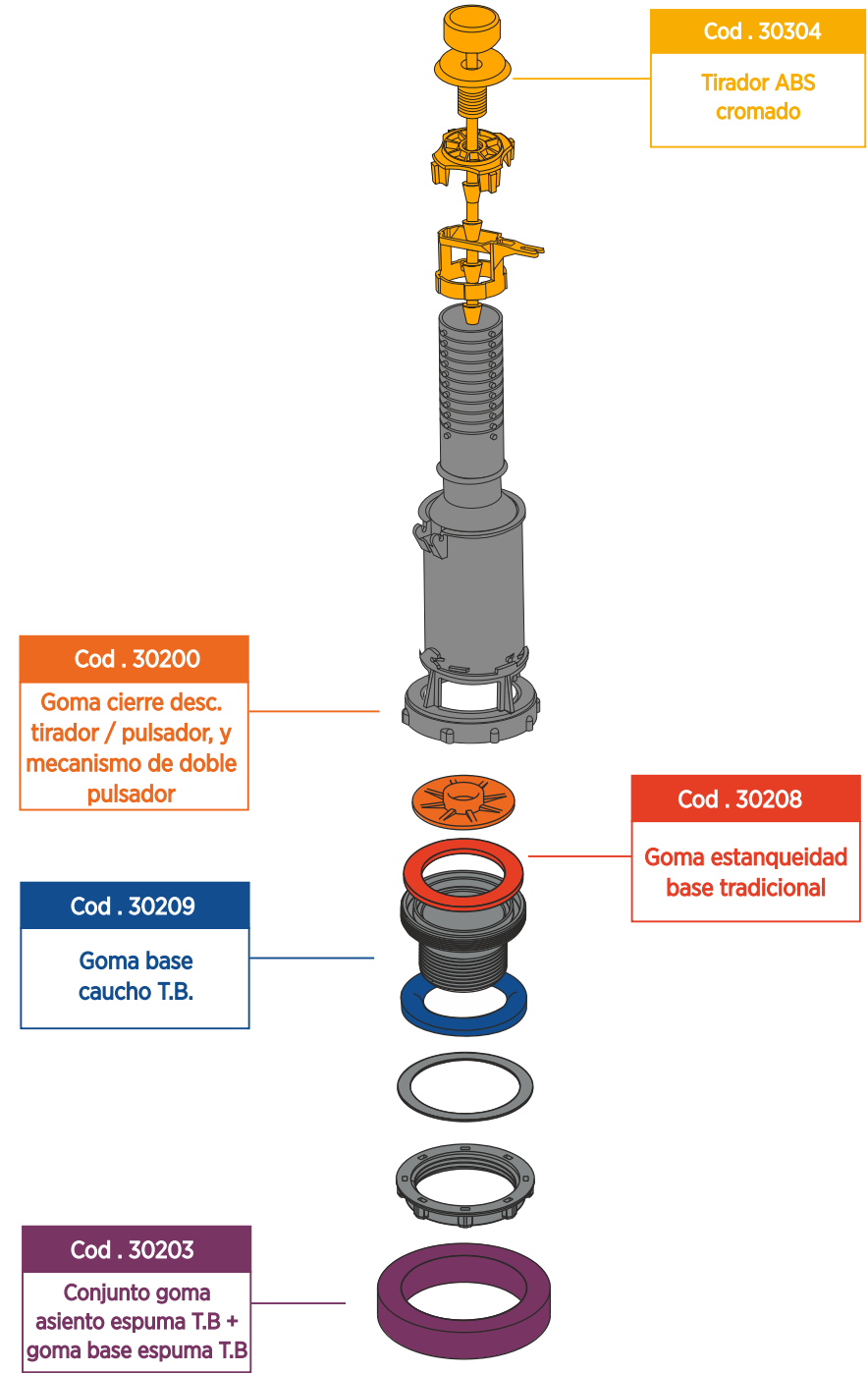

Cod . 30304
Tirador ABS
cromado

Cod . 30200
Goma cierre desc.
tirador / pulsador, y
mecanismo de doble
pulsador

Cod . 30209
Goma base
caucho T.B.

Cod . 30208
Goma estanqueidad
base tradicional

Cod . 30203
Conjunto goma
asiento espuma T.B +
goma base espuma T.B



MECANISMOS COMPLETOS

mod. DENIA

DOBLE PULSADOR

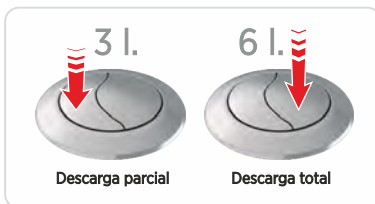

BASE UNIVERSAL COMPACTA

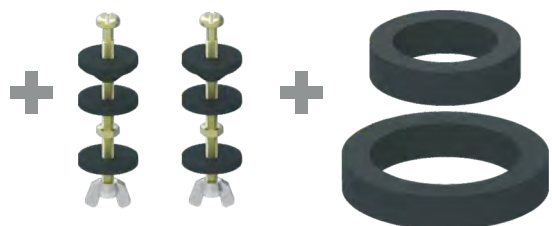
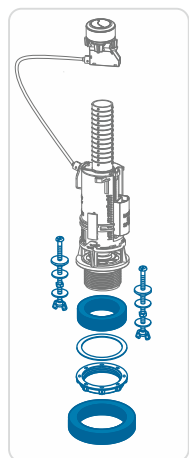

+



Mecanismo doble pulsador de CABLE, base universal modelo **Denia** + grifo alimentación LATERAL modelo **Servo**

Cod.	Emb.	€	
53100	BOLSA	32,00	15

+



Mecanismo doble pulsador de CABLE, base universal modelo **Denia** + grifo alimentación INFERIOR telescópico modelo **Servo**

Cod.	Emb.	€	
53200	BOLSA	32,30	16

+

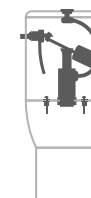

Mecanismo doble pulsador de CABLE, base universal modelo **Denia** + grifo alimentación LATERAL modelo **Lina**

Cod.	Emb.	€	
53300	BOLSA	27,25	16

+



Mecanismo doble pulsador de CABLE, base universal modelo **Denia** + grifo alimentación INFERIOR telescópico modelo **Ana**

Cod.	Emb.	€	
53400	BOLSA	29,75	15

MECANISMOS COMPLETOS
EQUIPAMIENTO WC

mod. LOJA

DESCARGA INTERRUPTIBLE

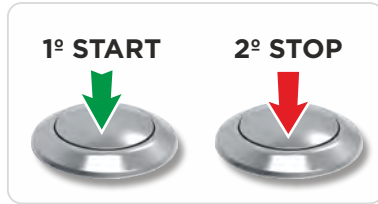

BASE UNIVERSAL COMPACTA

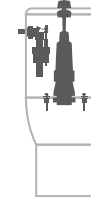
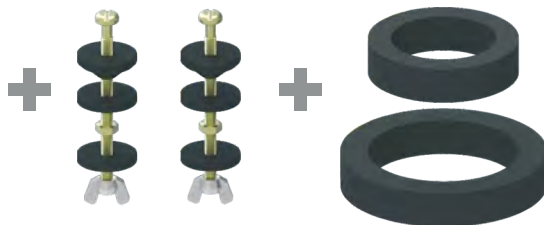
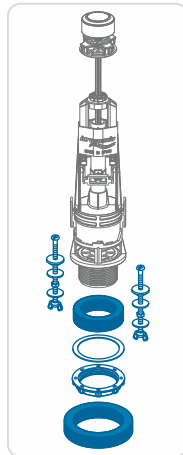

Mecanismo SIMPLE E INTERRUPTIBLE
base universal modelo **Loja** + grifo
alimentación **LATERAL** modelo Servo

Cod.	Emb.	€	
51100	BOLSA	26,50	16

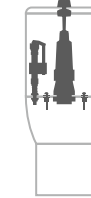

Mecanismo SIMPLE E INTERRUPTIBLE
base universal modelo **Loja** + grifo
alimentación **INFERIOR** telescópico
modelo **Servo**

Cod.	Emb.	€	
51200	BOLSA	26,75	16



Mecanismo SIMPLE E INTERRUPTIBLE
base universal modelo **Loja** + grifo
alimentación **LATERAL** modelo **Lina**

Cod.	Emb.	€	
51300	BOLSA	21,80	16

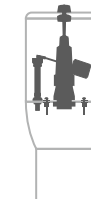

Mecanismo SIMPLE E INTERRUPTIBLE
base universal modelo **Loja** + grifo
alimentación **INFERIOR** telescópico
modelo **Ana**

Cod.	Emb.	€	
51400	BOLSA	24,25	16

MECANISMOS COMPLETOS EQUIPAMIENTO WC



MÁXIMA
ADAPTABILIDAD

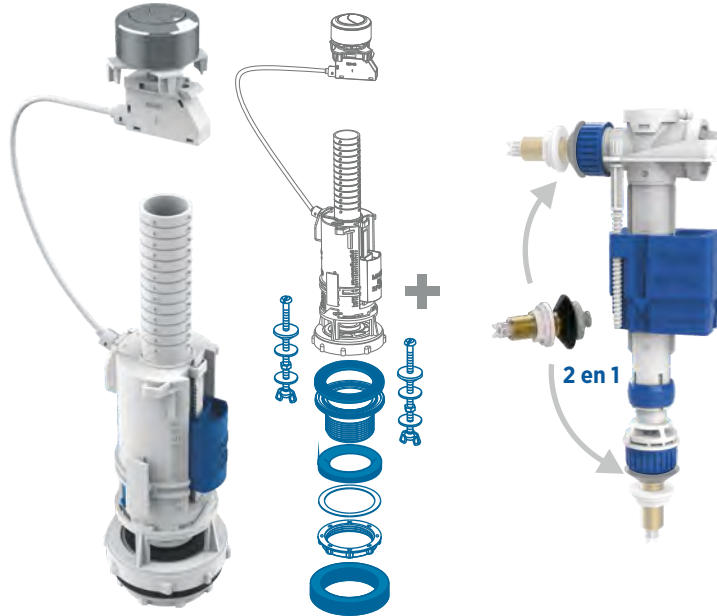

Mecanismo doble pulsador de CABLE modelo **Denia**, con tornillos taza tanque HB y GOMA de asiento + grifo de alimentación INFERIOR O LATERAL modelo **Duo Servo**

Cod.	Emb.	€	
53714	BOLSA	34,20	15
53715	CAJA	35,90	10

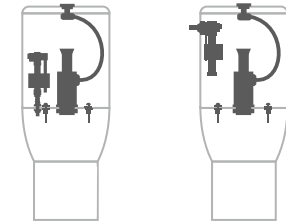

MÁXIMA
ADAPTABILIDAD

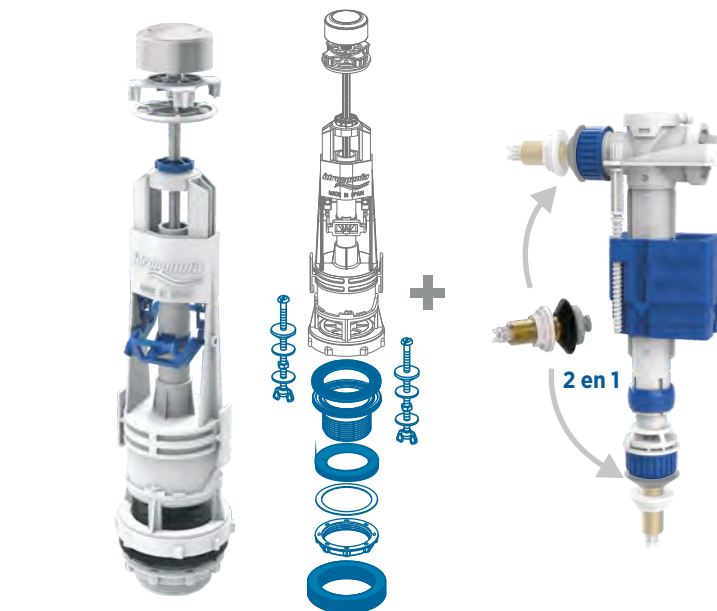

Mecanismo de pulsador SIMPLE E INTERRUPTIBLE modelo **Loja**, con tornillos taza tanque HB y GOMA de asiento + grifo de alimentación INFERIOR O LATERAL modelo **Duo Servo**

Cod.	Emb.	€	
51714	BOLSA	30,90	15
51715	CAJA	32,20	10

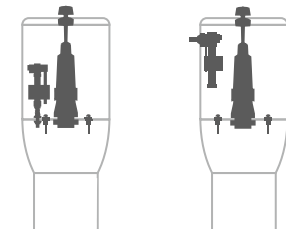



GRIFOS DE ALIMENTACIÓN

mod. DUO SERVO ORIENTABLE

GRIFOS DE ALIMENTACIÓN EQUIPAMIENTO WC



- Cabezal orientable 180°
- Ahorro de espacio
 - Evita el contacto con el descargador

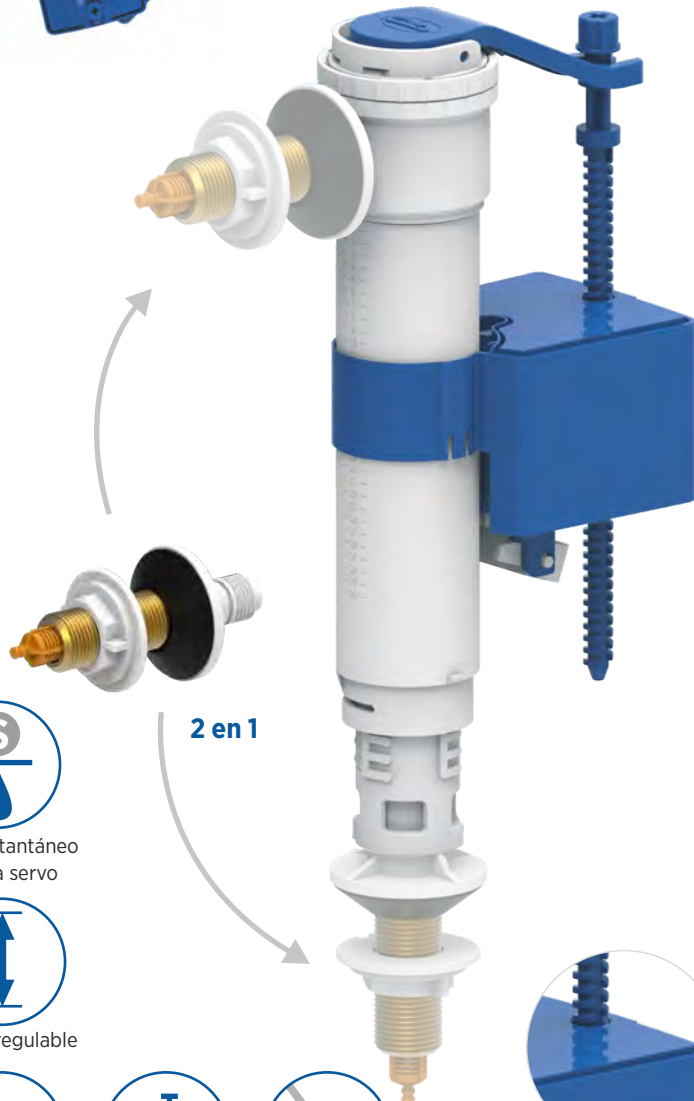

Características Técnicas:

- ▶ Presiones de trabajo desde 0,2 a 16 bar.
- ▶ Rápida instalación.
- ▶ Compatible con todas las cisternas cerámicas.
- ▶ Fabricado con polímeros plásticos de alta calidad y anticalcáreos.
- ▶ Ahorro de agua mediante retardo en la apertura de llenado.
- ▶ Casquillo latón 3/8"
- ▶ Sistema antirretorno

Grifo flotador compacto alimentación lateral o inferior modelo **Duo Servo orientable**

Cod.	Emb.	€	
21600	BOLSA	14,95	45
21601	CAJA	15,95	27
21601.1	BOX CAJA	15,95	100

Asegúrese de que el casquillo está enroscado completamente

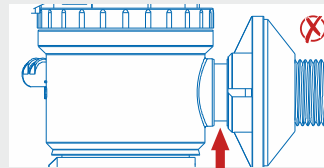

INCORRECTO: Hay un hueco

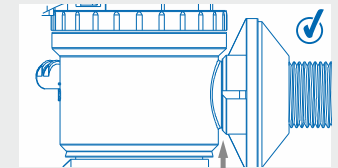

CORRECTO: No hay un hueco



Cierre instantáneo sistema servo



Altura regulable



Filtro de agua incorporado



Fácil y rápida instalación



Llenado rápido y silencioso

2 en 1

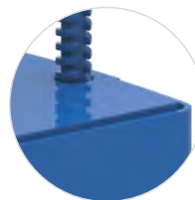

Vaso con boya interna

2 EN 1: Con diferentes montajes se configura el grifo para alimentación inferior o lateral
BOYA REGULABLE EN ALTURA
TELESCÓPICO AJUSTABLE EN ALTURA

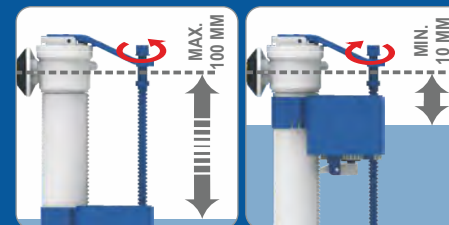

LATERAL

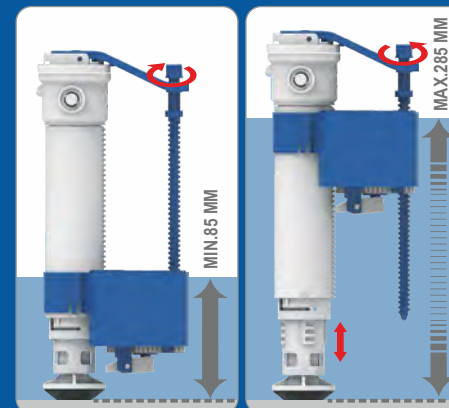
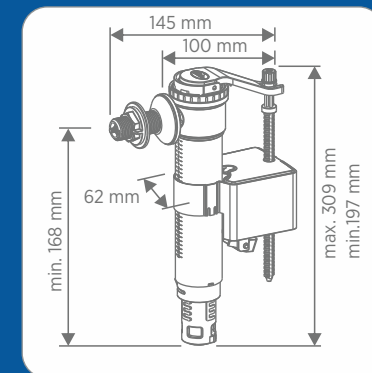

INFERIOR

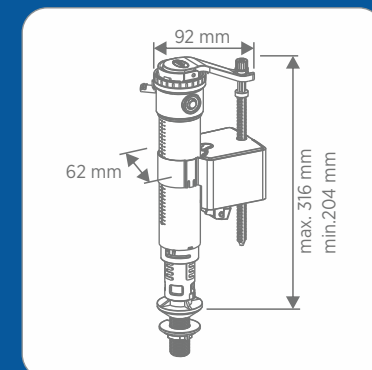

GRIFOS DE ALIMENTACIÓN EQUIPAMIENTO WC

mod. DUO SERVO

Diseño de pasador y sello que proporciona un óptimo comportamiento



Grifo flotador compacto alimentación lateral o inferior modelo **Duo Servo**

	Cod.	Emb.	€	
CASQUILLO LATÓN 3/8"	21100	BOLSA	13,85	45
CASQUILLO LATÓN 3/8"	21101	CAJA	14,85	27
CASQUILLO LATÓN 3/8"	21101.1	BOX CAJA	14,85	100
CASQUILLO LATÓN 1/2"	21103	BOLSA	14,35	45

PRODUCTO NUEVO

Características Técnicas:

- ▶ Presiones de trabajo desde 0,2 a 16 bar. Resiste picos de presión hasta 21 bar.
- ▶ Rápida instalación.
- ▶ Compatible con todas las cisternas cerámicas.
- ▶ Fabricado con polímeros plásticos de alta calidad y anticalcáreos.
- ▶ Casquillo latón 3/8" · 1/2"
- ▶ Sistema antirretorno

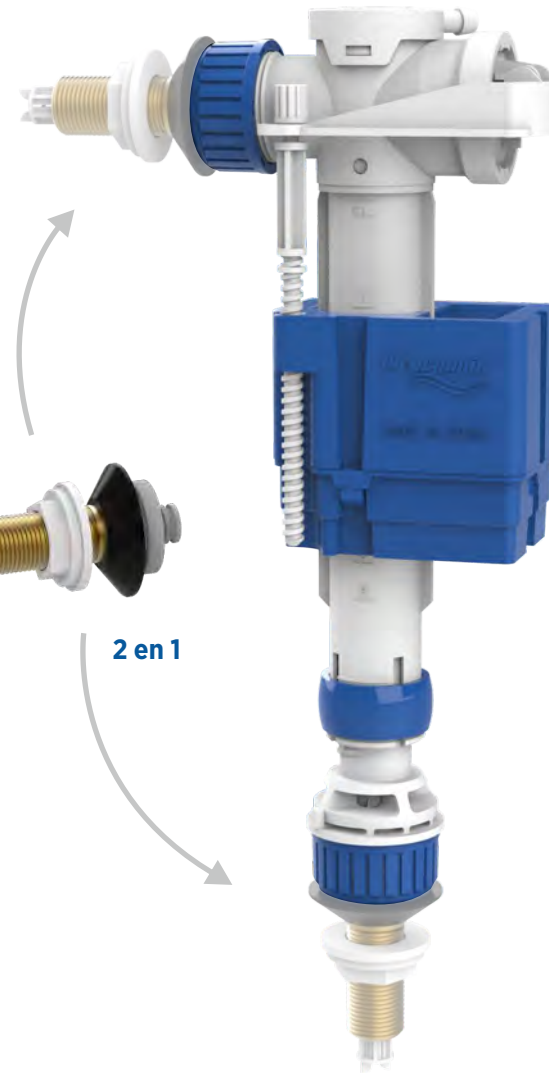

Cierre instantáneo sistema servo

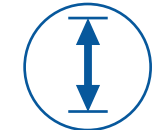

Altura regulable



Filtro de agua incorporado



Fácil y rápida instalación



Llenado rápido y silencioso

2 en 1

LATERAL

2 EN 1: Con diferentes montajes se configura el grifo para alimentación inferior o lateral

BOYA REGULABLE EN ALTURA

TELESCÓPICO AJUSTABLE EN ALTURA

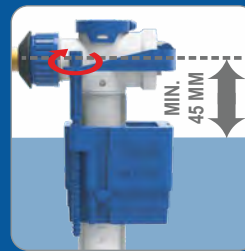
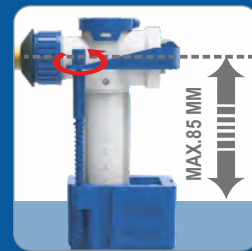
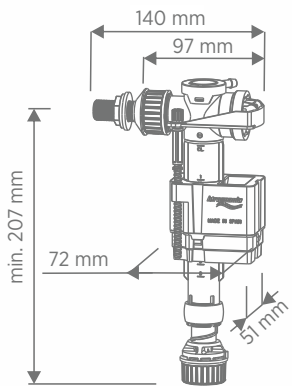

INFERIOR

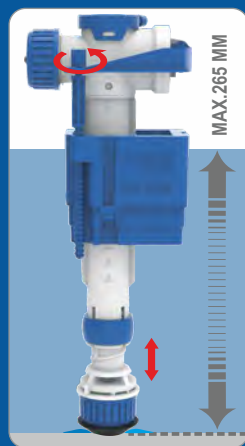
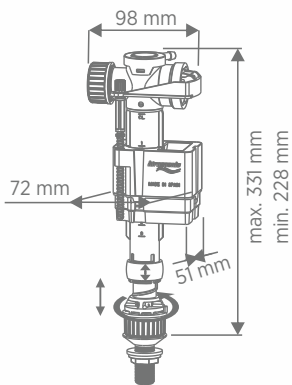

mod. DUO COMPACT GRIFOS DE ALIMENTACIÓN EQUIPAMIENTO WC

Características Técnicas:

- ▶ Presiones de trabajo desde 0,5 a 10 bar. Resiste picos de presión hasta 12 bar.
- ▶ Rápida instalación.
- ▶ Compatible con todas las cisternas cerámicas.
- ▶ Fabricado con polímeros plásticos de alta calidad y anticálceos.
- ▶ Casquillo latón 3/8" · 1/2"
- ▶ Sistema antirretorno

Grifo flotador compacto alimentación lateral o inferior cierre por pistón modelo **Duo Compact**

Cod.	Emb.	€		
21300	BOLSA	12,95	35	CASQUILLO LATÓN 3/8"
21301	CAJA	13,95	21	CASQUILLO LATÓN 3/8"
21301.1	BOX CAJA	13,95	84	CASQUILLO LATÓN 3/8"
21303	BOLSA	13,45	35	CASQUILLO LATÓN 1/2"

PRODUCTO NUEVO

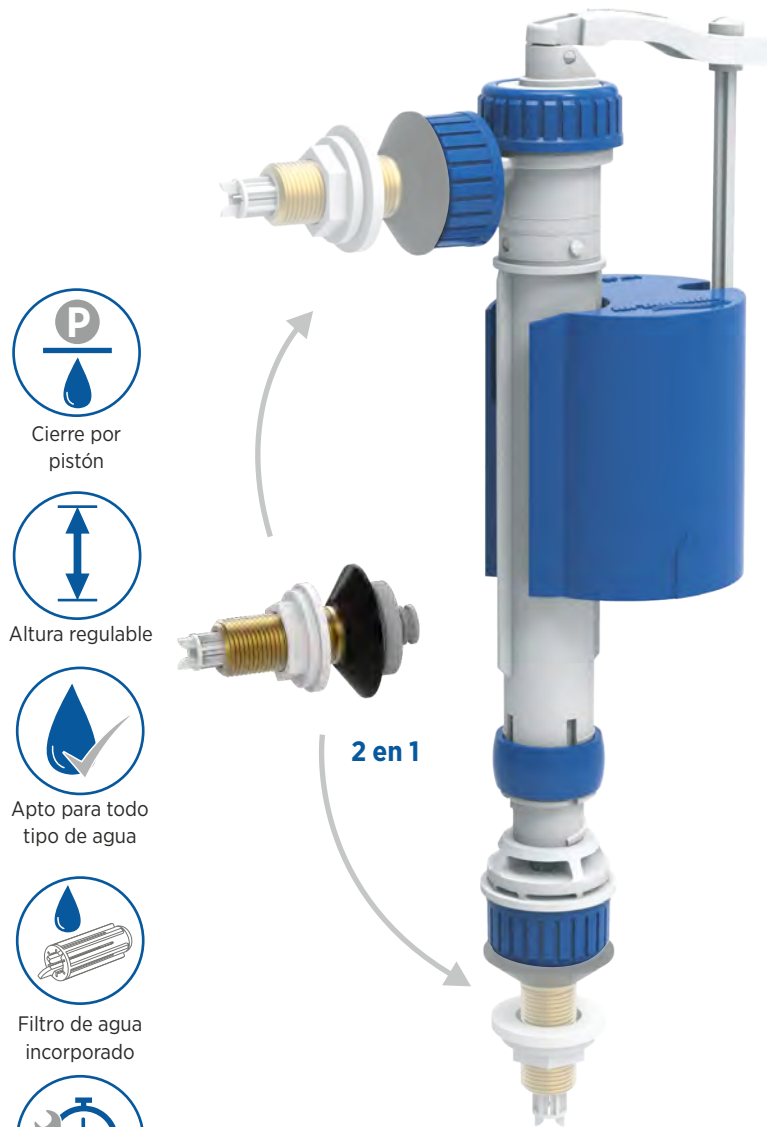

- Cierre por pistón
- Altura regulable
- Apto para todo tipo de agua
- Filtro de agua incorporado
- Fácil y rápida instalación

2 EN 1: Con diferentes montajes se configura el grifo para alimentación inferior o lateral

BOYA REGULABLE EN ALTURA
TELESCÓPICO AJUSTABLE EN ALTURA

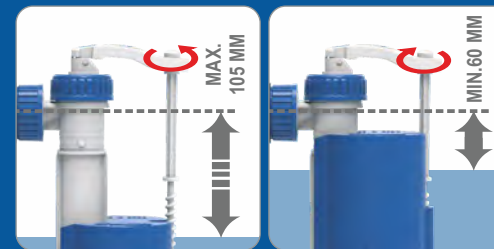

LATERAL

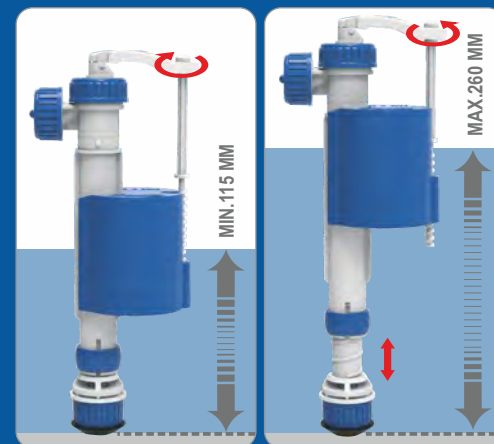
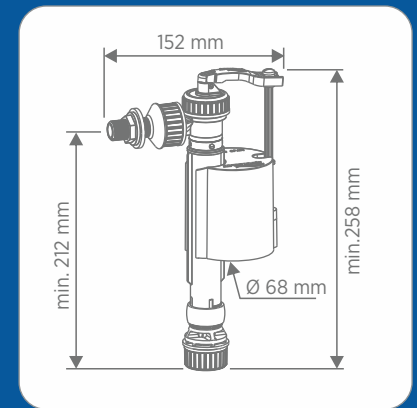

INFERIOR

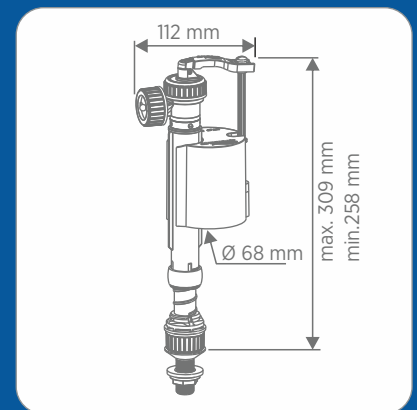

GRIFOS DE ALIMENTACIÓN EQUIPAMIENTO WC

mod. SERVO



Grifo flotador compacto
alimentación lateral modelo **Servo**

Cod.	Emb.	€	
20100	BOLSA	10,70	45
20101	CAJA	11,70	27

Características Técnicas:

- ▶ Presiones de trabajo desde 0,5 a 12 bar. Resiste picos de presión hasta 16 bar.
- ▶ Rápida instalación.
- ▶ Compatible con todas las cisternas cerámicas.
- ▶ Fabricado con polímeros plásticos de alta calidad y anticalcáreos.
- ▶ Casquillo latón 3/8"
- ▶ Sistema antirretorno



Cierre instantáneo sistema servo



Filtro de agua incorporado



Fácil y rápida instalación



Lenado rápido y silencioso

BOYA REGULABLE EN ALTURA

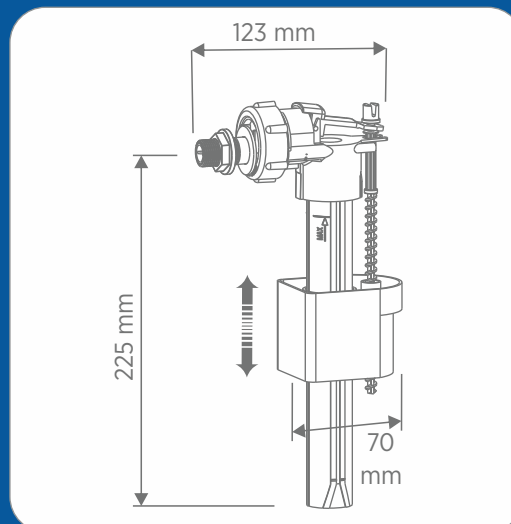
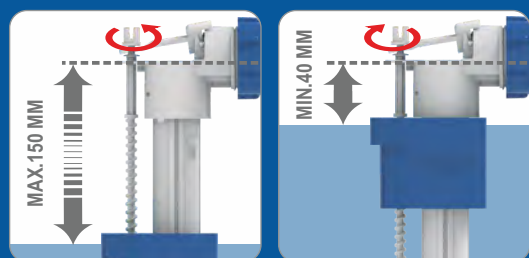



Características Técnicas:

- ▶ Presiones de trabajo desde 0,5 a 10 bar. Resiste picos de presión hasta 12 bar.
- ▶ Rápida instalación.
- ▶ Compatible con todas las cisternas cerámicas.
- ▶ Fabricado con polímeros plásticos de alta calidad y anticalcáreos.
- ▶ Casquillo latón 3/8" · 1/2"
- ▶ Sistema antirretorno

Grifo flotador compacto alimentación lateral cierre por pistón modelo Compact

Cod.	Emb.	€		
20800	BOLSA	10,40	35	CASQUILLO LATÓN 3/8"
20801	CAJA	11,40	20	CASQUILLO LATÓN 3/8"
20803	BOLSA	10,90	35	CASQUILLO LATÓN 1/2"

PRODUCTO NUEVO



Cierre por pistón



Apto para todo tipo de agua



Filtro de agua incorporado



Fácil y rápida instalación

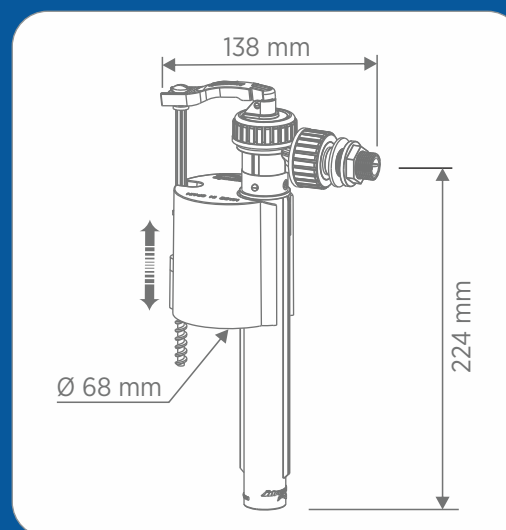

BOYA REGULABLE EN ALTURA

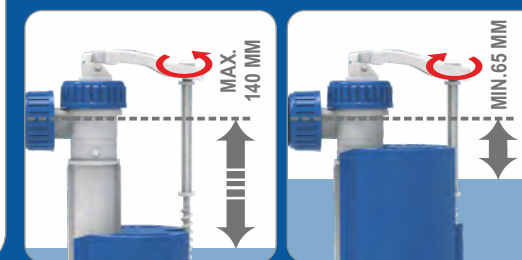

GRIFOS DE ALIMENTACIÓN EQUIPAMIENTO WC

mod. SERVO SUPER COMPACT

Grifo telescópico Servo
alimentación inferior modelo
Servo Super Compact

Cod.	Emb.	€	
21400	BOLSA	13,80	50
21401	CAJA	14,80	24

Características Técnicas:

- ▶ Presiones de trabajo desde 0,2 a 16 bar.
- ▶ Rápida instalación.
- ▶ Compatible con todas las cisternas cerámicas.
- ▶ Fabricado con polímeros plásticos de alta calidad y anticalcáreos.
- ▶ Casquillo latón 3/8"
- ▶ Sistema antirretorno

Seguro de regulación en la parte superior

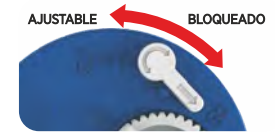

Filtro incorporado en el cabezal que facilita su mantenimiento



Cierre instantáneo sistema servo

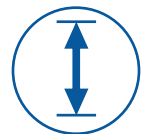

Altura regulable



Filtro de agua incorporado



Fácil y rápida instalación



Llenado rápido y silencioso



TELESCÓPICO AJUSTABLE EN ALTURA

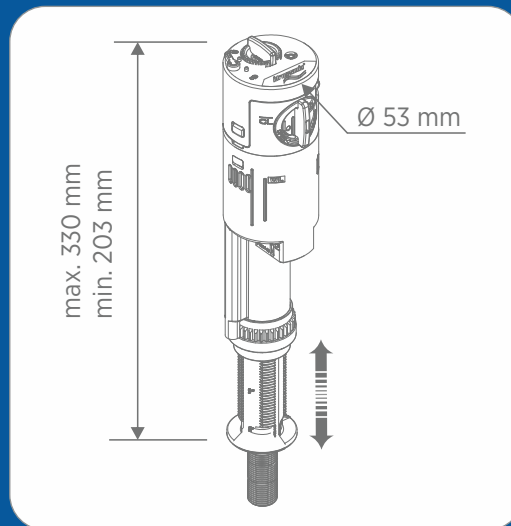
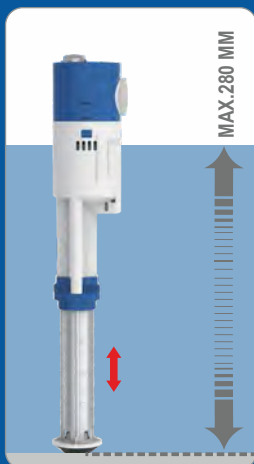

mod. SERVO

GRIFOS DE ALIMENTACIÓN EQUIPAMIENTO WC

Grifo flotador compacto alimentación inferior telescópico modelo **Servo**

Características Técnicas:

- ▶ Presiones de trabajo desde 0,5 a 12 bar. Resiste picos de presión hasta 16 bar.
- ▶ Rápida instalación.
- ▶ Compatible con todas las cisternas cerámicas.
- ▶ Fabricado con polímeros plásticos de alta calidad y anticálceos.
- ▶ Casquillo latón 3/8" · 1/2"
- ▶ Sistema antirretorno

PRODUCTO NUEVO

Cod.	Emb.	€		
20200	BOLSA	10,95	50	CASQUILLO LATÓN 3/8"
20201	CAJA	12,05	27	CASQUILLO LATÓN 3/8"
20203	BOLSA	11,45	50	CASQUILLO LATÓN 1/2"



Cierre instantáneo sistema servo

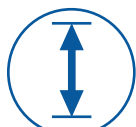

Altura regulable



Filtro de agua incorporado



Fácil y rápida instalación



Llenado rápido y silencioso

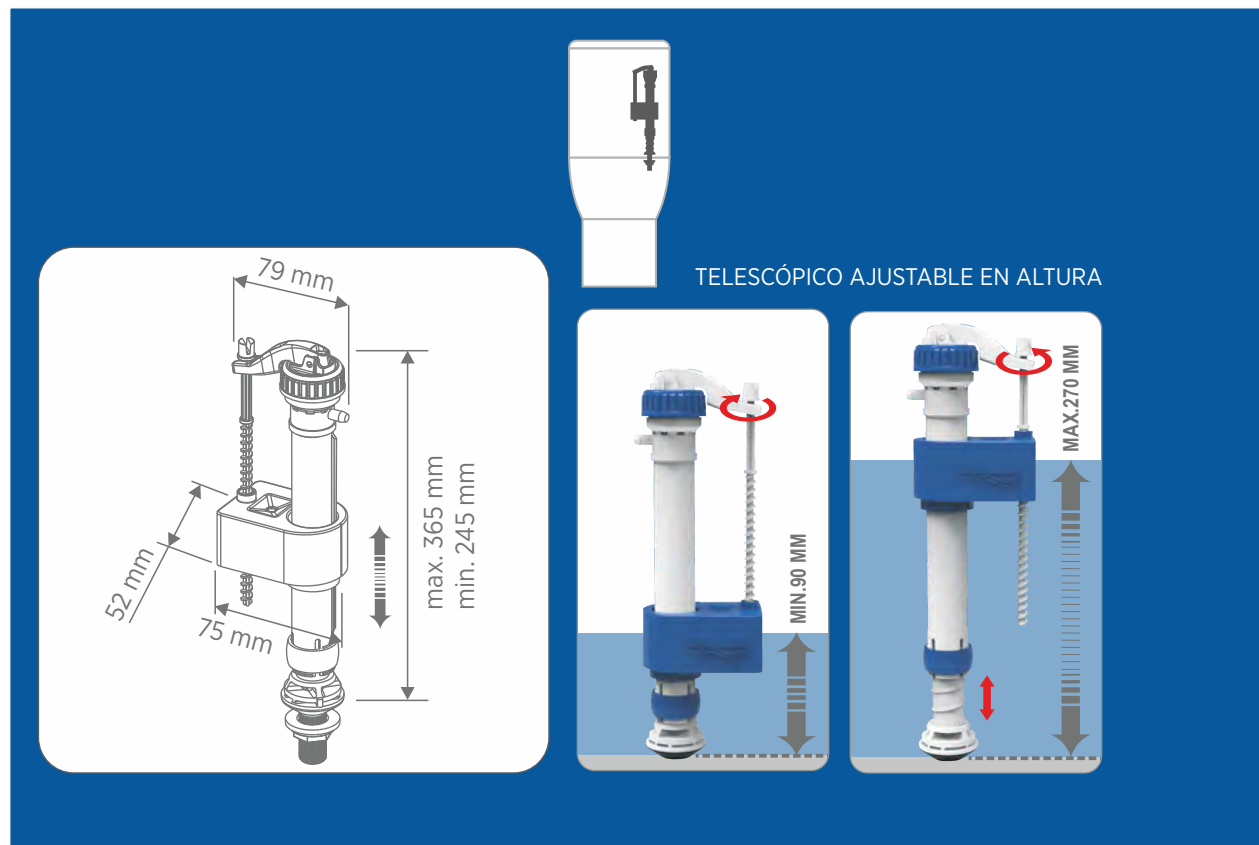

GRIFOS DE ALIMENTACIÓN EQUIPAMIENTO WC

Grifo flotador telescópico compacto alimentación inferior cierre por pistón modelo **Compact**

	Cod.	Emb.	€	
CASQUILLO LATÓN 3/8"	20600	BOLSA	10,40	40
CASQUILLO LATÓN 3/8"	20601	CAJA	11,40	24
CASQUILLO LATÓN 1/2"	20603	BOLSA	10,90	24

PRODUCTO NUEVO

mod. COMPACT

Características Técnicas:

- ▶ Presiones de trabajo desde 0,5 a 10 bar. Resiste picos de presión hasta 12 bar.
- ▶ Rápida instalación.
- ▶ Compatible con todas las cisternas cerámicas.
- ▶ Fabricado con polímeros plásticos de alta calidad y anticalcáreos.
- ▶ Casquillo latón 3/8" · 1/2"
- ▶ Sistema antirretorno



Cierre por pistón

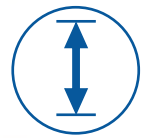

Altura regulable



Apto para todo tipo de agua



Filtro de agua incorporado



Fácil y rápida instalación

TELESCÓPICO AJUSTABLE EN ALTURA

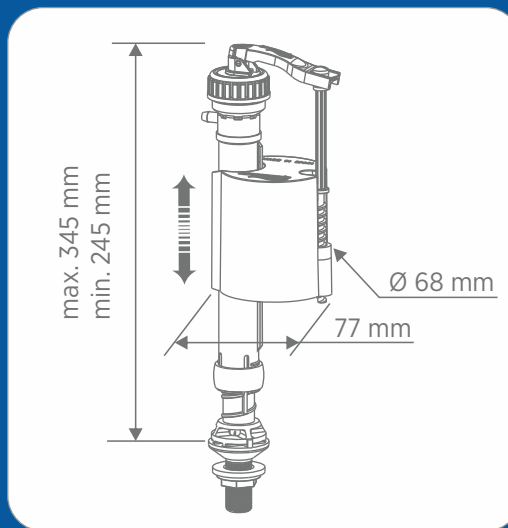
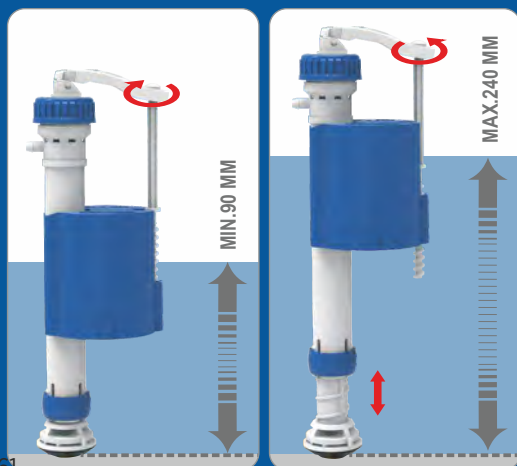



Apto para todo tipo de agua



Fácil y rápida instalación



Apto para todo tipo de agua



Fácil y rápida instalación

Cod.		€	
------	--	---	--

20300

Grifo alimentación lateral con BOYA SOPLADO.
Modelo **Lina**
-Casquillo latón 3/8"
-Varilla latón
-Tornillo regulación latón

6,00

65

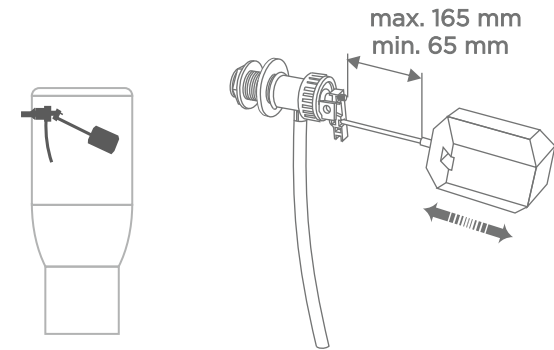

Cod.		€	
------	--	---	--

20301

Grifo alimentación lateral con BOYA ESPUMA.
Modelo **Lina**
-Casquillo latón 3/8"
-Varilla latón
-Tornillo regulación latón

6,25

60

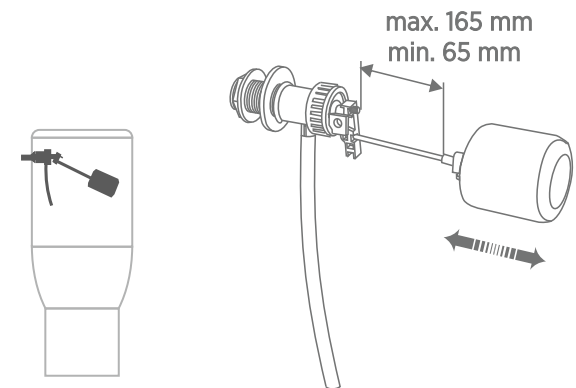

GRIFOS DE ALIMENTACIÓN EQUIPAMIENTO WC

mod. Ana

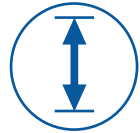

Altura regulable



Apto para todo tipo de agua



Fácil y rápida instalación



Cod.	€	📦
------	---	---

20400

Grifo alimentación inferior telescópico con BOYA SOPLADO.

Modelo **Ana**

-Casquillo latón 3/8"

-Varilla latón

-Tornillo regulación latón

8,40

55

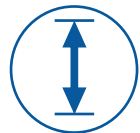
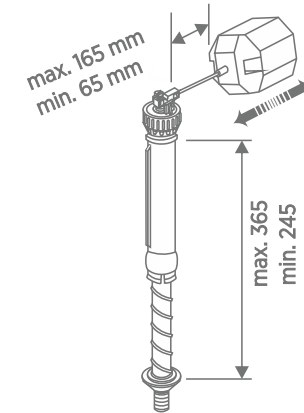
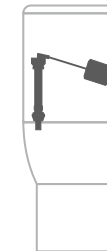

Altura regulable



Apto para todo tipo de agua



Fácil y rápida instalación



Cod.	€	📦
------	---	---

20401

Grifo alimentación inferior telescópico con BOYA ESPUMA.

Modelo **Ana**

-Casquillo latón 3/8"

-Varilla latón

-Tornillo regulación latón

8,70

45

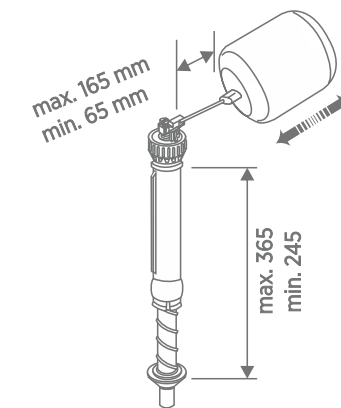



CONJUNTOS HIGIÉNICOS DUCHA-BIDET



Cod.	€	
70078 Conjunto higiénico MODELO OROPESA	129,25	-

Conjunto higiénico MODELO OROPESA, Monomando empotrado mezclador de agua fría-caliente, para sustituir el bidet.

Compuesto por:

- Monomando con cuerpo empotrado de latón y soporte con toma.
- Ducha-bidet de latón cromado.
- Embellecedor de latón cromado.
- Flexible de doble grapado ACERO INOX de 1,20 m con tuercas ANTI-TWIST de latón cromadas

ACABADO CROMADO

AGUA FRÍA Y CALIENTE  

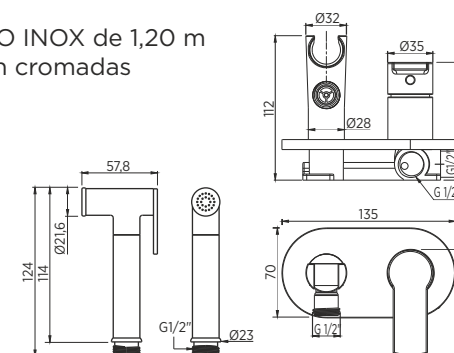

Cod.	€	
70077 Conjunto higiénico MODELO BENICASSIM	83,75	-

Conjunto higiénico MODELO BENICASSIM, Monomando empotrado mezclador de agua fría-caliente, para sustituir el bidet.

Compuesto por:

- Monomando con cuerpo empotrado de latón.
- Soporte latón ajustable en el monomando.
- Ducha-bidet de latón cromado.
- Embellecedor de latón cromado.
- Flexible de doble grapado ACERO INOX de 1,20 m con tuercas ANTI-TWIST de latón cromadas

ACABADO CROMADO

AGUA FRÍA Y CALIENTE  

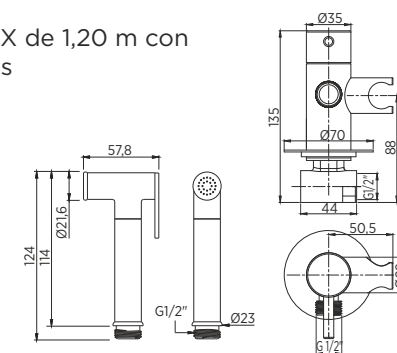

DUCHA-BIDET



Cod.	€	
70078.NE	Conjunto higiénico MODELO OROPESA	158,95 -

Conjunto higiénico MODELO OROPESA, Monomando empotrado mezclador de agua fría-caliente, para sustituir el bidet

Compuesto por:

- Monomando con cuerpo empotrado de latón y soporte con toma.
- Ducha-bidet de latón.
- Embellecedor de latón.
- Flexible de doble grapado PVC de 1,20m con tuercas ANTI-TWIST de latón.



CIERRE SEGURIDAD

ACABADO NEGRO MATE

AGUA FRÍA Y CALIENTE  

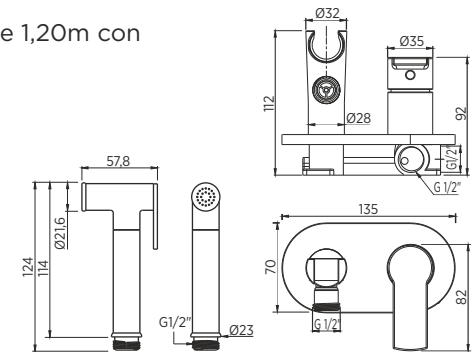

Cod.	€	
70077.NE	Conjunto higiénico MODELO BENICASSIM	109,00 -

Conjunto higiénico MODELO BENICASSIM, Monomando empotrado mezclador de agua fría-caliente, para sustituir el bidet

Compuesto por:

- Monomando con cuerpo empotrado de latón.
- Soporte latón ajustable en el monomando.
- Ducha-bidet de latón.
- Embellecedor de latón.
- Flexible de doble grapado PVC de 1,20m con tuercas ANTI-TWIST de latón.

ACABADO NEGRO MATE

AGUA FRÍA Y CALIENTE  

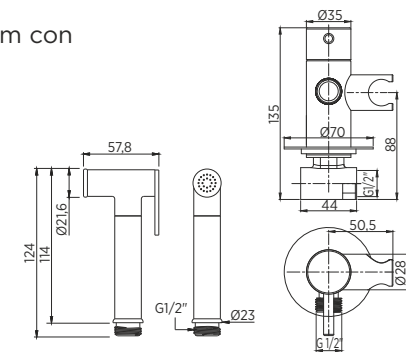



PRODUCTO
NUEVO

Cod.		€	
70078.ECO	Conjunto higiénico MODELO OROPESA ECO	83,90	-

Conjunto higiénico MODELO OROPESA ECO,
Monomando empotrado mezclador de agua fría-caliente,
para sustituir el bidet.

Compuesto por:

- Monomando con cuerpo empotrado de latón y soporte con toma.
- Ducha-bidet de latón cromado.
- Embellecedor de latón cromado.
- Flexible de doble grapado ACERO INOX de 1,20 m con tuercas ANTI-TWIST de latón cromadas

ACABADO CROMADO

AGUA FRÍA Y CALIENTE

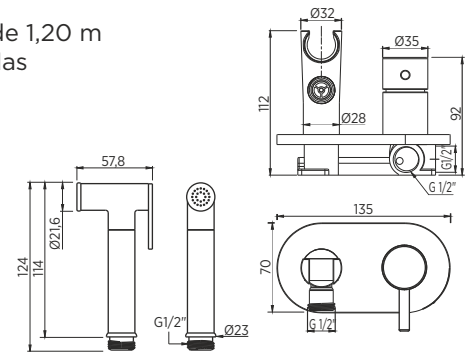

PRODUCTO
NUEVO

Cod.		€	
70071.NE	Conjunto higiénico de un agua ducha-bidet con flexible PVC negro mate	79,75	-

Compuesto por:

- Ducha-bidet LATÓN negro
- Soporte LATÓN negro
- Llave de escuadra LATÓN negro doble salida
- Embellecedor LATÓN Ø50
- Flexible 1,2 m con tuerca de latón negro mate

*No incluye latiguillo a cisterna de inodoro



Permite cerrar de una forma independiente el agua a la ducha y al tanque del inodoro.

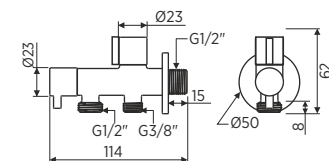
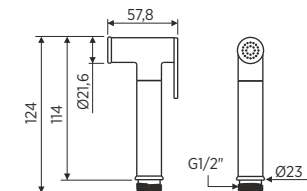

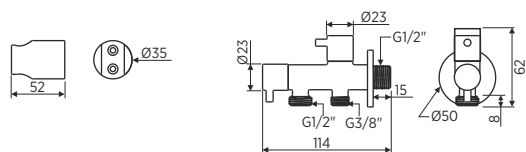
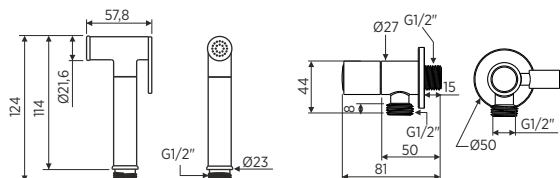

Cod.		€	
70074	Conjunto higiénico de un agua ducha-bidet con flexible doble grapado ACERO INOX. ANTI-TWIST	38,10	-

Compuesto por:

- Ducha-bidet LATÓN cromado
- Soporte ABS cromado
- Flexible 1,2 m con tuerca de latón cromado

Cod.		€	
70076	Conjunto higiénico de un agua ducha-bidet con flexible doble grapado ACERO INOX. ANTI-TWIST	39,80	-

Compuesto por:

- Ducha-bidet LATÓN cromado
- Llave de escuadra LATÓN cromado con soporte
- Embellecedor ACERO INOX Ø50
- Flexible 1,2 m con tuerca de latón cromado



Llave con soporte incorporado y sistema de cierre automático del suministro de agua al colgar la ducha en el soporte.

Cod.		€	
70072	Conjunto higiénico de un agua ducha-bidet con flexible doble grapado ACERO INOX. ANTI-TWIST	41,95	-

Compuesto por:

- Ducha-bidet LATÓN cromado
- Soporte ABS cromado
- Llave de escuadra LATÓN cromado doble salida
- Embellecedor ACERO INOX Ø50
- Flexible 1,2 m con tuerca de latón cromado

*No incluye latiguillo a cisterna de inodoro



Permite cerrar de una forma independiente el agua a la ducha y al tanque del inodoro.



Cod.		€	
70084	Conjunto higiénico de un agua ducha-bidet con flexible doble grapado ACERO INOX. ANTI-TWIST	20,90	-

Compuesto por:

- Ducha-bidet ABS cromado cuerpo cilíndrico
- Soporte ABS cromado
- Flexible 1,2 m con tuerca de latón cromado



Cod.		€	
70086	Conjunto higiénico de un agua ducha-bidet con flexible doble grapado ACERO INOX. ANTI-TWIST	35,60	-

Compuesto por:

- Ducha-bidet ABS cromado cuerpo cilíndrico
- Llave de escuadra LATÓN cromado con soporte
- Embellecedor ACERO INOX Ø50
- Flexible 1,2 m con tuerca de latón cromado

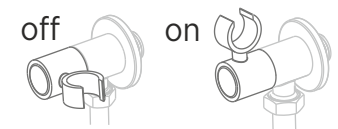

Llave con soporte incorporado y sistema de cierre automático del suministro de agua al colgar la ducha en el soporte.



CIERRE AUTOMÁTICO DE AGUA



FLUJO CONTÍNUO DE AGUA

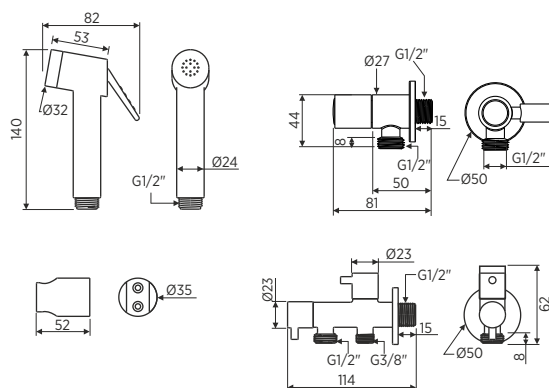

Cod.		€	
70082	Conjunto higiénico de un agua ducha-bidet con flexible doble grapado ACERO INOX. ANTI-TWIST	37,50	-

Compuesto por:

- Ducha-bidet ABS cromado cuerpo cilíndrico
- Soporte ABS cromado
- Llave de escuadra LATÓN cromado doble salida
- Embellecedor ACERO INOX Ø50
- Flexible 1,2 m con tuerca de latón cromado

*No incluye latiguillo a cisterna de inodoro



Permite cerrar de una forma independiente el agua a la ducha y al tanque del inodoro.

DUCHA-BIDET



CIERRE AUTOMÁTICO DE AGUA



FLUJO CONTÍNUO DE AGUA



Flexible metalizado

Flexible PVC silver grey

- Longitud 1.2 m
- Tuercas de latón cromado G1/2"
- ANTI-TWIST. Tuerca giratoria que evita torceduras del flexo



CIERRE AUTOMÁTICO DE AGUA



FLUJO CONTÍNUO DE AGUA



Flexible reforzado

Flexible PVC blanco reforzado

- Longitud 1.2 m
- Tuercas de latón cromado G1/2"
- ANTI-TWIST. Tuerca giratoria que evita torceduras del flexo



SERIE ECO

Cod.		€	
70070	Conjunto higiénico de un agua ducha-bidet ABS cromado con soporte de ABS cromado	15,25	-
70060	Conjunto higiénico de un agua ducha-bidet ABS cromado con soporte de ABS cromado y flexible PVC	17,35	-

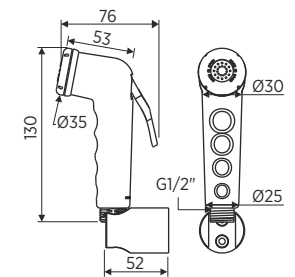

SERIE ECO

Cod.		€	
70030	Conjunto higiénico de un agua ducha-bidet ABS con soporte de ABS	7,10	-
70021	Conjunto higiénico de un agua ducha-bidet ABS con soporte de ABS y flexible PVC	9,40	-

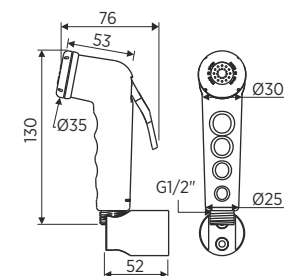

ADVERTENCIA: No dejar la ducha-bidet bajo presión continuada.
 Utilice este producto correctamente, cerrando siempre la llave de paso después de su uso.
 Idrospania no se responsabiliza de daños debidos a un uso incorrecto.



PRODUCTO
NUEVO

Cod.		€	
30425	Flexible PVC BLANCO reforzado Anti-Twist 1,2 m con tuerca de latón cromado	5,90	-



PRODUCTO
NUEVO

Cod.		€	
30426	Flexible PVC SILVER GREY Anti-Twist 1,2 m con tuerca de latón cromado	8,10	-



PRODUCTO
NUEVO

Cod.		€	
30427	Flexible doble grapado ACERO INOX Anti-Twist 1,2 m con tuerca de latón cromado	8,20	-

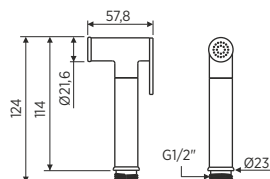

PRODUCTO
NUEVO

Cod.		€	
30463	Ducha-bidet latón cromado	15,30	-



PRODUCTO
NUEVO

Cod.		€	
30459	Recambio cartucho llaves de paso ducha- bidet 70077 y 70078	4,50	-



PRODUCTO
NUEVO



PRODUCTO
NUEVO



PRODUCTO
NUEVO

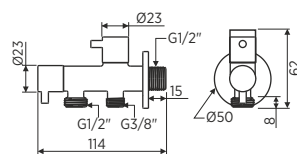

Cod.		€	
30460	Maneta recambio llave de paso mezcladora cromada 70077	7,40	-
30460.NE	Maneta recambio llave de paso mezcladora negro mate 70077.NE	8,40	-

Cod.		€	
30461	Maneta recambio llave de paso mezcladora cromada 70078	13,80	-
30461.NE	Maneta recambio llave de paso mezcladora negro mate 70078.NE	15,90	-

Cod.		€	
30462	Maneta recambio llave de paso mezcladora cromada 70078.NE	7,40	-

Cod.		€	
30632	Llave de escuadra doble salida latón acabado cromado	13,90	-







CISTERNAS

Modelo
SUPER



ABS

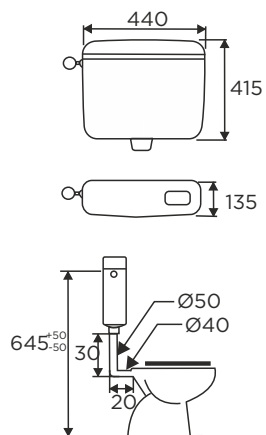

Cod.		€	
40100	Cisterna SEMIALTA completa, con interrupción de descarga equipada con grifo flotador, lateral a derechas o a izquierdas y aislamiento anticondensación y acústico	63,95	5

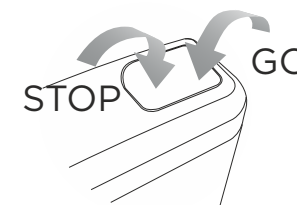

Modelo
SUPER-DUO



ABS

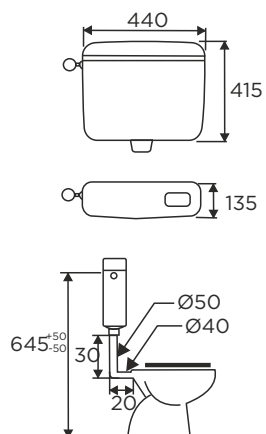

Cod.		€	
40101	Cisterna SEMIALTA completa de doble descarga equipada con grifo flotador, lateral a derechas o a izquierdas y aislamiento anticondensación y acústico	66,95	5

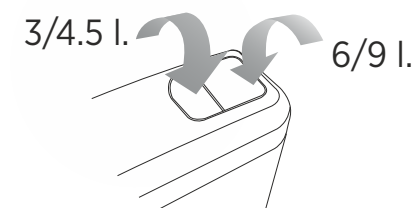

Modelo
LUX-MONOBLOCK



ABS

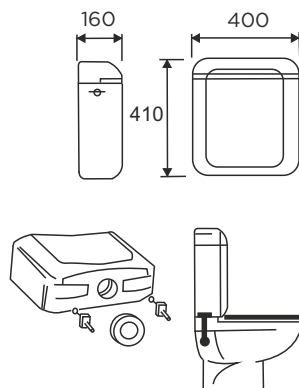

Cod.		€	
40102	Cisterna BAJA completa con interrupción de descarga equipada con grifo flotador, lateral a derechas o a izquierdas y aislamiento anticondensación y acústico	68,95	5

Sistema ajustable desde 135 hasta 280 mm

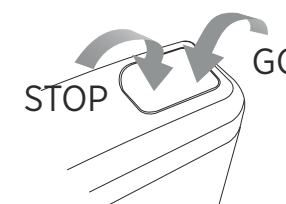
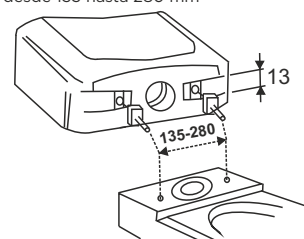



CISTERNA COMPLETA
TANQUE ALTO

CISTERNA COMPLETA TANQUE ALTO

EQUIPAMIENTO WC

ABS



Cod.		€	
40103	Cisterna SEMIALTA - ALTA completa con tapa y CON BAJANTE	52,40	5

- Opción de alimentación por la parte izquierda o posterior
- Fácil instalación y mantenimiento.
- Incluye todos los accesorios para su instalación.
- Incluye bajante.

CUMPLE NORMATIVA UNE-EN 14055

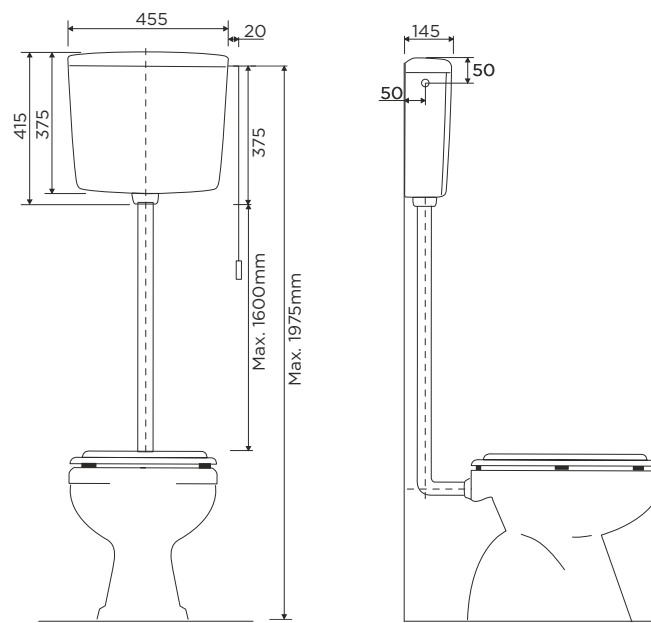

ABS

Cod.		€	
40104	Cisterna SEMIALTA - ALTA completa con tapa SIN BAJANTE	48,20	5

- Opción de alimentación por la parte izquierda o posterior
- Fácil instalación y mantenimiento

CUMPLE NORMATIVA UNE-EN 14055

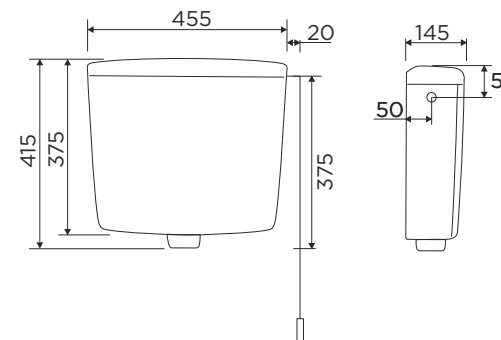



CISTERNA
TANQUE ALTO

CISTERNAS TANQUE ALTO EQUIPAMIENTO WC



PP

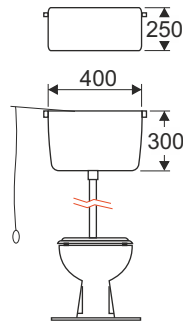

Cod.		€	
40000	Cisterna completa, con grifo lateral convencional, con descargador "A" Capacidad 9 l	27,95	12



PP

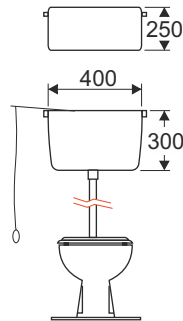

Cod.		€	
40001	Casco de cisterna con base. Capacidad 9 l	17,75	12



ABS

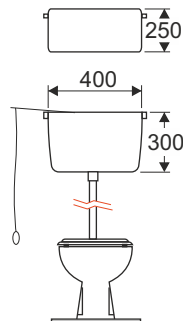



Cod.		€	
40002	Casco de cisterna sin base. Capacidad 9 l	17,75	12



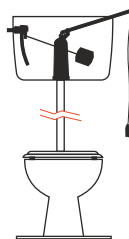

EQUIPAMIENTO TANQUE ALTO

MECANISMOS Y DESCARGADORES TANQUE ALTO EQUIPAMIENTO WC

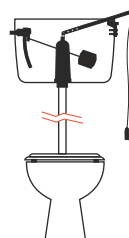

Cod.		€	
28100	Mecanismo completo, para CISTERNA ALTA DE PLÁSTICO con grifo lateral convencional, con descargador "A"	14,45	30



Cod.		€	
28101	Mecanismo completo, para CISTERNA ALTA DE PORCELANA, con grifo lateral convencional, con descargador "A"	16,50	25

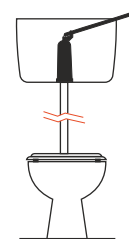

Cod.		€	
28001	Descargador "A" sin base, con soporte y palanca	5,75	60

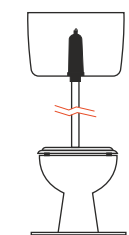

Cod.		€	
28002	Descargador "A", con base	6,30	50

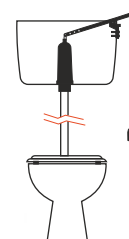

Cod.		€	
28003	Descargador "A" con base, con soporte, palanca, tornillos y cadena	9,80	40



TAPAS



Cod.		Emb.	€	
30701	Asiento de inodoro de PP	CAJA	31,90	9
30701.1		BOX	31,90	18

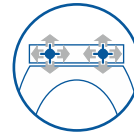

Universal corredera



Adaptable mod. Victoria de Roca y similares



Fabricado en PP

- Peso: 1700 g
- Color: blanco

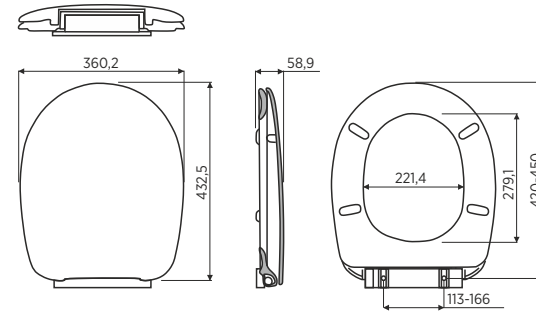

Cod.		Emb.	€	
30702	Asiento de inodoro de PP, con SOFT CLOSE	CAJA	35,90	9
30702.1		BOX	35,90	18

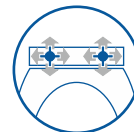

Universal corredera



Soft Close



Adaptable mod. Victoria de Roca y similares



Fabricado en PP

- Peso: 1700 g
- Color: blanco

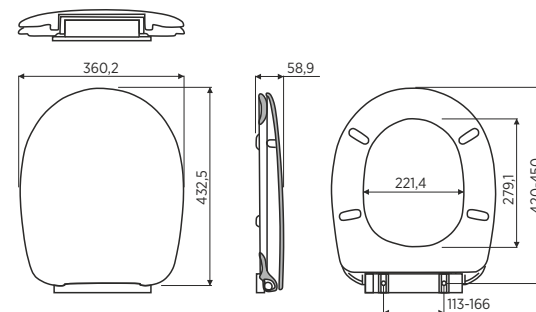

* Las denominaciones son ..marcas registradas por ..compañías no relacionadas con ..H&H IDROSPANIA TECHNIC S.L.

ASIENTOS DE INODORO

EQUIPAMIENTO INODORO



Cod.		Emb.	€	
30703	Asiento de inodoro de DUROPLAST con QUICK	CAJA	40,90	10
30703.1	RELEASE	BOX	40,90	20

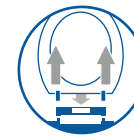

Quick Release

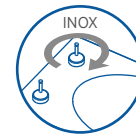

Herrajes ACERO INOX 360°



Fabricado en DUROPLAST



Adaptable mod. Victoria de Roca y similares

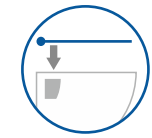

Fijación superior

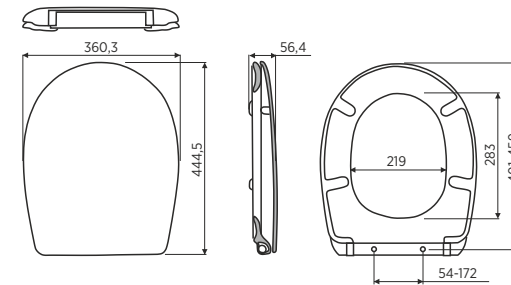

- Peso: 2200 g
- Color: blanco

Cod.		Emb.	€	
30709	Asiento de inodoro SLIM de DUROPLAST con SOFT CLOSE	CAJA	55,90	9
30709.1		BOX	55,90	18

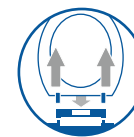

Quick Release

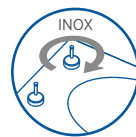

Herrajes ACERO INOX 360°

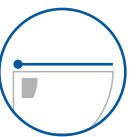

Slim

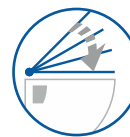

Soft Close



Fabricado en DUROPLAST



Adaptable mod. Victoria de Roca y similares



Fijación superior

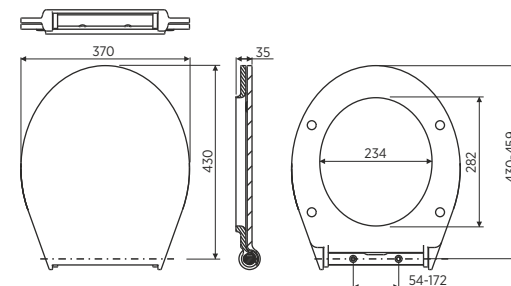

- Peso: 2600 g
- Color: blanco

* Las denominaciones son ..marcas registradas por ..compañías no relacionadas con ..H&H IDROSPANIA TECHNIC S.L.

ASIENTOS DE INODORO

EQUIPAMIENTO INODORO



Cod.		Emb.	€	
30710	Asiento de inodoro compatible con mod. GAP de DUROPLAST,	CAJA	46,95	9
30710.1	con SOFT CLOSE	BOX	46,95	18

Quick Release

Herrajes ACERO INOX 360°

Soft Close

Fabricado en DUROPLAST

Adaptable mod Gap de Roca

Fijación superior

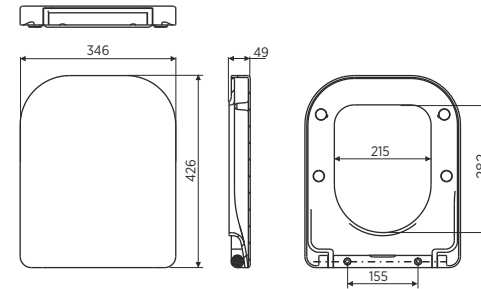

- Peso: 2300 g
- Color: blanco

Cod.		Emb.	€	
30711	Asiento de inodoro SLIM compatible con mod. MERIDIAN de DUROPLAST con SOFT CLOSE	CAJA	45,90	9
30711.1		BOX	45,90	18

Herrajes ACERO INOX 360°

Quick Release

Soft Close

Slim

Adaptable mod Meridian de Roca

Fijación superior

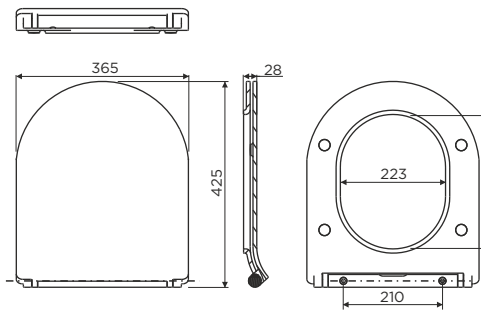

Fabricado en DUROPLAST

- Peso: 2600 g
- Color: blanco

* Las denominaciones son marcas registradas por compañías no relacionadas con H&H IDROSPANIA TECHNIC S.L.

ASIENTOS DE INODORO

EQUIPAMIENTO INODORO

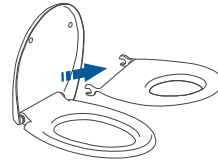

Soft Close



Quick Release



Fabricado en DUROPLAST



Family

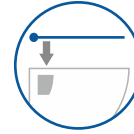

Fijación superior

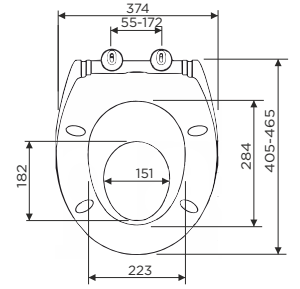

- Peso: 2900 g
- Color: blanco

Cod.		€	
30715	Asiento WC family soft close	68,15	5

Cod.		€	
30716	Asiento WC elevado soft close	82,50	2

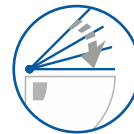

Soft Close



Fabricado en DUROPLAST

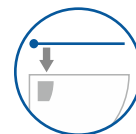

Fijación superior

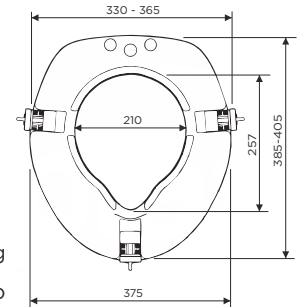

- Peso: 3500 g
- Color: blanco

Cod.		€	
30700	Asiento de inodoro PP UNIVERSAL ECO	14,90	12

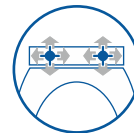

Universal corredera



Adaptable mod. Victoria de Roca y similares



Fabricado en PP

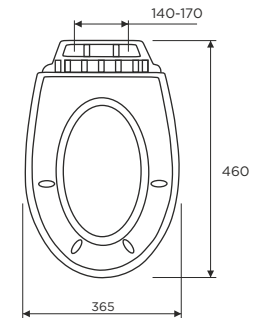

- Peso: 900 g
- Color: blanco

* Las denominaciones son ..marcas registradas por ..compañías no relacionadas con ..H&H IDROSPANIA TECHNIC S.L.

RECAMBIOS DE INODORO EQUIPAMIENTO INODORO



Cod.		€
30705	Kit fijación, herraje nylon ajustable para asientos cod.30701 y cod.30702	3,30
30707	Juego topes aros y asiento PP para asientos cod.30701 y cod.30702	2,10
30706	Kit fijación, herraje universal INOX presión, quick release para asiento cod.30703 y cod.30709	13,80
30708	Juego topes aros y asiento duroplast para asiento cod.30703	2,10
30719	Anclajes fijación tapa WC Family cod.30715	12,70
30720	Kit de 3 uds. de anclajes fijación tapa WC elevada cod.30716	12,70



ASIENTOS DE
DUCHA



Cod.		€	
30717	Asiento de ducha plegable con respaldo	52,70	5

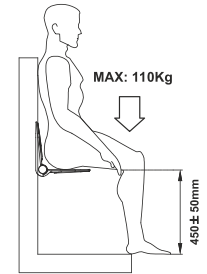

CERTIFICADOS:
 EN 12520: 2010
 EN 1728: 2000
 EN 1022: 2005
 LGA-33 064.01

- Peso: 2380 g
- Color: blanco

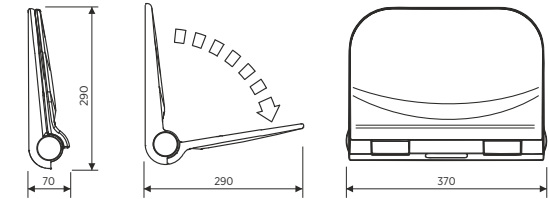

Cod.		€	
30718	Asiento de ducha plegable	96,50	5

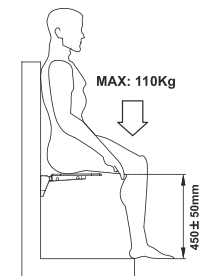

CERTIFICADOS:
 EN 12520: 2010
 EN 1728: 2000
 EN 1022: 2005

- Peso: 2540 g
- Color: blanco-cromo

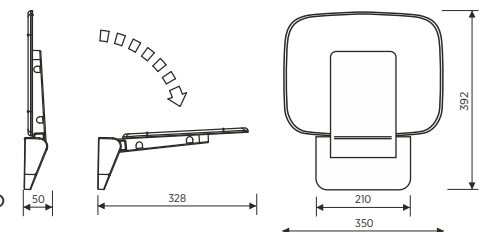



MANGUITOS

MANGUITOS EQUIPAMIENTO WC

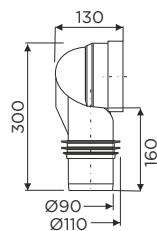

Mat.	Cod.		€	
PP	30510	Manguito conexión inodoro acodado 90° con goma labiada Ø110 mm	13,90	10

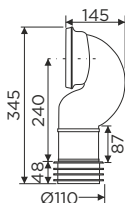

Mat.	Cod.		€	
PP	30523	Manguito conexión inodoro acodado 90° con goma labiada Ø110 mm	13,50	10

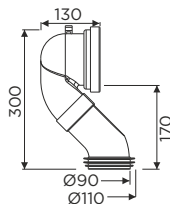

Mat.	Cod.		€	
PP	30514	Manguito conexión inodoro acodado 45° con goma labiada Ø110 mm	12,90	10

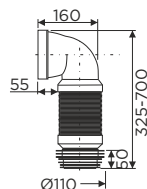

Mat.	Cod.		€	
PP	30513	Manguito conexión inodoro extensible acodado 90° con goma labiada Ø110mm	18,95	10

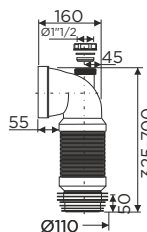

Mat.	Cod.		€	
PP	30522	Manguito conexión inodoro extensible acodado 90° con toma 1"1/2 - 40 mm y goma labiada Ø110 mm	18,75	10

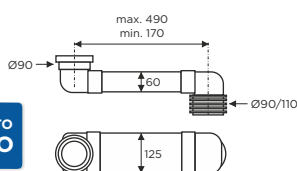

**PRODUCTO
NUEVO**

Mat.	Cod.		€	
PVC	30526	Manguito horizontal conexión ajustable 490-170mm	31,50	-

MANGUITOS

EQUIPAMIENTO WC

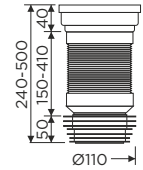
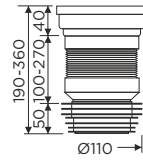

PRODUCTO
NUEVO

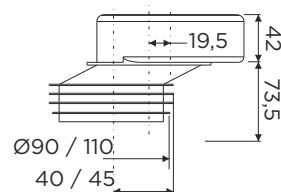
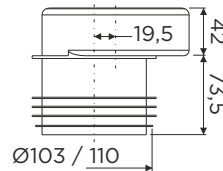
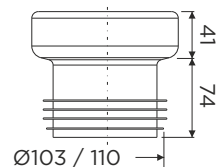
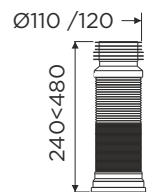
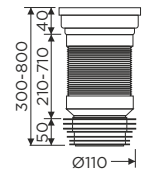

Mat.	Cod.		€	
PP	30521	Manguito conexión inodoro extensible 190-360 mm MINI con goma labiada Ø110 mm	14,45	18

Mat.	Cod.		€	
PP	30524	Manguito conexión inodoro extensible 240-500 mm con goma labiada Ø110 mm	14,90	15

Mat.	Cod.		€	
PP	30527	Manguito conexión inodoro extensible 300-800 mm con goma labiada Ø110 mm	15,50	15

Mat.	Cod.		€	
PP	30511	Manguito conexión inodoro extensible 240-480 mm con goma labiada Ø110-120 mm	15,50	15

Mat.	Cod.		€	
EVA	30508	Manguito conexión inodoro recto elástico, Ø110 mm	3,65	30

Mat.	Cod.		€	
EVA	30509	Manguito conexión inodoro excéntrico elástico, Ø110 mm	3,65	30

Mat.	Cod.		€	
PP	30512	Manguito elástico Superexcéntrico	5,45	22

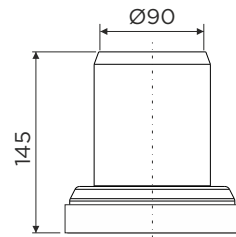

Mat.	Cod.		€	
PVC	30500	Manguito conexión inodoro recto, Ø90 mm	4,55	36

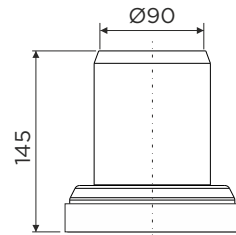

Mat.	Cod.		€	
PP	30501	Manguito conexión inodoro recto, Ø90 mm	4,30	36

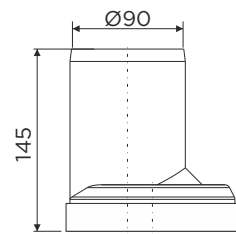

Mat.	Cod.		€	
PVC	30502	Manguito conexión inodoro excéntrico, Ø90 mm	4,55	36

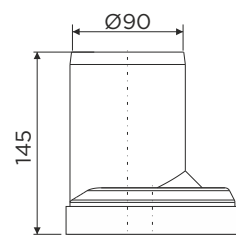

Mat.	Cod.		€	
PP	30503	Manguito conexión inodoro excéntrico, Ø90 mm	4,30	36

MANGUITOS

EQUIPAMIENTO WC

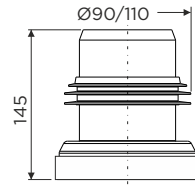

Mat.	Cod.		€	
PVC	30504	Manguito conexión inodoro recto, Ø90 mm, con goma labiada Ø110 mm	5,60	36

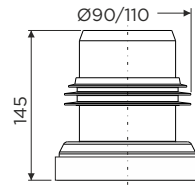

Mat.	Cod.		€	
PP	30505	Manguito conexión inodoro recto, Ø90 mm, con goma labiada Ø110 mm	5,20	36

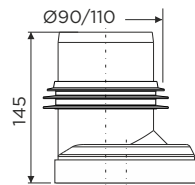

Mat.	Cod.		€	
PVC	30506	Manguito conexión inodoro excéntrico, Ø90 mm, con goma labiada Ø110 mm	5,60	36

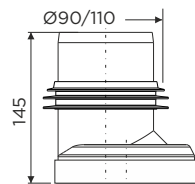

Mat.	Cod.		€	
PP	30507	Manguito conexión inodoro excéntrico, Ø90 mm, con goma labiada Ø110 mm	5,20	36

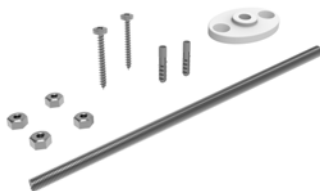

Cod.		€	
30011	Conjunto fijación manguito dual	3,75	-



PIEZAS DE
RECAMBIO

GOMAS TANQUE BAJO EQUIPAMIENTO WC

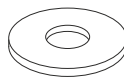

65,6x32x3mm



74x23x3mm





68x17x3,2mm



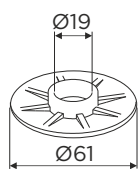
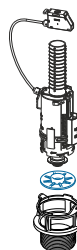
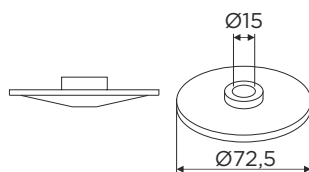

65x18x3mm





Cod.		€	Embalaje	
30210	Goma de cierre descargador T.B. Tipo Victoria	1,10	Granel	100/caja

Cod.		€	Embalaje	
30211	Goma de cierre sin cuello para descargador cisterna baja	1,10	Granel	100/caja

Cod.		€	Embalaje	
30212	Goma de cierre con cuello para descargador cisterna baja	1,10	Granel	50/caja

Cod.		€	Embalaje	
30218	Goma cierre T.B. nuevo tubo estrecho	1,00	Granel	100/caja

Cod.		€	Embalaje	
30223	Goma cierre cónica descargador universal cisterna baja	1,20	Granel	50/caja

Cod.		€	Embalaje	
30200	Goma cierre descargadores modelo Denia Plus, Denia, Loja, Javea y Palma	1,25	Granel	50/caja

GOMAS TANQUE BAJO

EQUIPAMIENTO WC

Ø111

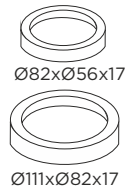
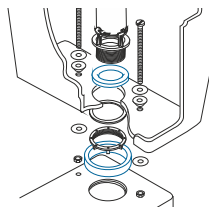

Ø111

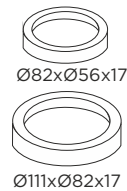
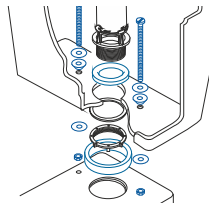

PRODUCTO
NUEVO

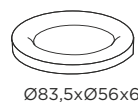
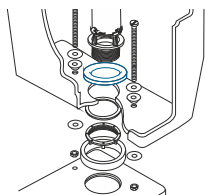
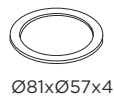
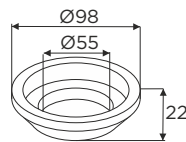
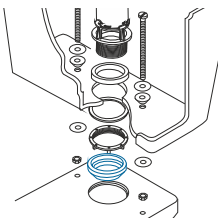

Cod.		€	Embalaje	
30231	Conjunto goma asiento espuma Øext 111 mm T.B + goma base T.B.	1,50	Granel	50/bolsa

Cod.		€	Embalaje	
30431	Conjunto goma asiento espuma Øext 111 mm T.B + goma base T.B. + tornillos HB M6x90	3,30	Bolsa	25/bolsa

30432	Conjunto goma asiento espuma Øext 111 mm T.B + goma base T.B. + tornillos INOX M6x90	3,90	Bolsa	25/bolsa
-------	--	------	-------	----------

Cod.		€	Embalaje	
30216	Goma asiento caucho	1,85	Granel	25/bolsa

Cod.		€	Embalaje	
30208	Goma estanqueidad base rosca tradicional	1,15	Granel	25/bolsa

Cod.		€	Embalaje	
30209	Goma base PVC T.B.	1,05	Granel	25/bolsa

GOMAS ENCHUFE EQUIPAMIENTO WC

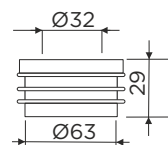
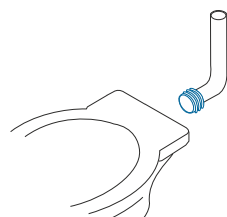

Mat.	Cod.		€	Embalaje	
75% NR 25% SBR	30213	Goma de enchufe interior inodoro	2,05	Granel	50/bolsa

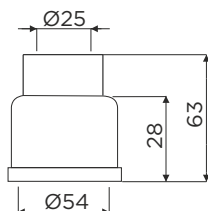
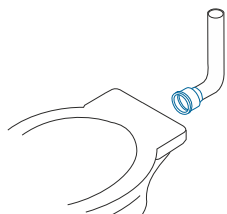

Mat.	Cod.		€	Embalaje	
75% NR 25% SBR	30214	Goma de enchufe exterior inodoro Ø25	1,75	Granel	50/bolsa

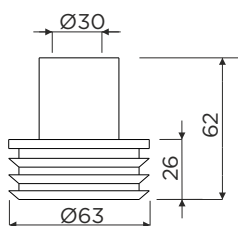
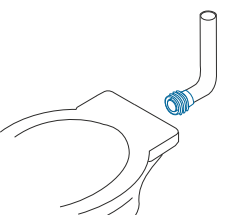

Mat.	Cod.		€	Embalaje	
75% NR 25% SBR	30219	Goma de enchufe interior inodoro con cuello Mod. Victoria	1,90	Granel	50/bolsa

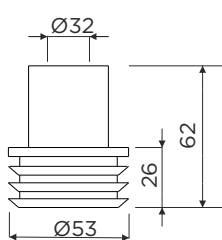
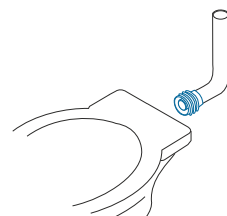

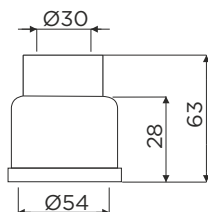
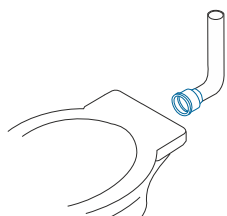

Mat.	Cod.		€	Embalaje	
75% NR 25% SBR	30220	Goma de enchufe interior inodoro con cuello Mod. Lucerna	1,80	Granel	50/bolsa



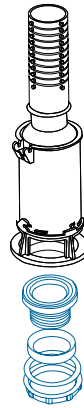

Mat.	Cod.		€	Embalaje	
75% NR 25% SBR	30222	Goma de enchufe exterior inodoro Ø30	1,55	Granel	50/bolsa

RECAMBIOS EQUIPAMIENTO WC

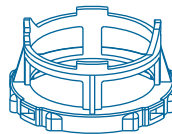
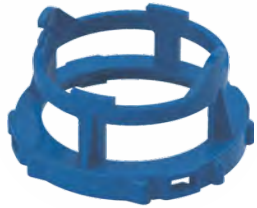

Cod.		€	Embalaje	
30104	Base rosca tradicional de tanque bajo completa	2,40	Granel	25/bolsa



Cod.		€	Embalaje	
30109	Base descargador sistema bayoneta	1,25	Granel	25/bolsa

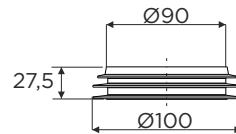
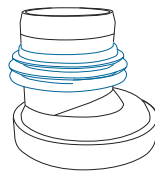

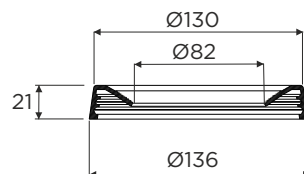
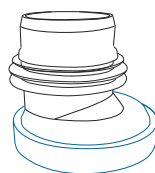

Cod.		€	Embalaje	
30221	Goma manguito interior labiada Ø 90/Ø110 mm	1,55	Granel	25/bolsa



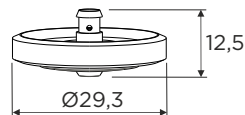
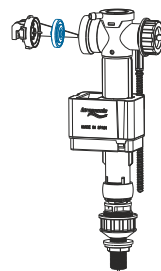

Cod.		€	Embalaje	
30226	Goma manguito conexión inodoro	2,80	Granel	25/bolsa

GOMAS FLOTADORES EQUIPAMIENTO WC

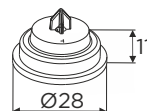
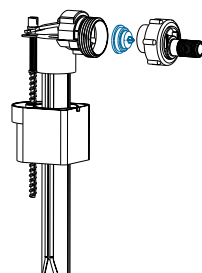

Cod.		€	Embalaje	
30230	Goma de cierre para grifos modelo "Duo"	1,65	Granel	10/bolsa



Cod.		€	Embalaje	
30201	Conjunto membrana cierre grifo lateral "Servo"	1,65	Granel	10/bolsa

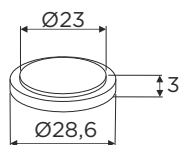
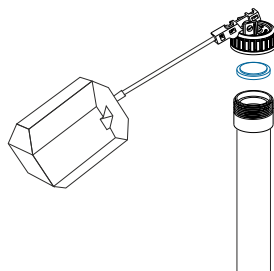

Cod.		€	Embalaje	
30202	Goma de cierre grifos Mod. "Ana" y "Lina"	0,80	Granel	25/bolsa

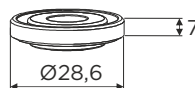

Cod.		€	Embalaje	
30204	Conjunto membrana cierre grifo inferior "Servo"	1,00	Granel	10/bolsa

RECAMBIOS TANQUE ALTO

EQUIPAMIENTO WC



PVC

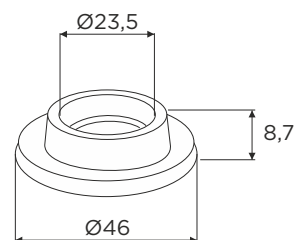
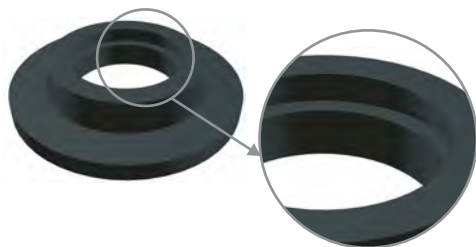
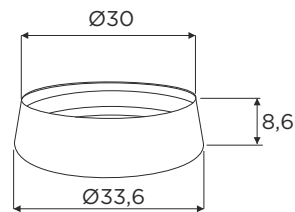
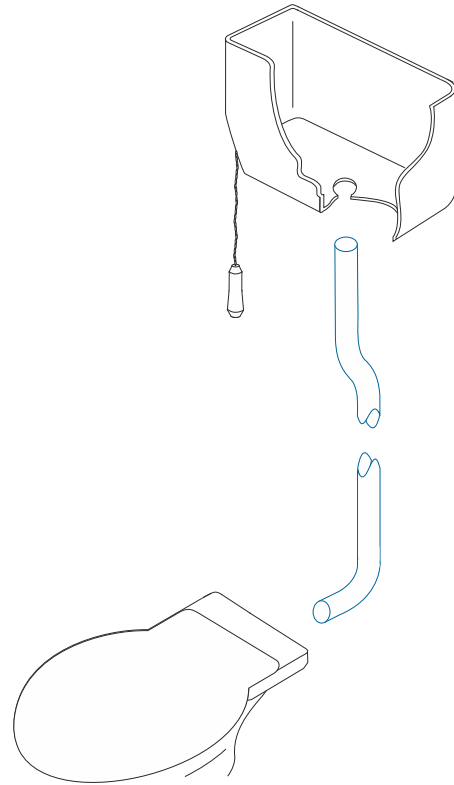

Cod.

€



30402

Bajante exterior en dos piezas
Ø32mm L=180 cm completa con
curva y codo

8,70

20

Cod.

€

Embalaje



30215

Junta cónica 1"1/4x32

0,60

Granel

50/bolsa

Cod.

€

Embalaje



30207

Goma cierre descargador "A"

1,15

Granel

50/bolsa

RECAMBIOS TANQUE ALTO EQUIPAMIENTO WC



Cod.		€	Embalaje	
30050	Conjunto cadena tirador cisterna alta 75cm	1,85	Bolsa	10/bolsa



Cod.		€	Embalaje	
30051	Palanca con soporte metálico para cisterna alta	3,95	Granel	10/bolsa



Cod.		€	Embalaje	
30052	Palanca larga desc. "A" para cisterna de porcelana	2,65	Granel	10/bolsa



Cod.		€	Embalaje	
30053	Palanca corta desc. "A" para cisterna de plástico	1,60	Granel	10/bolsa

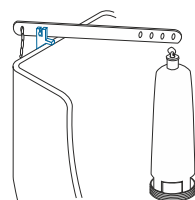

Cod.		€	Embalaje	
30101	Soporte palanca desc. "A" para cisterna de porcelana	1,50	Granel	25/bolsa

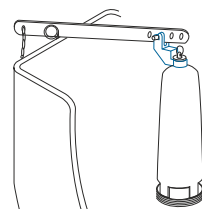

Cod.		€	Embalaje	
30102	Soporte palanca desc. "A" para cisterna alta de plástico	1,00	Granel	25/bolsa

PIEZAS DE RECAMBIO

EQUIPAMIENTO WC



ABS
CROMADO

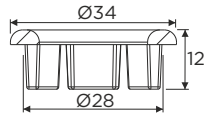
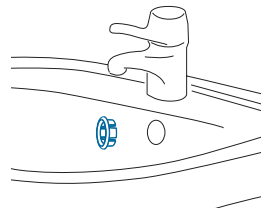

Cod.		€	Embalaje	
30617	Embelledor cromado lavabo Ø28	1,05	Granel	50/bolsa



ABS
CROMADO

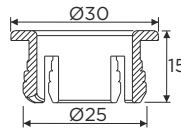
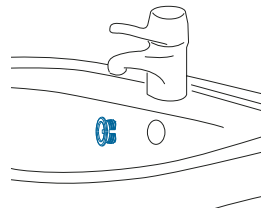

Cod.		€	Embalaje	
30618	Embelledor cromado lavabo Ø24	1,05	Granel	50/bolsa



ABS
CROMADO

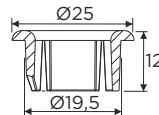
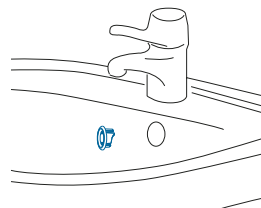

Cod.		€	Embalaje	
30619	Embelledor cromado lavabo Ø18	1,00	Granel	50/bolsa



ABS
CROMADO

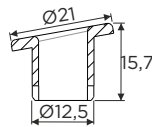
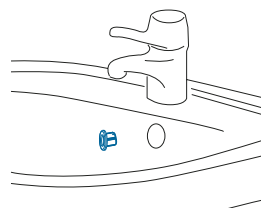

Cod.		€	Embalaje	
30620	Embelledor cromado lavabo Ø14	1,00	Granel	50/bolsa

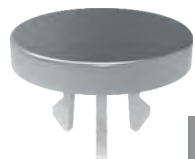

ABS
CROMADO

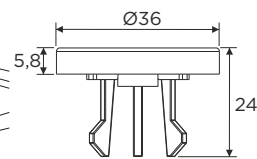
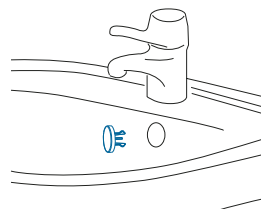

Cod.		€	Embalaje	
30621	Tapón embellecedor cromado lavabo Ø23-Ø26	2,20	Granel	50/bolsa



PP

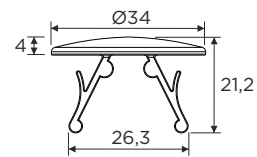
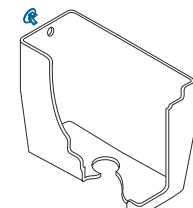

Cod.		€	Embalaje	
30100	Tapón embellecedor 3/8" y 1/2" blanco	0,65	Granel	50/bolsa



ABS
CROMADO

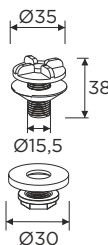
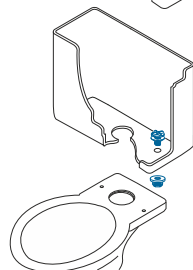

Cod.		€	Embalaje	
30400	Tapón obturador inferior cisterna	1,55	Granel	50/bolsa

RECAMBIOS, TORNILLOS EQUIPAMIENTO WC



Cod.		€	Embalaje	
30000	Tornillos Hierro Bricomatado taza-cisterna baja M6 x 90	1,80	Bolsa	25/bolsa

Cod.		€	Embalaje	
30005	Tornillos INOX. taza-cisterna baja M6 x 90. Arandelas plástico	2,40	Bolsa	25/bolsa

Cod.		€	Embalaje	
30015	Tornillos INOX. taza-cisterna baja M6 x 90. Arandelas INOX	3.30	Bolsa	25/bolsa

Cod.		€	Embalaje	
30001	Tornillos fijación para lavabos HIERRO ZINCADO M10 x 110	2,05	Bolsa	25/bolsa

Cod.		€	Embalaje	
30002	Tornillos verticales de Hierro Bricomatado fijación para inodoro M5 x 75	1,30	Bolsa	25/bolsa

Cod.		€	Embalaje	
30003	Tornillos verticales de LATÓN fijación para inodoro M5 x 75	2,30	Bolsa	25/bolsa

Cod.		€	Embalaje	
30004	Tornillos horizontales Hierro Bricomatado para inodoro M5 x 75	1,65	Bolsa	25/bolsa

RECAMBIOS, TORNILLOS

EQUIPAMIENTO WC



INOX

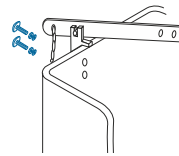

Cod.		€	Embalaje	
30006	Tornillos INOX. sujeción palanca T.A. M3/16x40	0,80	Bolsa	25/bolsa



HZ

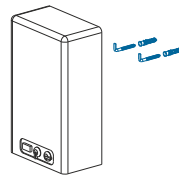

Cod.		€	Embalaje	
30007	Set de fijación alcayatas para calentadores HIERRO ZINCADO 10x75	1,75	Bolsa	25/bolsa



HZ

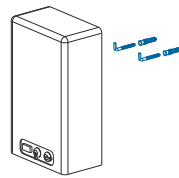

Cod.		€	Embalaje	
30009	Set de fijación alcayatas para calentadores HIERRO ZINCADO 8x65	1,60	Bolsa	25/bolsa



HZ

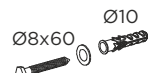
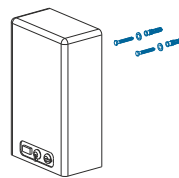

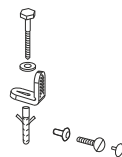
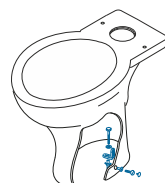

Cod.		€	Embalaje	
30010	Set de fijación tornillo hexagonal para calentadores HIERRO ZINCADO 8x60	1,15	Bolsa	25/bolsa

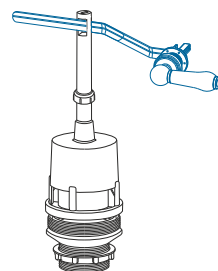
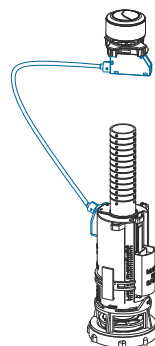
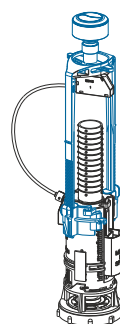
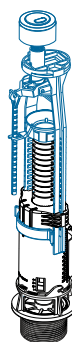

Cod.		€	Embalaje	
30616	Juego tornillos fijación inodoro con soporte nylon horizontal y tapones cromados	3,30	Bolsa	25/bolsa



Cod.		€	Embalaje	
30300	Kit fijación tapa pulsador doble descarga mod. Palma Ø16 mm / Ø40 mm	5,50	Bolsa	10/bolsa

Cod.		€	Embalaje	
30325	Kit fijación tapa pulsador doble descarga mod. Denia Plus Ø16 mm / Ø40 mm	6,85	Bolsa	10/bolsa

Cod.		€	Embalaje	
30317	Conjunto accionamiento cable descargador mod. Denia, Denia Plus y Javea Ø16 mm / Ø40 mm	4,10	Bolsa	10/bolsa

Cod.		€	Embalaje	
30323	Palanca accionamiento frontal manecilla porcelana cerámica	17,33	Bolsa	5/bolsa

RECAMBIOS PULSADORES

EQUIPAMIENTO WC



PRODUCTO NUEVO



PRODUCTO NUEVO

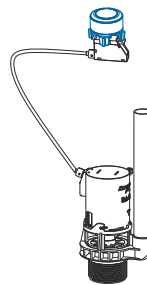
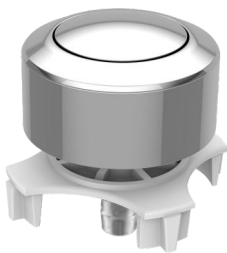
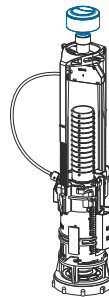
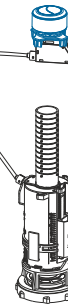

PRODUCTO NUEVO

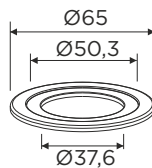
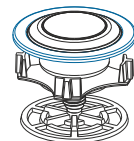
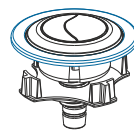

Cod.	€	Embalaje	
30310	3,70	Bolsa	25/bolsa

Conjunto pulsador cromado, descargador interrumpible Loja Ø12 mm / Ø40 mm			
30310.NE	4,10	Bolsa	25/bolsa

Cod.	€	Embalaje	
30314	3,70	Bolsa	25/bolsa

Conjunto pulsador doble descarga por cable, descargador Denia Ø16 mm / Ø40 mm			
30314.NE	4,10	Bolsa	25/bolsa

Cod.	€	Embalaje	
30321	3,05	Bolsa	25/bolsa

Cod.	€	Embalaje	
30315	3,15	Bolsa	25/bolsa

Cod.	€	Embalaje	
30319	1,30	Bolsa	25/bolsa

Conjunto pulsador simple por cable descargador Javea Ø16 mm / Ø40 mm			
30319.NE	1,40	Bolsa	25/bolsa

Adaptador cromado pulsadores para orificios de Ø60 mm			
Adaptador Negro mate pulsadores para orificios de Ø60 mm			

RECAMBIOS TIRADORES

EQUIPAMIENTO WC



ABS

Cod.		€	Embalaje	
30305	Tirador UNIVERSAL ABS cromado con varilla metálica recta	3,45	Bolsa	25/bolsa



ABS

Cod.		€	Embalaje	
30306	Tirador ABS cromado con varilla metálica en ángulo	3,30	Bolsa	25/bolsa



METAL

Cod.		€	Embalaje	
30308	Tirador pomo metálico cromado con varilla metálica recta	5,95	Bolsa	25/bolsa



METAL

Cod.		€	Embalaje	
30309	Tirador pomo metálico cromado con varilla metálica en ángulo	5,95	Bolsa	25/bolsa

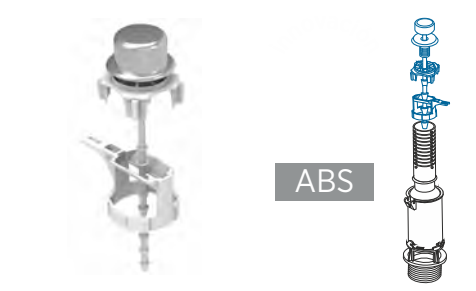

ABS

Cod.		€	Embalaje	
30304	Tirador ABS cromado para mod. Alcora	2,55	Bolsa	10/bolsa

RECAMBIOS CISTERNA SEMI-ALTA, BAJA EQUIPAMIENTO WC

Modelo / Modelo
SUPER / SUPER-DUO

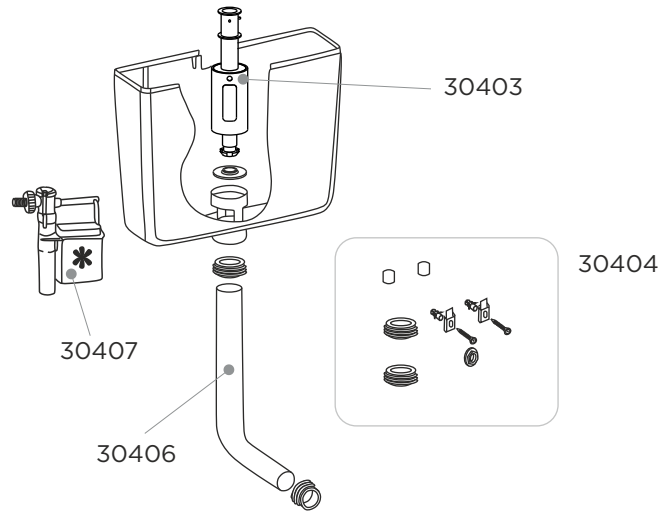

Modelo
LUX-MONOBLOCK

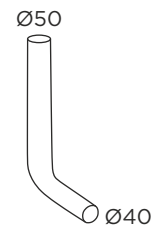
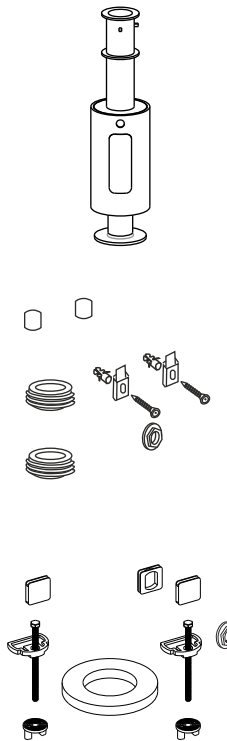
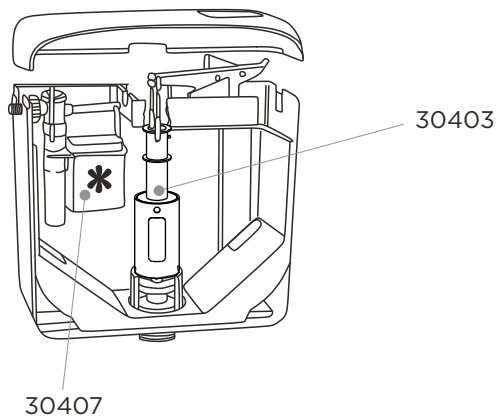

Cod.		€	
30403	Descargador para cisterna SUPER, SUPER-DUO y LUX-MONOBLOCK con goma de cierre	15,95	-

Cod.		€	
30404	Kit de complementos para cisternas semi-altas SUPER y SUPER-DUO	10,90	-

Cod.		€	
30405	Kit de complementos para cisterna baja LUX-MONOBLOCK	11,50	-

Cod.		€	
30406	Codo para cisternas semi-altas SUPER y SUPER-DUO	8,30	-

Cod.		€	
30407	Grifo alimentación lateral para cisternas SUPER, SUPER-DUO y LUX-MONOBLOCK	15,50	-

Cod.		€	
30408	Tapa cisterna modelo Super 40100	19,50	-
30409	Tapa cisterna modelo Super-Duo 40101	20,90	-
30410	Tapa cisterna modelo Lux-Monoblock 40102	20,90	-

Nos adaptamos a tus necesidades

En Idrospania contamos con distintos formatos de presentación para nuestros productos, de forma que puedas elegir según tus necesidades

Consultar condiciones

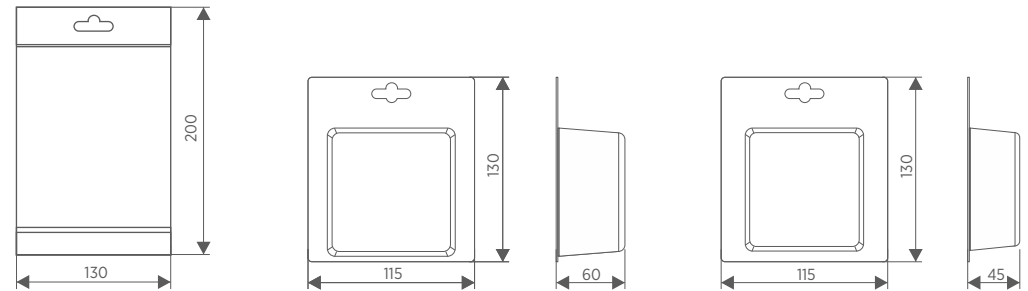

FORMATO
BOLSA



FORMATO
BLISTER



CLICK-CLACK Y
SIFONES LATÓN CROMADO



VÁLVULAS CLICK-CLACK
CARACTERÍSTICAS

TOTALMENTE FABRICADA EN LATÓN

SISTEMA CLICK-CLACK ANTICALCÁREO

Goma inferior válvula
1. Espuma
2. PVC transparente

Junta de cierre NBR90° de alta calidad

Mecanismo de cierre de latón con muelle inoxidable

UNIVERSAL: Adaptable a lavabos con/sin rebosadero
Altura del cuerpo regulable max 70 mm

Rosca 1"1/4
*(Posibilidad de convertidor de
rosca 1"1/2 ref. 30615 pág. 145)

TORNILLO INOXIDABLE

*(Posibilidad de adaptador extensible con rebosadero ref. 660518 pág. 119)

** (Recambios en pág. 116)

VÁLVULAS CLICK-CLACK CROMADAS

SIFONES Y VÁLVULAS

TODOS LOS MODELOS SE PRESENTAN EN CAJA INDIVIDUAL

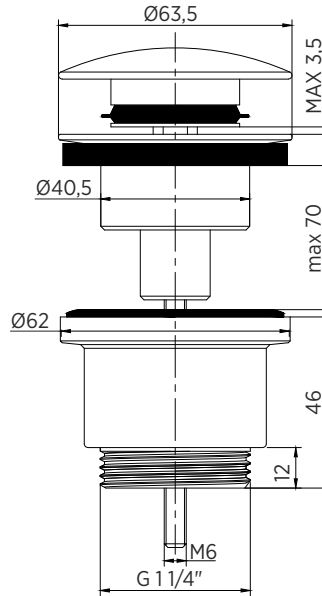

Ref.	Cod.		€	
I-203	30611	Válvula latón cromado click-clack. Tapón exterior grande Ø63	13,20	50

COMPLETA

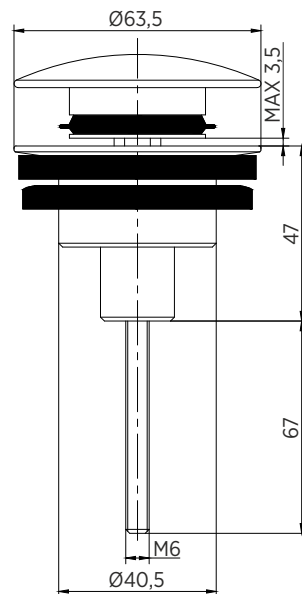

Ref.	Cod.		€	
I-207	30624	Conjunto superior latón cromado click-clack. Tapón exterior grande Ø63	10,45	50

RECAMBIO

Transforma su válvula convencional en sistema click-clack



VÁLVULAS CLICK-CLACK CROMADAS

SIFONES Y VÁLVULAS

TODOS LOS MODELOS SE PRESENTAN EN CAJA INDIVIDUAL

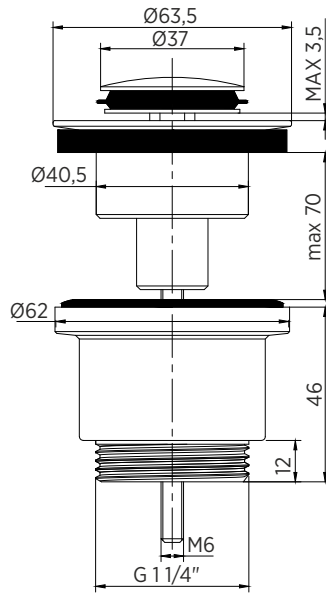

Ref.	Cod.		€	
I-201	30607	Válvula latón cromado click-clack. Tapón interior pequeño Ø37	12,95	50

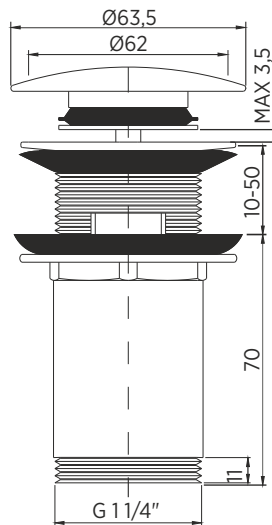



Ref.	Cod.		€	
I-202	30608	Válvula latón cromado larga click-clack. Tapón exterior grande Ø63	13,95	50

VÁLVULAS CLICK-CLACK LAVABO-BIDET

SIFONES Y VÁLVULAS

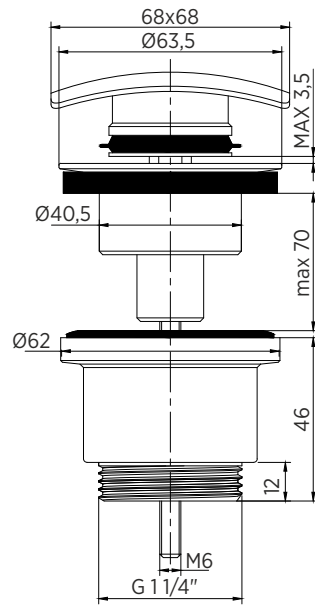
TODOS LOS MODELOS SE PRESENTAN EN CAJA INDIVIDUAL



Ref.	Cod.		€	
I-204	30612	Válvula latón cromado click-clack. Tapón exterior cuadrado	15,75	50

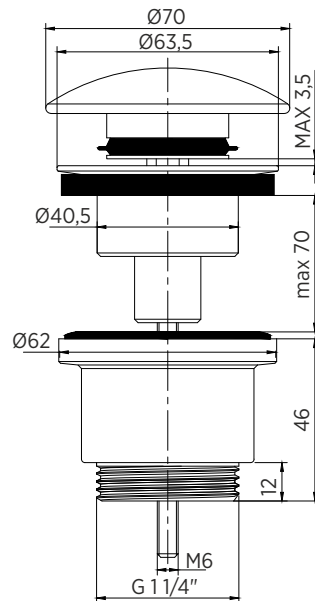

Ref.	Cod.		€	
I-208	30625	Válvula latón cromado click-clack. Tapón exterior PORCELANA CERÁMICA COLOR BLANCO	16,80	50



SIFONES CROMADOS

SIFONES Y VÁLVULAS

TODOS LOS MODELOS SE PRESENTAN EN CAJA INDIVIDUAL



Ref.	Cod.		€	
I-215	30600	Sifón botella LATÓN cromado diseño minimalista cilíndrico Embalaje LUXE	34,25	-
I-215	30600.Z	Sifón botella ZINC cromado diseño minimalista cilíndrico	29,90	-

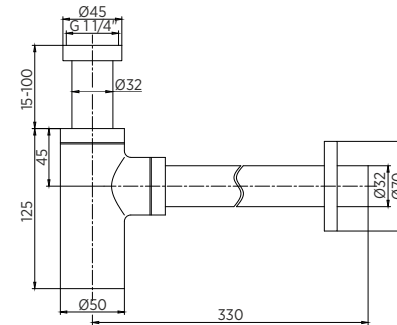

Ref.	Cod.		€	
I-205	30622	Sifón botella LATÓN cromado diseño minimalista cuadrado Embalaje LUXE	45,15	-

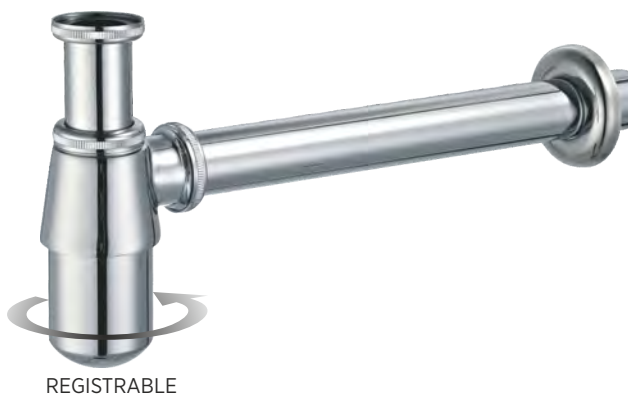
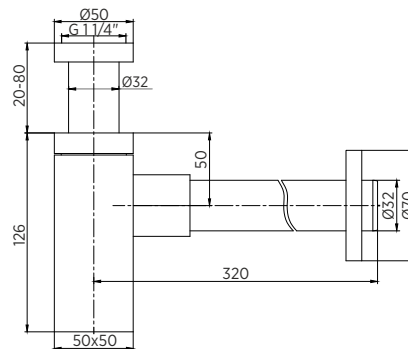

Ref.	Cod.		€	
I-212	30602	Sifón botella LATÓN cromado	20,95	-
I-212	30602.Z	Sifón botella ZINC cromado	17,95	-

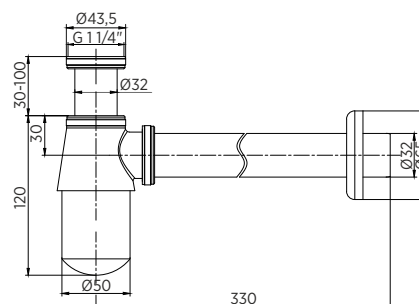

*(Recambios en pág. 128)

TODOS LOS MODELOS SE PRESENTAN EN CAJA INDIVIDUAL

PRODUCTO
NUEVO

Ref.	Cod.		€	
I-215	30636	Sifón botella LATÓN cromado diseño minimalista cilíndrico ahorro de espacio	66,90	-

Embalaje LUXE

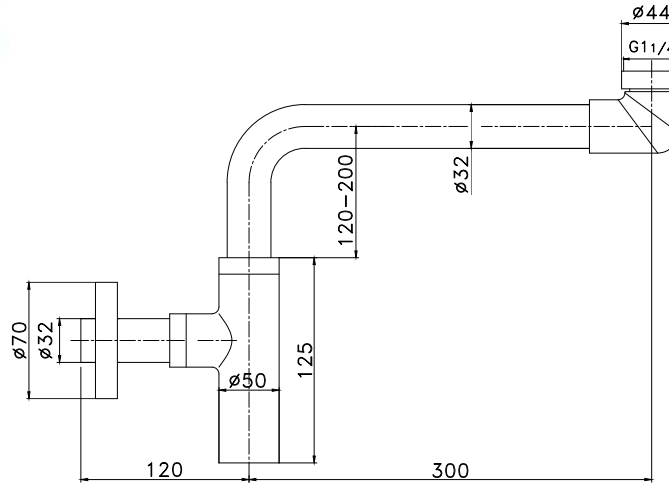

CAJAS
SIFONES
LUXE





CLICK-CLACK Y
SIFONES ACABADOS ESPECIALES

TODOS LOS MODELOS SE PRESENTAN EN CAJA INDIVIDUAL



Cod.		€	
30611.NE	Válvula click-clack latón. Acabado NEGRO MATE . Tapón exterior grande Ø63	23,90	50



Cod.		€	
30611.BLM	Válvula click-clack latón. Acabado BLANCO MATE . Tapón exterior grande Ø63	23,90	50



Cod.		€	
30611.CO	Válvula click-clack latón. Acabado COBRE CEPILLADO . Tapón exterior grande Ø63	22,50	50

VÁLVULAS CLICK-CLACK

ACABADOS ESPECIALES

TODOS LOS MODELOS SE PRESENTAN EN CAJA INDIVIDUAL



Cod.		€	
30611.NI	Válvula click-clack latón. Acabado NÍQUEL INOX CEPILLADO . Tapón exterior grande Ø63	22,50	50



Cod.		€	
30611.ORO	Válvula click-clack latón. Acabado ORO . Tapón exterior grande Ø63	22,50	50



Cod.		€	
30611.BRV	Válvula click-clack latón. Acabado BRONCE VIEJO CEPILLADO . Tapón exterior grande Ø63	22,50	50

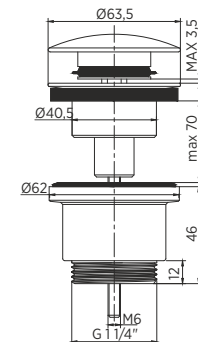

*(Recambios en pág. 128)

TODOS LOS MODELOS SE PRESENTAN EN CAJA INDIVIDUAL



Cod.		€	
30600.NE	Sifón botella latón. Acabado NEGRO MATE . Diseño minimalista cilíndrico	63,90	-

*(Recambios en pág. 128)



Cod.		€	
30600.BLM	Sifón botella latón. Acabado BLACO MATE . Diseño minimalista cilíndrico	63,90	-



Cod.		€	
30600.CO	Sifón botella latón. Acabado COBRE CEPILLADO . Diseño minimalista cilíndrico	55,50	-

SIFONES
ACABADOS ESPECIALES

TODOS LOS MODELOS SE PRESENTAN EN CAJA INDIVIDUAL



Cod.		€	
30600.NI	Sifón botella latón. Acabado NÍQUEL INOX CEPILLADO . Diseño minimalista cilíndrico	55,50	-



Cod.		€	
30600.ORO	Sifón botella latón. Acabado ORO . Diseño minimalista cilíndrico	55,50	-



Cod.		€	
30600.BRV	Sifón botella latón. Acabado BRONCE VIEJO CEPILLADO . Diseño minimalista cilíndrico	55,50	-

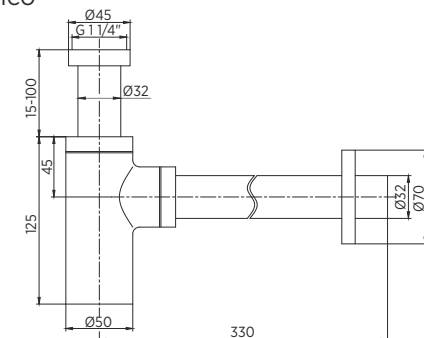





RECAMBIOS CLICK-CLACK
Y SIFONES



Cod.		€	
30629	Tubo para sifón botella latón longitud 300 mm acabado CROMADO	5,20	50
30629.NE	Tubo para sifón botella latón longitud 300 mm acabado NEGRO MATE	8,50	50
30629.BLM	Tubo para sifón botella latón longitud 300 mm acabado BLANCO MATE	6.40	50
30629.CO	Tubo para sifón botella latón longitud 300 mm acabado COBRE CEPILLADO	6.40	50
30629.NI	Tubo para sifón botella latón longitud 300 mm acabado NÍQUEL INOX CEPILLADO	6.40	50
30629.ORO	Tubo para sifón botella latón longitud 300 mm acabado ORO	6.40	50
30629.BRV	Tubo para sifón botella latón longitud 300 mm acabado BRONCE VIEJO CEPILLADO	6.40	50



Cod.		€	
30416	Goma cierre valvulas click-clack	0,60	50
30417	Junta PVC valvulas click-clack	0,75	50
30418	Junta goma espuma valvulas click-clack	0,55	50
30419	Mecanismo interior valvulas click clack de tapón exterior grande	2,90	50



SIFÓN LAVABO BIDET

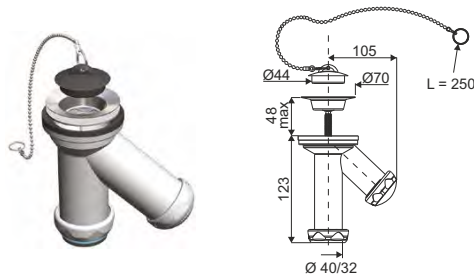

EASYFIT

Ref.	Cod.		€	
I-01	660401	Sifón "Y" compacto, válvula lavabo-bidet, con salida Ø40 mm, y junta cónica reductora Ø32 mm	6,10	50

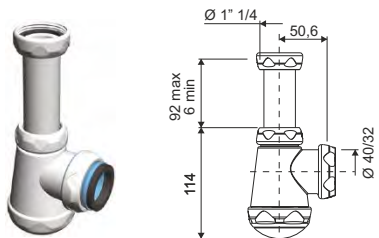

Ref.	Cod.		€	
I-02	660402	Sifón botella corto extensible, salida horizontal Ø40 mm, con reductora Ø32 mm, racor 1" 1/4 para lavabo-bidet	4,05	80

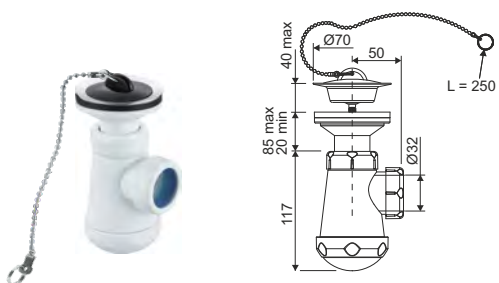

Ref.	Cod.		€	
I-03	660403	Sifón botella corto extensible, salida horizontal Ø32 mm, válvula lavabo-bidet 1" 1/4 x 70	6,10	65

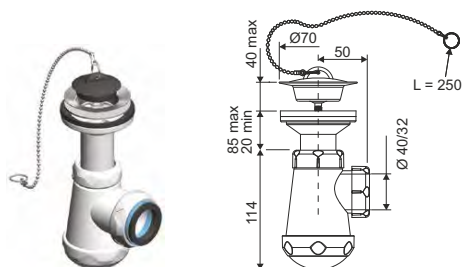

EASYFIT

Ref.	Cod.		€	
I-03	660403.E	Sifón botella corto extensible, salida horizontal Ø40 mm, con reductora Ø32 mm, válvula lavabo-bidet 1" 1/4 x 70	6,70	60

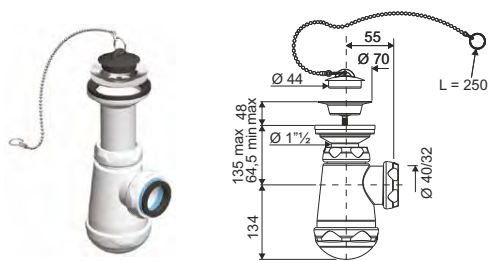

EASYFIT

Ref.	Cod.		€	
I-04	660404	Sifón botella extensible, salida horizontal Ø40 mm, con reductora Ø32 mm, válvula lavabo-bidet 1" 1/2 x 70	6,85	45

LAVABO-BIDET

SIFONES Y VÁLVULAS

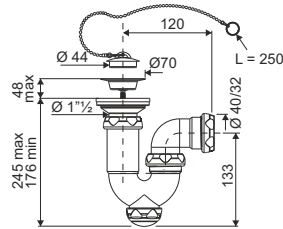

EASYFIT

Ref.	Cod.		€	
I-05	660405	Sifón curvo extensible, salida horizontal Ø40 mm, con reductora Ø32 mm, válvula lavabo-bidet 1" 1/2 x70	6,85	40

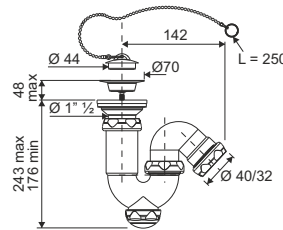

EASYFIT

Ref.	Cod.		€	
I-06	660406	Sifón curvo extensible, salida inclinada Ø40 mm, con reductora Ø32 mm, válvula lavabo-bidet 1" 1/2 x 70	6,85	35

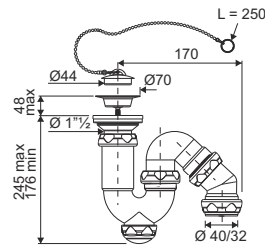

EASYFIT

Ref.	Cod.		€	
I-07	660407	Sifón curvo extensible, salida orientable Ø40 mm, con reductora Ø32 mm, válvula lavabo-bidet 1" 1/2 x 70	7,35	30

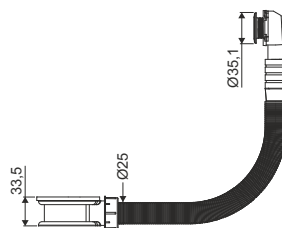



Ref.	Cod.		€	
I-270	660518	Adaptador extensible para lavabos con rebosadero redondo ABS CROMADO. SIN VÁLVULA	3,60	50

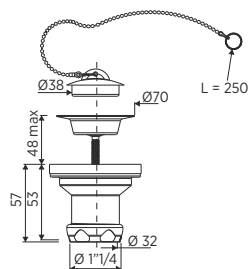

EASYFIT

Ref.	Cod.		Emb.	€	
I-60	660435.E	Válvula lavabo-bidet 1" 1/4 x 70	BOLSA	4,45	65



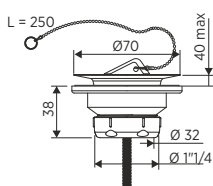

Ref.	Cod.		Emb.	€	
I-60	660435	Válvula lavabo-bidet 1" 1/4 x 70	BOLSA	3,50	65
I-272	660520		BLISTER	4,30	85



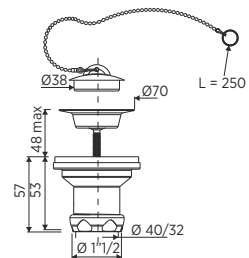

EASYFIT

Ref.	Cod.		Emb.	€	
I-61	660436.E	Válvula lavabo-bidet 1" 1/2 x 70	BOLSA	4,65	65

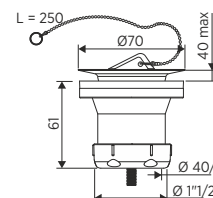

Ref.	Cod.		Emb.	€	
I-61	660436	Válvula lavabo-bidet 1" 1/2 x 70	BOLSA	3,50	65
I-273	660521		BLISTER	4,35	85



Ref.	Cod.		Emb.	€	
I-275	660523	Válvula lavabo-bidet 1" 1/4 x 70 con tapón metálico	BOLSA	3,95	75
I-276	660524		BLISTER	4,60	85

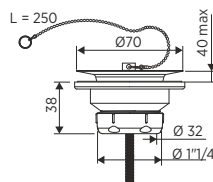

Ref.	Cod.		Emb.	€	
I-277	660525	Válvula lavabo-bidet 1" 1/2 x 70 con tapón metálico	BOLSA	4,00	75
I-278	660526		BLISTER	4,65	85

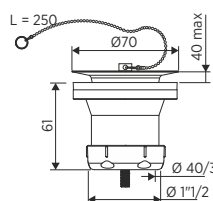



FREGADERO

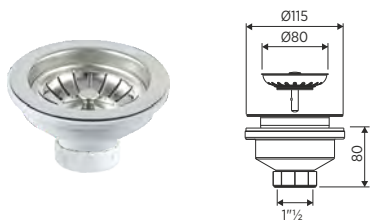

Ref.	Cod.		€	
I-86	661164	Válvula cesta ACERO INOX para fregadero 1"1/2 x115 con tornillo para instalación tanto de fregaderos inoxidables como sintéticos	12,45	65

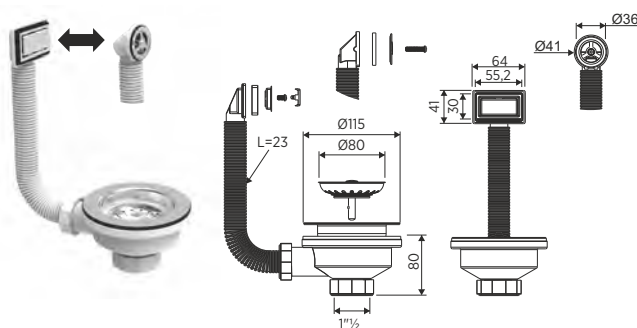

Ref.	Cod.		€	
I-87	661165	Válvula cesta ACERO INOX para fregadero con dos rebosaderos flexibles rectangular/redondo 1"1/2 x 115 con tornillo para instalación tanto de fregaderos inoxidables como sintéticos	16,75	30

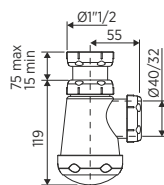

Ref.	Cod.		€	
I-20	660410	Sifón botella extensible, salida horizontal Ø40 mm, con reductora Ø32 mm, y racor 1"1/2 para fregadero	3,55	60

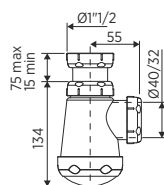

Ref.	Cod.		€	
I-20	660410.E	Sifón botella extensible, salida horizontal Ø40 mm, con reductora Ø32 mm, y racor 1"1/2 para fregadero	4,25	60

FREGADERO

SIFONES Y VÁLVULAS

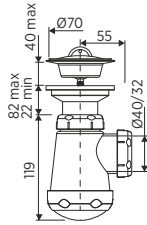

Ref.	Cod.		€	
I-21	660411	Sifón botella extensible, salida horizontal Ø40 mm, con reductora Ø32 mm, válvula fregadero 1"1/2 x 70	4,95	45

EASYFIT

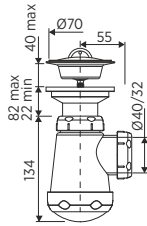

Ref.	Cod.		€	
I-21	660411.E	Sifón botella extensible, salida horizontal Ø40 mm, con reductora Ø32 mm, válvula fregadero 1"1/2 x 70	5,95	45

EASYFIT

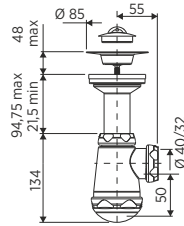

Ref.	Cod.		€	
I-22	660412	Sifón botella extensible, salida horizontal Ø40 mm, con reductora Ø32 mm, válvula fregadero 1"1/2 x 85	5,95	45

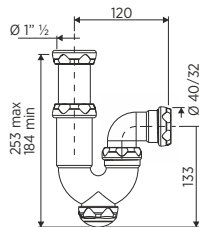

Ref.	Cod.		€	
I-23	660413	Sifón curvo extensible, salida horizontal Ø40 mm, con reductora Ø32 mm, racor 1"1/2 para fregadero	4,70	40

EASYFIT

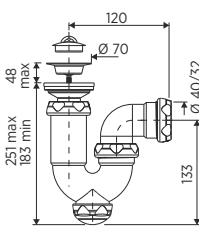



Ref.	Cod.		€	
I-24	660414	Sifón curvo extensible, salida horizontal Ø40 mm con reductora Ø32 mm, válvula fregadero 1"1/2 x 70	6,10	35

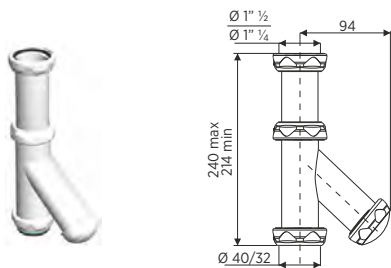



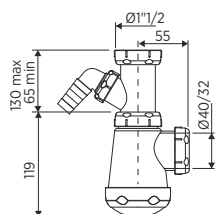

Ref.	Cod.		€	
I-29	660419	Sifón "Y" extensible, salida Ø40 mm, con reductora Ø32 mm, y racor 1" 1/2 para fregadero	4,40	50

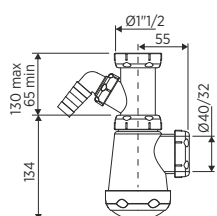

Ref.	Cod.		€	
I-94	660462	Sifón "Y" extensible, salida Ø40 mm, con reductora Ø32 mm, y racor 1" 1/4 para fregadero	4,40	50
I-30	660420	Sifón botella extensible, salida horizontal Ø40 mm, con reductora Ø32 mm, racor 1"1/2 con una toma auxiliar para fregadero	4,25	50



Ref.	Cod.		€	
I-30	660420.E	Sifón botella extensible, salida horizontal Ø40 mm, con reductora Ø32 mm, racor 1"1/2 con una toma auxiliar para fregadero	4,95	45

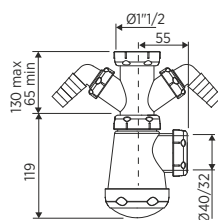

Ref.	Cod.		€	
I-31	660421	Sifón botella extensible, salida horizontal Ø40 mm, con reductora Ø32 mm, racor 1" 1/2 con dos tomas auxiliares para fregadero	4,55	40

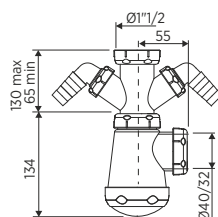

Ref.	Cod.		€	
I-31	660421.E	Sifón botella extensible, salida horizontal Ø40 mm, con reductora Ø32 mm, racor 1" 1/2 con dos tomas auxiliares para fregadero	5,15	40

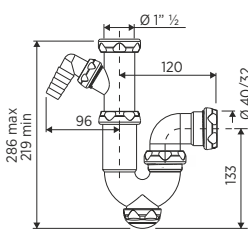

Ref.	Cod.		€	
I-32	660422	Sifón curvo extensible, salida horizontal Ø40 mm, con reductora Ø32 mm, racor 1" 1/2 con una toma auxiliar para fregadero	5,45	35

FREGADERO

SIFONES Y VÁLVULAS

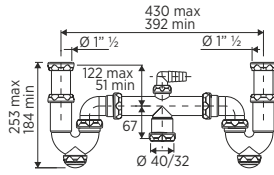

Ref.	Cod.		€	
------	------	--	---	--

I-40	660425	Sifón curvo doble, extensible, salida orientable, con racores 1"1/2 y toma auxiliar para fregadero	9,80	15
------	---------------	--	------	----

EASYFIT

Ref.	Cod.		€	
------	------	--	---	--

I-41	660426	Sifón curvo doble, extensible, salida orientable con válvulas 1" 1/2 x 70 y toma auxiliar para fregadero	12,35	14
------	---------------	--	-------	----

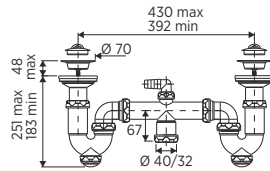

Ref.	Cod.		€	
------	------	--	---	--

I-42	660427	Sifón curvo, extensible, salida horizontal Ø40 mm, con reductora Ø32 mm, con doble racor extensible 1"1/2 y una toma auxiliar para fregadero	10,55	14
------	---------------	--	-------	----

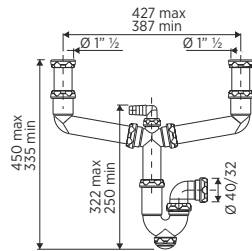

EASYFIT

Ref.	Cod.		€	
------	------	--	---	--

I-43	660428	Sifón curvo, extensible, salida horizontal Ø40 mm, con reductora Ø32 mm, con doble válvula fregadero 1" 1/2 x 70 y una toma auxiliar	13,25	12
------	---------------	--	-------	----

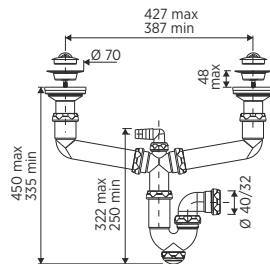

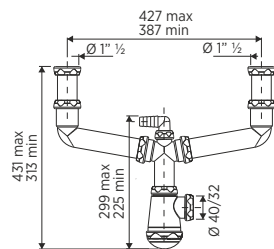

Ref.	Cod.		€	
I-44	660429	Sifón botella extensible, salida horizontal Ø40 mm, con reductora Ø32 mm, con doble racor extensible 1" 1/2 y una toma auxiliar para fregadero	10,35	15

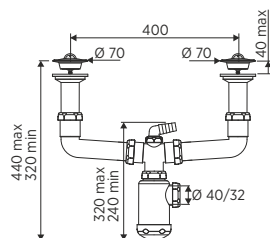

Ref.	Cod.		€	
I-45	660430	Sifón botella, extensible, salida horizontal Ø40 mm, con reductora Ø32 mm, con doble válvula fregadero 1"1/2x70 y una toma auxiliar	11,45	12

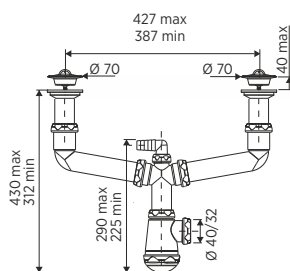

EASYFIT

Ref.	Cod.		€	
I-45	660430.E	Sifón botella, extensible, salida horizontal Ø40 mm, con reductora Ø32 mm, con doble válvula fregadero 1"1/2x70 y una toma auxiliar	12,70	12

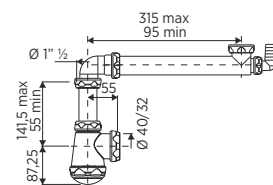

Ref.	Cod.		€	
I-50	661181	Sifón botella extensible salida horizontal Ø40 mm, con reductora Ø32 mm, con "T" telescópica ahorro espacio y toma auxiliar (un seno) para fregadero	7,75	22

EASYFIT

Ref.	Cod.		€	
I-65	660440	Válvula con rebosadero flexible rectangular sin chapa, fregadero 1"1/2 x 70 para fregadero	8,20	40

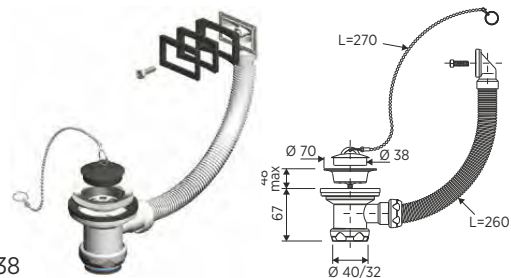

FREGADERO

SIFONES Y VÁLVULAS

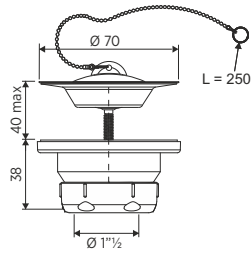
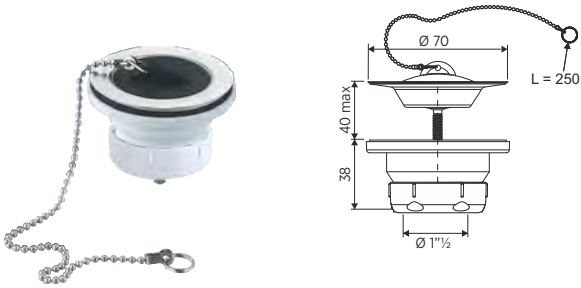

Ref.	Cod.		€	
I-62	660437	Válvula fregadero 1"1/2x 70	3,25	65

EASYFIT

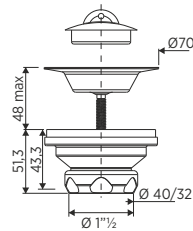

Ref.	Cod.		€	
I-62	660437.E	Válvula fregadero 1"1/2x 70	3,90	65

EASYFIT

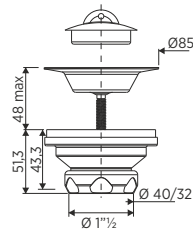

Ref.	Cod.		€	
I-63	660438	Válvula fregadero 1"1/2 x 85	4,05	50

EASYFIT

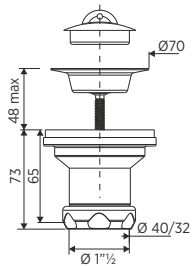

Ref.	Cod.		€	
I-64	660439	Válvula alta fregadero 1"1/2 x 70	4,15	50





DUCHA

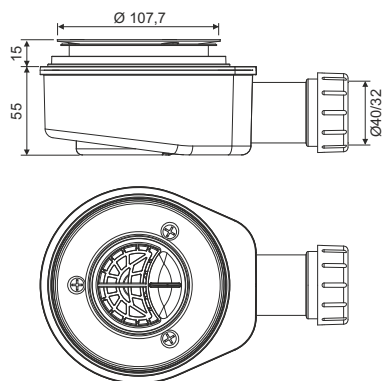

Ref.	Cod.		Emb.	€	📦
I-264	660512	Válvula sifónica extraplana plato de ducha SIN EMBELLECEDOR	BOLSA	16,80	32
I-265	660513		CAJA	18,65	17

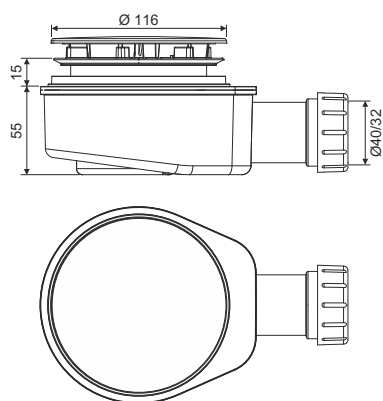

Ref.	Cod.		Emb.	€	📦
I-266	660514	Válvula sifónica extraplana plato de ducha CON EMBELLECEDOR CROMADO	BOLSA	18,65	25
I-267	660515		CAJA	20,30	15

DUCHA

SIFONES Y VÁLVULAS

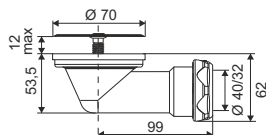

Ref.	Cod.		€	
I-100	660465	Válvula para plato ducha con orificio Ø50 mm, salida horizontal Ø40 mm con reductora Ø32 mm, rejilla inox. Ø70 mm (bote sifónico)	4,05	50

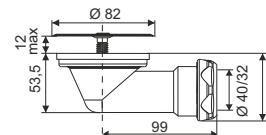

Ref.	Cod.		€	
I-101	660466	Válvula para plato ducha con orificio Ø60 mm, salida horizontal Ø40 mm con reductora Ø32 mm, con rejilla inox. Ø82 mm (bote sifónico)	4,10	75

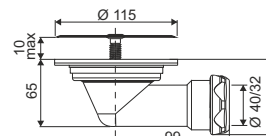

Ref.	Cod.		€	
I-108	661152	Válvula para plato ducha con orificio Ø90 mm, salida horizontal Ø40 mm con reductora Ø32 mm, con rejilla inox. Ø115 mm (bote sifónico)	5,60	55

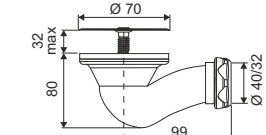

Ref.	Cod.		€	
I-103	660468	Válvula sifónica para plato ducha con orificio Ø50 mm, salida horizontal Ø40 mm con reductora Ø32 mm, rejilla inox. Ø70 mm	4,60	75

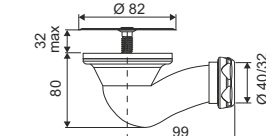

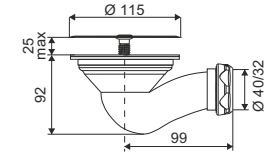

Ref.	Cod.		€	
I-104	660469	Válvula sifónica para plato ducha con orificio Ø60 mm, salida horizontal Ø40 mm con reductora Ø32 mm, rejilla inox. Ø82 mm	4,95	75



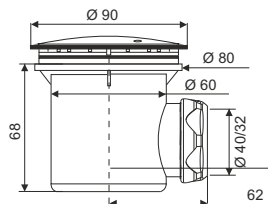

Ref.	Cod.		€	
I-107	661151	Válvula sifónica para plato ducha con orificio Ø90 mm, salida horizontal Ø40 mm con reductora Ø32 mm, con rejilla inox. Ø115 mm	6,00	50



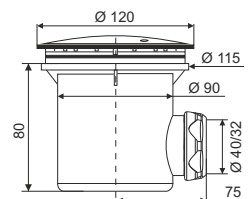

Ref.	Cod.		€	
I-105	660470	Válvula sifónica para plato ducha con orificio Ø60 mm, salida horizontal Ø40 mm con reductora Ø32 mm, CON EMBELLECEDOR ABS CROMADO REGISTRABLE	6,20	60



Ref.	Cod.		Emb.	€	
I-256	660507	Válvula sifónica para plato ducha con orificio Ø90 mm, salida horizontal Ø40 mm con reductora Ø32 mm, CON EMBELLECEDOR ABS CROMADO REGISTRABLE	BOLSA	10,40	30
I-106	660471		CAJA	11,45	24

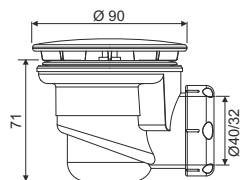

Ref.	Cod.		€	
I-112	661158	Válvula sifónica para plato ducha con orificio Ø60 mm, salida horizontal Ø40 mm con reductora Ø32 mm, CON EMBELLECEDOR ABS CROMADO REGISTRABLE	6,50	75

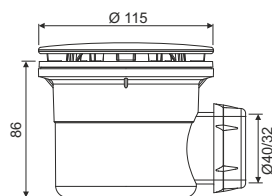

Ref.	Cod.		€	
I-113	661159	Válvula sifónica para plato ducha con orificio Ø90 mm, salida horizontal Ø40 mm con reductora Ø32 mm, CON EMBELLECEDOR ABS CROMADO REGISTRABLE	10,90	36

DUCHA

SIFONES Y VÁLVULAS

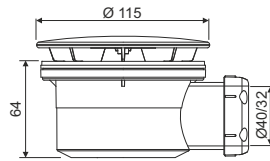

Ref.	Cod.		€	
I-109	661155	Válvula sifónica para plato ducha con orificio Ø90 mm, salida horizontal Ø40 mm, con reductora Ø32 mm, CON EMBELLECEDOR ABS CROMADO REGISTRABLE	10,90	45

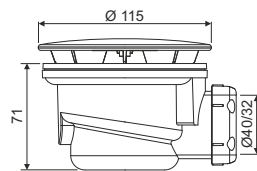

Ref.	Cod.		€	
I-111	661157	Válvula sifónica para plato ducha con orificio Ø90 mm, salida horizontal Ø40 mm, con reductora Ø32 mm, CON EMBELLECEDOR ABS CROMADO REGISTRABLE	10,90	45

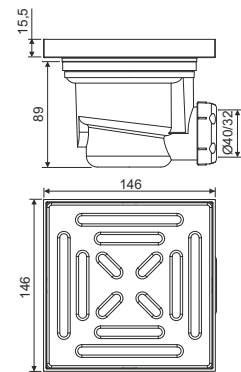

Ref.	Cod.		€	
I-110	661156	Sumidero para plato ducha de obra, con válvula sifónica salida horizontal Ø40 mm con reductora Ø32 mm CON TAPA ACERO INOX	13,30	30

INOX

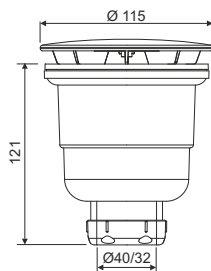

Ref.	Cod.		€	
I-82	661154	Válvula sifónica para plato ducha con orificio Ø90 mm, salida vertical Ø 40mm, con reductora Ø32 mm, CON EMBELLECEDOR ABS CROMADO REGISTRABLE	11,75	40



SIFONES
BAÑERA



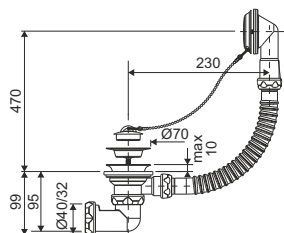

Ref.	Cod.		€	
I-80	660445	Válvula bañera salida horizontal, orientable con tuerca Ø40 mm, con rebosadero extensible	9,20	30

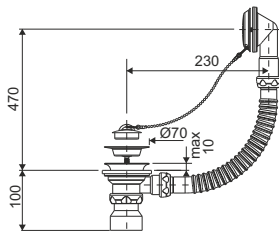

Ref.	Cod.		€	
I-81	660446	Válvula bañera salida vertical PVC encolar Ø40 mm, con rebosadero extensible	8,70	35

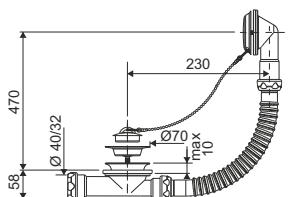

Ref.	Cod.		€	
I-84	660449	Válvula bañera salida horizontal extraplana, orientable con tuerca Ø40 mm	8,75	40

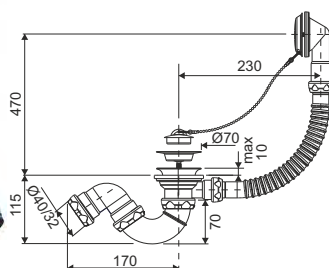

Ref.	Cod.		€	
I-90	660455	Válvula sifónica bañera salida orientable con tuerca Ø40 mm, con rebosadero extensible (S)	9,80	30

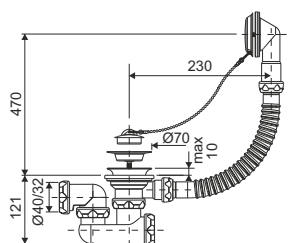

Ref.	Cod.		€	
I-91	660456	Válvula sifónica bañera autolimpiante, salida horizontal con tuerca Ø40 mm, con rebosadero extensible	9,90	25

SIFONES URINARIOS



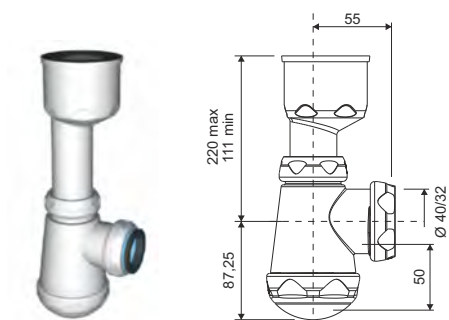

Ref.	Cod.		€	
I-250	661161	Sifón botella extensible, salida horizontal Ø40 mm, con reductora Ø32 mm, acople a urinario	13,85	35

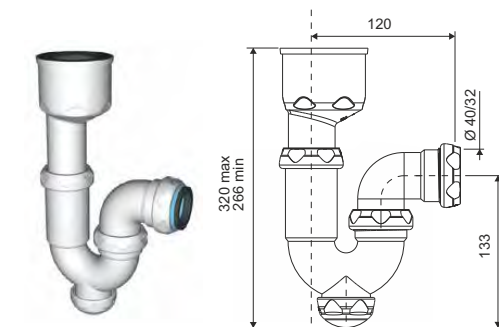

Ref.	Cod.		€	
I-251	661162	Sifón curvo extensible, salida horizontal Ø40 mm, con reductora Ø32 mm, acople a urinario	13,85	30

TUBOS FLEXIBLES

Tª trabajo: -5% +60°C

TODOS LOS MODELOS INCLUYEN JUNTA PLANA Y EMBELLECEDOR

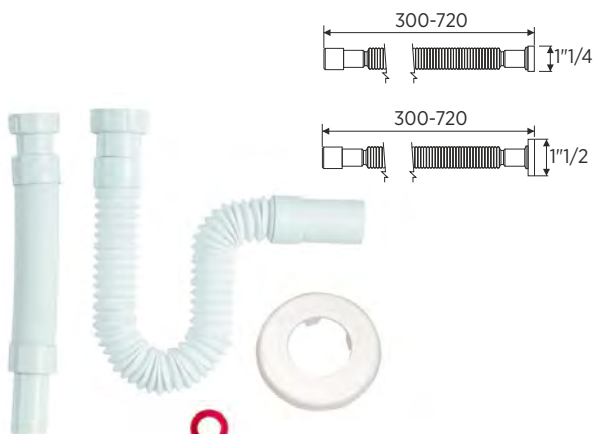

Mat.	Ref.	Cod.		€	
PP	I-164	30603	Tubo flexible BLANCO lavabo-bidet 1"1/4 Ø32-40 Lmax = 72 cm, Lmin = 30 cm	2,95	50

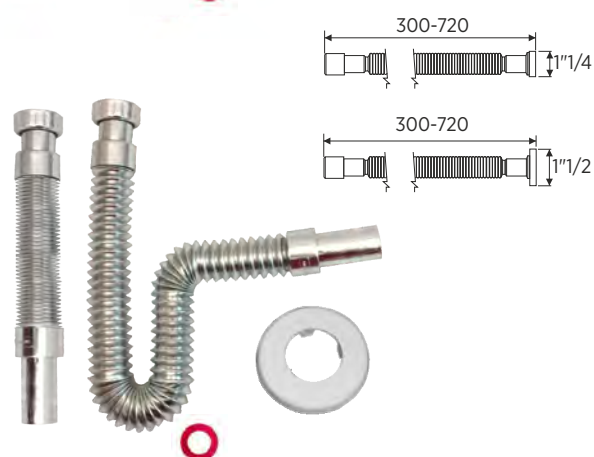

Mat.	Ref.	Cod.		€	
PP	I-165	30604	Tubo flexible BLANCO fregadero 1"1/2 Ø40-50 Lmax = 72 cm, Lmin = 30 cm	3,00	50



Mat.	Ref.	Cod.		€	
PP	I-166	30605	Tubo flexible CROMOMADO lavabo-bidet 1"1/4 Ø32-40 Lmax = 72 cm, Lmin = 30 cm	6,85	50

Mat.	Ref.	Cod.		€	
PP	I-167	30606	Tubo flexible CROMOMADO fregadero 1"1/2 Ø40-50 Lmax = 72 cm, Lmin = 30 cm	6,85	50



Mat.	Ref.	Cod.		€	
PP	I-168	30610	Tubo flexible BLANCO lavabo-bidet 1"1/4 Ø32-40 , con tuerca LATÓN cromada. Lmax = 72 cm, Lmin = 30 cm	3,30	50

Mat.	Ref.	Cod.		€	
PP	I-169	30609	Tubo flexible BLANCO fregadero 1"1/2 Ø40-50, con tuerca LATÓN cromada. Lmax = 72 cm, Lmin = 30 cm	3,35	50

TUBOS FLEXIBLES EQUIPAMIENTO WC

Tª trabajo: -5% +60°C

TODOS LOS MODELOS INCLUYEN JUNTA PLANA Y EMBELLECEDOR

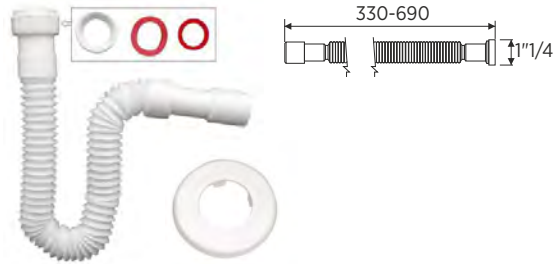

Mat.	Ref.	Cod.		€	
PP	I-172	30634	Tubo flexible BLANCO 1"1/2 Ø32-40 con reductor 1"1/4 Lmax = 69cm, Lmin = 33 cm	4,60	50

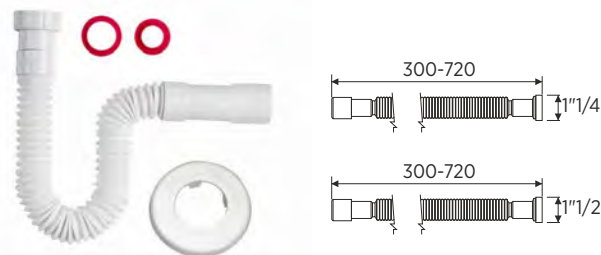
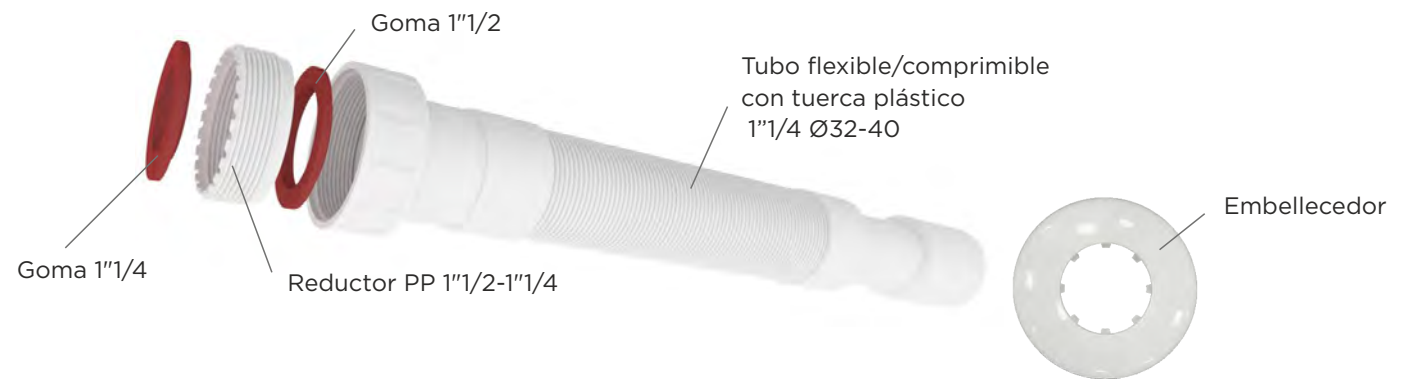

Mat.	Ref.	Cod.		€	
ABS		30637	Tubo flexible BLANCO 1"1/4 Ø32-40. ENCOLABLE.	4,20	50
ABS		30638	Tubo flexible BLANCO 1"1/2 Ø40-50. ENCOLABLE.	4,25	50

**PRODUCTO
NUEVO**



PRODUCTO
NUEVO

Mat.	Ref.	Cod.		€	
PP		30641	Florón embellecedor BLANCO Ø 32	0,70	50
PP		30642	Florón embellecedor BLANCO Ø 40	0,70	50



PRODUCTO
NUEVO

Mat.	Ref.	Cod.		€	
PP		30643	Florón embellecedor CROMO Ø 32	1,45	50
PP		30644	Florón embellecedor CROMO Ø 40	1,45	50



PRODUCTO
NUEVO

Mat.	Ref.	Cod.		€	
		30645	Junta para flexible 1" 1/4	0,45	50
		30646	Junta para flexible 1" 1/2	0,45	50

PIEZAS DE RECAMBIO



PIEZAS DE RECAMBIO SIFONES Y VÁLVULAS

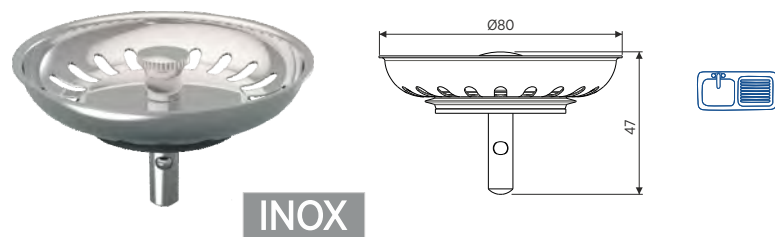

Cod.		€	Embalaje	
660502	Rejilla filtro INOX para válvula cesta Ø80 con pasador metálico	4,65	Granel	10/bolsa



Cod.		€	Embalaje	
660503	Rejilla filtro INOX para válvula cesta Ø80 con pasador plástico	3,35	Granel	10/bolsa

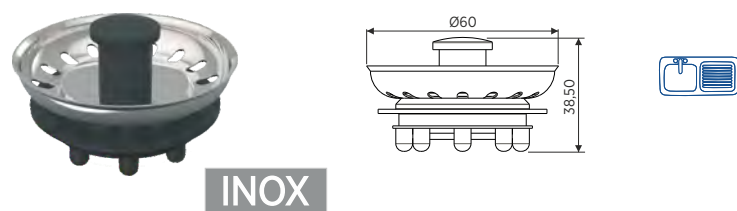

Cod.		€	Embalaje	
660504	Rejilla filtro INOX para válvula cesta Ø60 tipo araña	3,40	Granel	10/bolsa

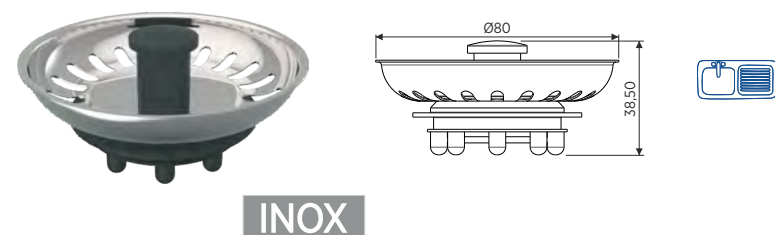

Cod.		€	Embalaje	
660505	Rejilla filtro INOX para válvula cesta Ø80 tipo araña	3,40	Granel	10/bolsa

PIEZAS DE RECAMBIO

SIFONES Y VÁLVULAS

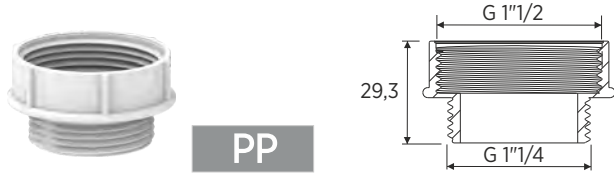

PP

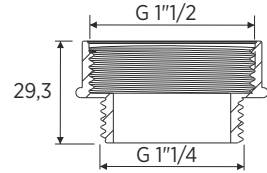

PP

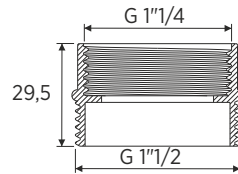

PP

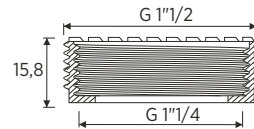

PVC

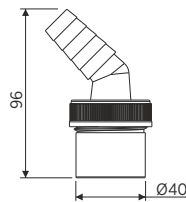

PVC

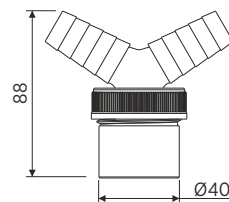

ABS

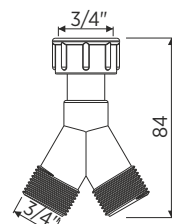

PVC

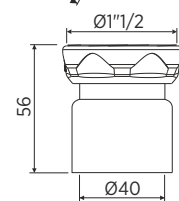

Cod.		€	Embalaje	
30614	Adaptador convertidor PP roscas macho 1"1/4 - hembra 1"1/2	0,95	Granel	10/bolsa

Cod.		€	Embalaje	
30615	Adaptador convertidor PP roscas macho 1"1/2 - hembra 1"1/4	0,95	Granel	10/bolsa

Cod.		€	Embalaje	
30628	Reductor PP 1"1/2 a 1"1/4	0,95	Granel	10/bolsa

Ref.	Cod.		€	Embalaje	
I-156	660500	Conexión PVC Ø40 (encolar) con una toma para electrodomésticos	2,20	Bolsa	10/bolsa

Ref.	Cod.		€	Embalaje	
I-157	660501	Conexión PVC Ø40 (encolar) con toma doble para electrodomésticos	2,75	Bolsa	10/bolsa

Ref.	Cod.		€	Embalaje	
I-268	660516	Racor doble lavadora lavavajillas 3/4"	2,80	Bolsa	10/bolsa

Ref.	Cod.		€	Embalaje	
I-140	660484	Enlace mixto PVC 1"1/2x40 (encolar)	1,65	Bolsa	10/bolsa



PIEZAS DE RECAMBIO SIFONES Y VÁLVULAS

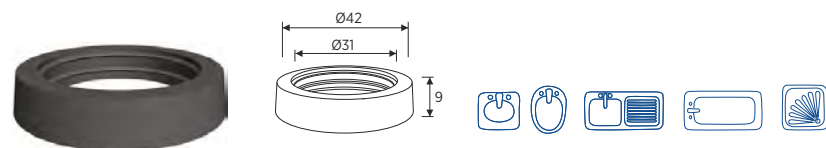

Cod.		€	Embalaje	
660315	Junta cónica reductora Ø32	0,45	Granel	25/bolsa

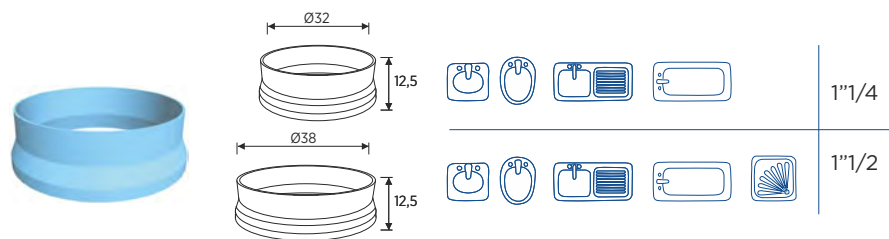

Cod.		€	Embalaje	
660332	Junta cónica (PE) SOFT	0,50	Granel	50/bolsa
660314		0,50	Granel	50/bolsa

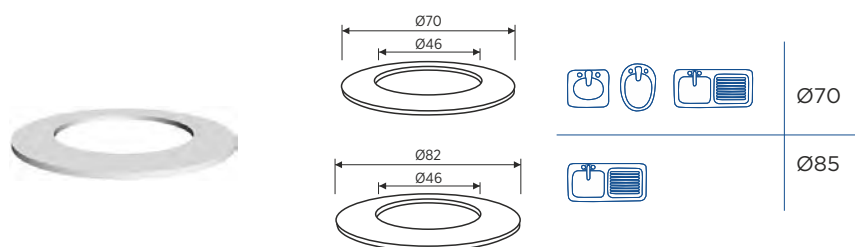

Cod.		€	Embalaje	
660334	Junta plana superior válvula	0,45	Granel	50/bolsa
660339		0,60	Granel	50/bolsa

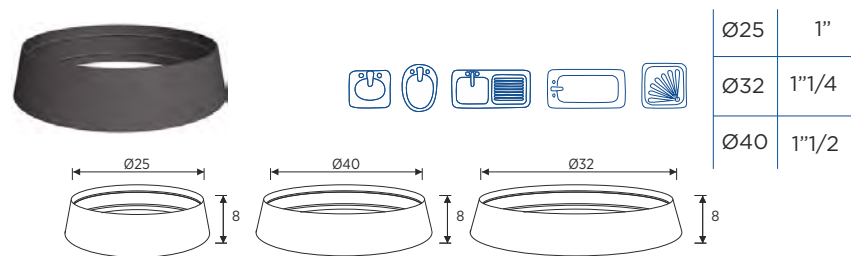

Cod.		€	Embalaje	
660311	Junta cónica	0,40	Granel	50/bolsa
660310		0,40	Granel	50/bolsa
660320		0,40	Granel	50/bolsa

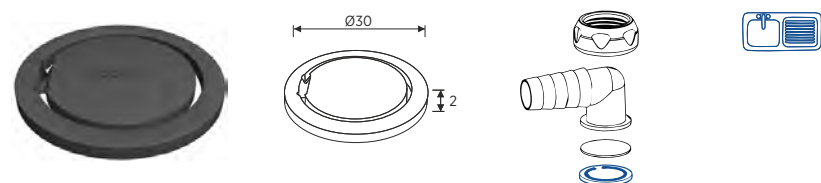

Cod.		€	Embalaje	
660344	Junta retención toma auxiliar	0,40	Granel	50/bolsa

PIEZAS DE RECAMBIO

SIFONES Y VÁLVULAS

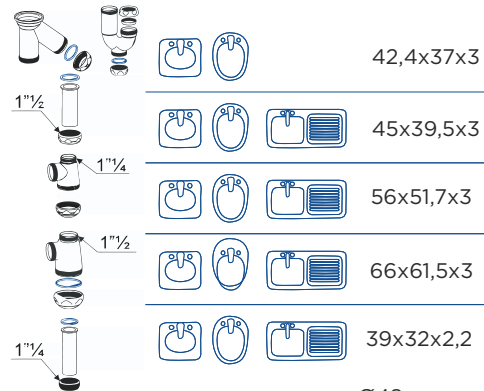
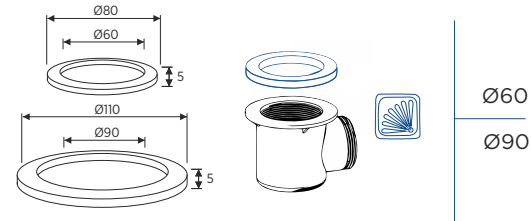
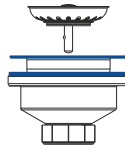
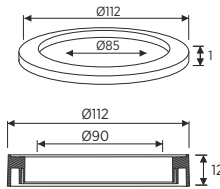
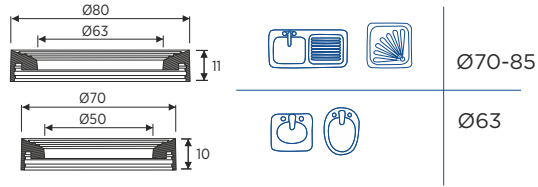

PRODUCTO NUEVO

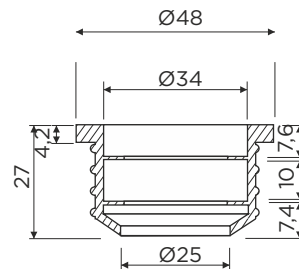

Cod.		€	Embalaje
660340	Junta inferior válvula EASYFIT	0,65	Granel 25/bolsa
660305	Junta inferior válvula EASYFIT	0,70	Granel 25/bolsa

Cod.		€	Embalaje
660336	Junta blanca válvula fregadero ref. 661164, 661165	0,80	Granel 25/bolsa
660335	Junta válvula fregadero ref. 661164, 661165	1,20	Granel 25/bolsa

Cod.		€	Embalaje
660396	Junta plana válvula sifónica ducha	0,90	Granel 10/bolsa
660380		1,05	Granel 10/bolsa

Cod.		€	Embalaje
660325	Junta plana	0,40	Granel 25/bolsa
660331		0,40	Granel 25/bolsa
660312		0,40	Granel 25/bolsa
660322		0,40	Granel 25/bolsa
660318		0,40	Granel 25/bolsa

Cod.		€	Embalaje
30635	Goma unión tubo 40 x 26/32	1,10	Granel 25/bolsa



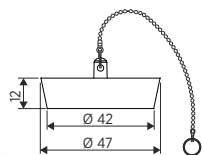

L=250mm

Cod.	€	Embalaje	
660491	2,20	Bolsa	10/bolsa

Conjunto tapón PVC con cubierta INOX y cadenilla 250 mm

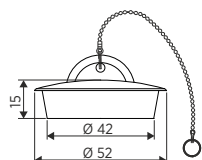

L=380mm

Ref.	Cod.	€	Embalaje	
I-145	660489	2,00	Bolsa	25/bolsa
I-146	660490	1,75	Bolsa	25/bolsa

Tapón válvulas con cadena y anillas



L=250mm



L=380mm

Ref.	Cod.	€	Embalaje	
I-162	660271	1,35	Granel	25/bolsa
I-163	660301	1,15	Granel	25/bolsa

Cadena con dos anillas



L=250mm

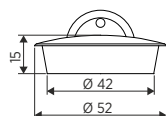

Cod.	€	Embalaje	
660337	0,70	Granel	25/bolsa

Tapón válvula

PIEZAS DE RECAMBIO

SIFONES Y VÁLVULAS



				Ø70
				Ø85



	Ø70
	Ø85
	Ø115



		M12x36
--	--	--------



		M6x35		
		M6x45		
		M6x55		
				M6x65



		1"			
				1"1/4	
					1"1/2



			1"1/2
			1"1/4
			Ø50

Cod.		€	Embalaje	
660333	Rejilla inoxidable	1,00	Granel	10/bolsa
660338		1,20	Granel	10/bolsa

Cod.		€	Embalaje	
660370	Rejilla inoxidable ducha	1,10	Granel	10/bolsa
660363		1,15	Granel	10/bolsa
660373		1,60	Granel	10/bolsa

Cod.		€	Embalaje	
30613	Tornillo largo válvula cesta para fregaderos sintéticos	1,70	Granel	10/bolsa

Cod.		€	Embalaje	
660364	Tornillo inoxidable	0,80	Granel	10/bolsa
660381		0,80	Granel	10/bolsa
660365		0,80	Granel	10/bolsa
660306		0,90	Granel	10/bolsa

Cod.		€	Embalaje	
660346	Tuerca	0,65	Granel	10/bolsa
660309		0,70	Granel	10/bolsa
660316		0,75	Granel	10/bolsa

Cod.		€	Embalaje	
660323	Tapón registro sifones	0,75	Granel	10/bolsa
660313		0,80	Granel	10/bolsa
660326		1,10	Granel	10/bolsa



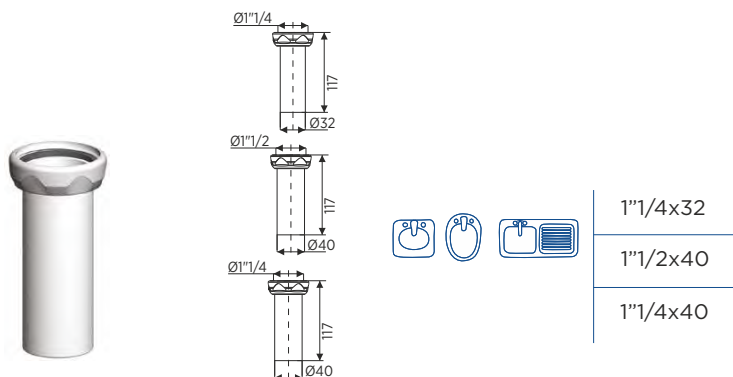

Ref.	Cod.		€	Embalaje	
I-133	660477	Racor con valona y tuerca loca	1,80	Bolsa	1/bolsa
I-132	660476		1,80	Bolsa	1/bolsa
I-260	660508		1,80	Bolsa	1/bolsa

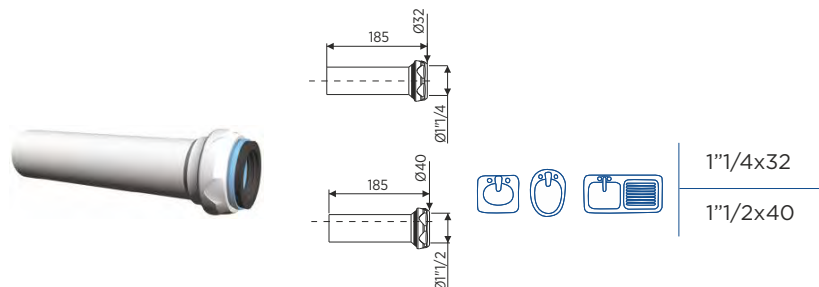

Ref.	Cod.		€	Embalaje	
I-160	660463	Alargadera con una entrada roscada	2,00	Bolsa	1/bolsa
I-142	660486		2,05	Bolsa	1/bolsa

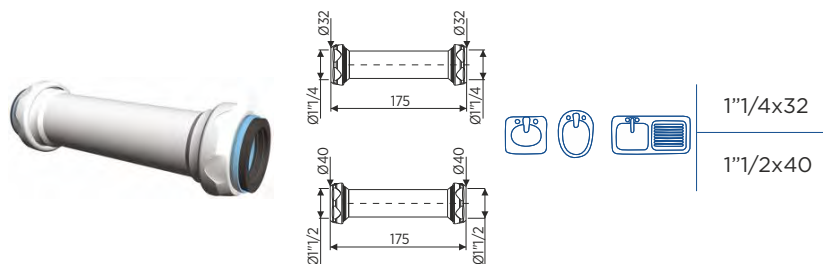

Ref.	Cod.		€	Embalaje	
I-139	660483	Alargadera dos entradas roscadas	2,10	Bolsa	1/bolsa
I-141	660485		2,20	Bolsa	1/bolsa

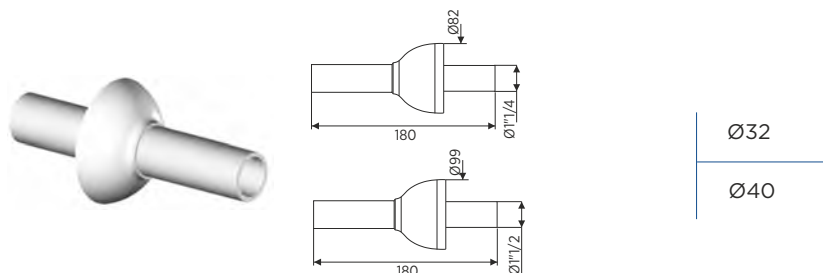

Ref.	Cod.		€	Embalaje	
I-154	660498	Alargadera acoplamiento a pared con plafón embellecedor	2,00	Bolsa	1/bolsa
I-155	660499		2,15	Bolsa	1/bolsa

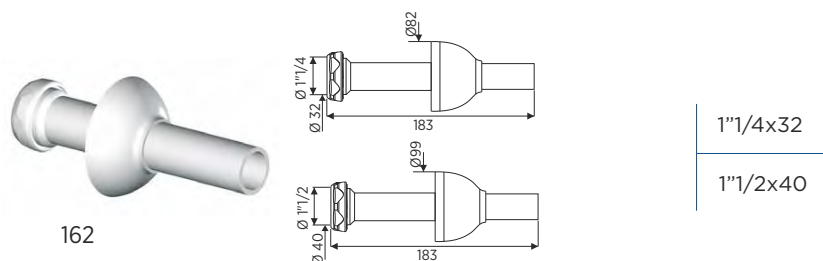

Ref.	Cod.		€	Embalaje	
I-152	660496	Alargadera acoplamiento a pared con plafón embellecedor y con una entrada roscada	2,25	Bolsa	1/bolsa
I-153	660497		2,35	Bolsa	1/bolsa

PIEZAS DE RECAMBIO

SIFONES Y VÁLVULAS

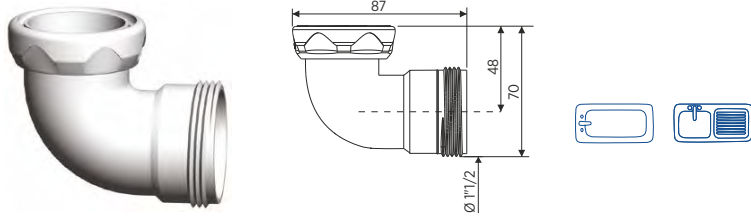

Ref.	Cod.		€	Embalaje	
I-136	660480	Codo rosca una entrada, con valona y tuerca loca	1,50	Bolsa	1/Bolsa

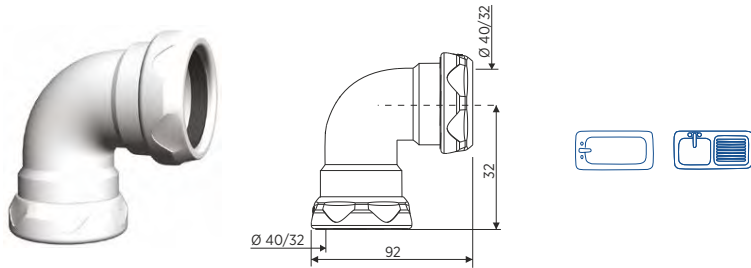

Ref.	Cod.		€	Embalaje	
I-137	660481	Codo para tubos dos entradas roscadas 1" 1/2, con reductora Ø32	1,85	Bolsa	1/Bolsa

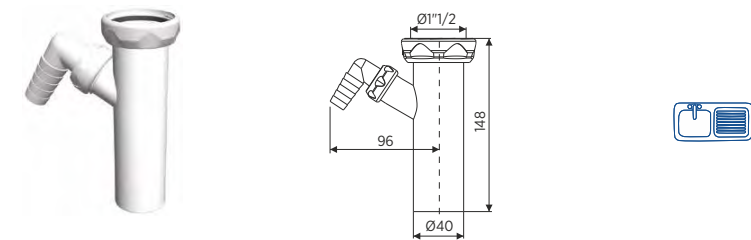

Ref.	Cod.		€	Embalaje	
I-130	660474	Racor con valona y tuerca loca 1" 1/2, con una toma auxiliar	2,40	Bolsa	1/Bolsa

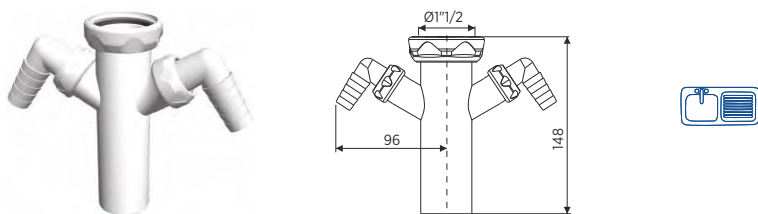

Ref.	Cod.		€	Embalaje	
I-131	660475	Racor con valona y tuerca loca 1" 1/2, con dos tomas auxiliares	2,60	Bolsa	1/Bolsa

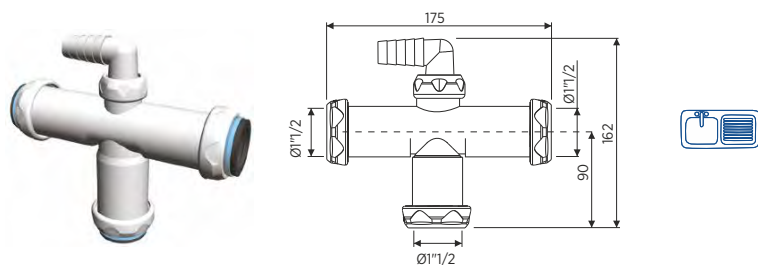

Ref.	Cod.		€	Embalaje	
I-138	660482	"T" con entradas roscadas y toma auxiliar roscada	3,35	Bolsa	1/Bolsa



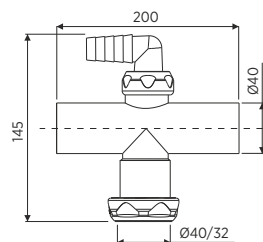

Ref.	Cod.		€	Embalaje	
I-151	660495	"T" lisa con toma auxiliar y tuerca 1" 1/2	3,85	Bolsa	1/Bolsa

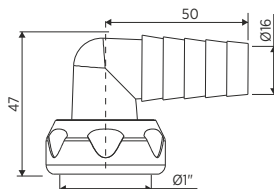

Ref.	Cod.		€	Embalaje	
I-149	660493	Codo toma auxiliar con tuerca	1,30	Bolsa	1/Bolsa

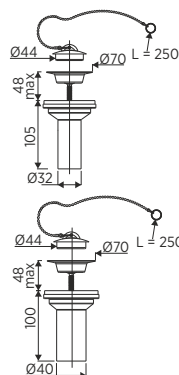

Ø32x70

Ø40x70

Ref.	Cod.		€	Embalaje	
I-143	660487	Válvula extensible lavabo-bidet	4,00	Bolsa	1/Bolsa
I-144	660488		4,25	Bolsa	1/Bolsa

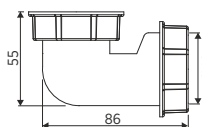

Ref.	Cod.		€	Embalaje	
I-150	660494	Codo extraplano horizontal 1"1/2x40	1,60	Bolsa	1/Bolsa

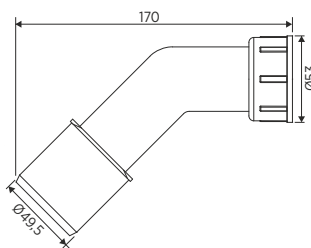

Ref.	Cod.		€	Embalaje	
I-271	660519	Tubo conexión acodado orientable 1"1/2x40 encolable	1,60	Bolsa	1/Bolsa

PRESENTACIÓN DE PRODUCTO



Caja individual

Embalaje disponible para
 varios de nuestros productos



Blister

Embalaje disponible para
 varios de nuestros productos



Bolsa

Embalaje disponible para
 varios de nuestros productos

PRESENTACIÓN DE PRODUCTO
EXPOSITORES

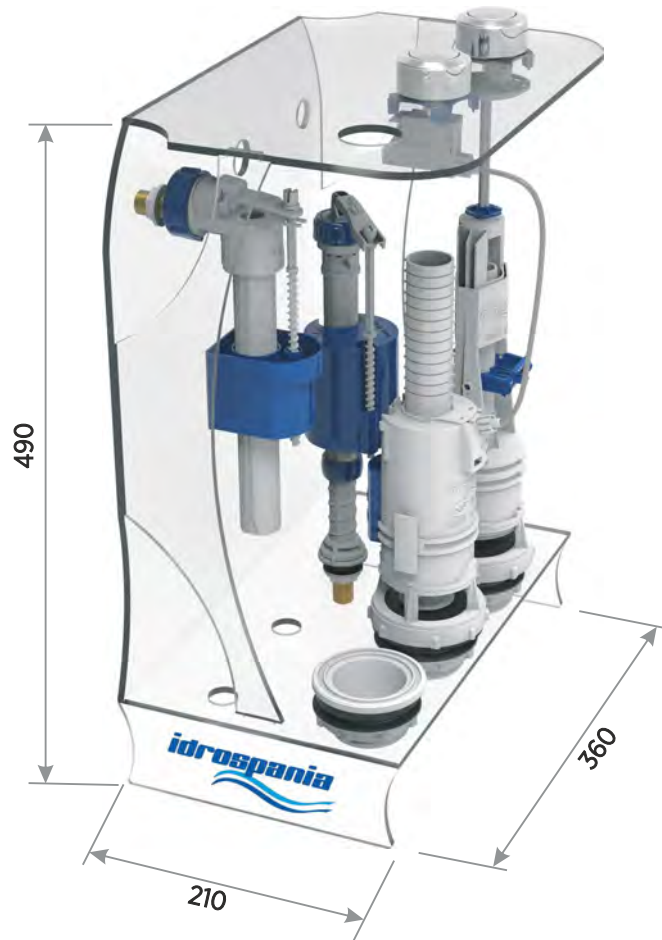

Expositor de metacrilato descargadores y grifos



Expositor de conjuntos higiénicos



Expositor A4 con cajetín para folletos



Diseño y dimensiones orientativas

Expositor cisternas

Consultar condiciones

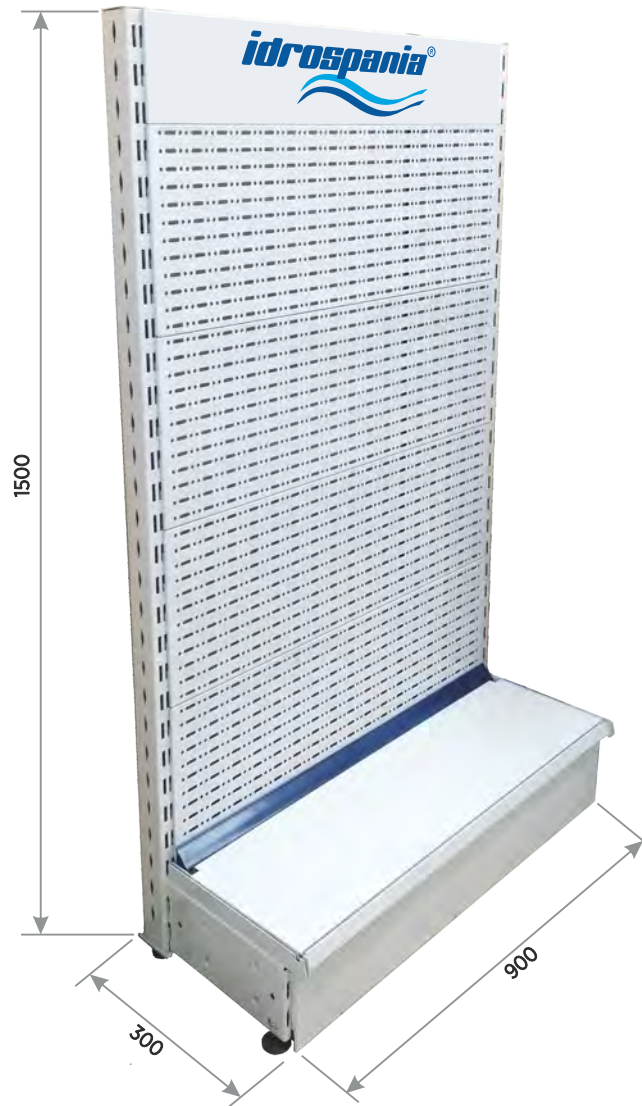

Expositor metálico

Consultar condiciones



BOX Expositor

CONDICIONES GENERALES

PRECIOS

Los precios reflejados en nuestra tarifa son los recomendados de venta al público y expresados en euros.

Precios válidos salvo error tipográfico.

Este catálogo/tarifa anula a los anteriores.

Idrosponia se reserva el derecho de poder cambiar su política de precios en cualquier momento con su correspondiente preaviso.

IMPUESTOS

Serán aplicados en factura, sobre los precios indicados en nuestra tarifa, los impuestos pertinentes de acuerdo con la ley vigente.

PEDIDOS

Los pedidos deberán ser remitidos por escrito, ello supone la aceptación por parte del cliente de todas las condiciones generales de venta.

ANULACIONES DE PEDIDOS

Las anulaciones al igual que los pedidos deberán ser remitidas por escrito, no admitiendo las mismas cuando la expedición del material haya sido realizada.

PORTES PAGADOS

Para los pedidos por importe superior a **350 euros** (base imponible) para península, **500 euros** para Baleares y **1.000 euros** para las Islas Canarias y Andorra, el transporte será por cuenta de IDROSPANIA.

EXPEDICIONES

La mercancía viaja por cuenta y riesgo del comprador.

EMBALAJES

El material se servirá en la forma de embalaje establecida por IDROSPANIA en cada una de la forma reflejada en nuestros códigos del catalogo/tarifa vigente.

PLAZOS DE ENTREGA

Los plazos de entrega establecidos se consideran a modo orientativo, sin aceptar de modo alguno, reclamaciones por algún posible retraso del envío.

GARANTÍA

El periodo de garantía de nuestros productos es de 3 años, desde la fecha de compra del comprador, siempre y cuando el material haya sido mantenido e instalado de forma correcta con la normativa vigente.

Queda limitada la reposición de material que nuestro departamento de control de calidad no considere como defectuosas.

Idrosponia no se hace responsable de los daños que directa o indirectamente pudieran dar lugar los defectos en sus productos, si los mismos han sido manipulados o si se utilizan siliconas o cualquier otro tipo de sellador industrial que puedan dañar a nuestros productos.

CONDICIONES DE PAGO

El pago será efectuado en las condiciones pactadas con el comprador y en los plazos estipulados con el mismo.

DEVOLUCIONES DE MATERIAL POR ACUERDOS COMERCIALES

Las devoluciones de material, deberán realizarse a través de nuestros agentes comerciales bajo la autorización y condiciones pactadas. No se admiten devoluciones de material de producto descatalogado sea cual fuere su estado.

RESERVA DE MODIFICACIÓN

IDROSPANIA se reserva el derecho de poder cambiar sin previo aviso, el diseño de todos sus productos.

COMPETENCIA JURÍDICA

Ambas partes se someten a la competencia de los Tribunales y Juzgados de Castellón.

ÍNDICE POR CÓDIGOS

CÓD.	PÁG.	€		EAN
20100	57	10,70	45	8437012168046
20101	57	11,70	27	8437012168701
20200	60	10,95	50	8437012168053
20201	60	12,05	27	8437012168718
20203	60	11,45	50	8436613910429
20300	62	6,00	65	8437012168084
20301	62	6,25	60	8437012168091
20400	63	8,40	55	8437012168114
20401	63	8,70	45	8437012168138
20600	61	10,40	40	8437012762107
20601	61	11,40	24	8437012762114
20603	61	10,90	24	8436590212837
20800	58	10,40	35	8437012762732
20801	58	11,40	20	8437012762794
20803	58	10,90	35	8436590212875
21100	55	13,85	45	8437012762084
21101	55	14,85	27	8437012762077
21101.1	55	14,85	100	
21103	55	14,35	45	8436590216590
21300	56	12,95	35	8437012763036
21301	56	13,95	21	8437012763043
21301.1	56	13,95	84	
21303	56	13,45	35	8436613910412
21400	59	13,80	50	8437012764323
21401	59	14,80	24	8437012764514
21600	54	14,95	45	8437012764798
21601	54	15,95	27	8437012764866
21601.1	54	15,95	100	
22010	39	16,30	20	8437012168206
22011	39	14,00	25	8437012168220
22014	39	20,10	20	8437012760097
25010	42	10,70	22	8436590219652
27012	41	6,15	45	8437012168503
27013	41	4,60	50	8437012168275
28001	82	5,75	60	8437012168527
28002	82	6,30	50	8437012168541
28003	82	9,80	40	8437012168558
28100	82	14,45	30	8437012168350
28101	82	16,50	25	8437012168381
30000	106	1,80	25	8437012760349

CÓD.	PÁG.	€		EAN
30001	106	2,05	25	8437012760356
30002	106	1,30	25	8437012760363
30003	106	2,30	25	8437012760370
30004	106	1,65	25	8437012760387
30005	106	2,40	25	8437012760394
30006	107	0,80	25	8437012760400
30007	107	1,75	25	8437012762664
30009	107	1,60	25	8437012765283
30010	107	1,15	25	8437012765290
30011	95	3,75	_	8436590216217
30015	106	3,30	25	8436590219164
30050	104	1,85	10	8437012760417
30051	104	3,95	10	8437012760424
30052	104	2,65	10	8437012760431
30053	104	1,60	10	8437012760448
30100	105	0,65	50	8437012760455
30101	104	1,50	25	8437012760462
30102	104	1,00	25	8437012760479
30104	101	2,40	25	8437012760486
30109	101	1,25	25	8436590216415
30200	98	1,25	50	8437012760493
30201	102	1,65	10	8437012760509
30202	102	0,80	25	8437012760516
30204	102	1,00	10	8437012760523
30207	103	1,15	50	8437012760554
30208	99	1,15	25	8437012760561
30209	99	1,05	25	8437012760578
30210	98	1,10	100	8437012760585
30211	98	1,10	100	8437012760592
30212	98	1,10	50	8437012760608
30213	100	2,05	50	8437012760615
30214	100	1,75	50	8437012760622
30215	103	0,60	50	8437012760639
30216	99	1,85	25	8437012760646
30218	98	1,00	100	8437012760660
30219	100	1,90	50	8437012760677
30220	100	1,80	50	8437012760684
30221	101	1,55	25	8437012760691
30222	100	1,55	50	8437012760707
30223	98	1,20	50	8437012760714

CÓD.	PÁG.	€		EAN
30226	101	2,80	25	8437012760745
30230	102	1,65	10	8437012763456
30231	99	1,50	50	8437012765221
30300	108	5,50	10	8437012760776
30304	110	2,55	10	8437012760814
30305	110	3,45	25	8437012760820
30306	110	3,30	25	8437012760837
30308	110	5,95	25	8437012760851
30309	110	5,95	25	8437012760868
30310	109	3,70	25	8437012762169
30310.NE	109	4,10	25	8436590218013
30314	109	3,70	25	8437012763159
30314.NE	109	4,10	25	8436590218020
30315	109	3,15	25	8437012765344
30317	108	4,10	10	8437012763463
30319	109	1,30	25	8437012763470
30319.NE	109	1,40	25	8436590219171
30321	109	3,05	25	8437012765337
30323	108	17,33	5	8437012765320
30325	108	6,85	10	8437012765313
30330	21	33,10	_	8437012763487
30331	21	45,15	_	8437012763494
30332	21	45,15	_	8437012763500
30333	21	172,20	_	8437012763517
30340	20	40,80	_	8436590215708
30341	20	40,80	_	8436590215715
30342	20	47,40	_	8436590215692
30343	20	47,40	_	8436590215722
30350	18	25,90	_	8436590217023
30351	18	35,90	_	8436590217030
30352	18	39,90	_	8436590217047
30354	18	33,50	_	8436590217023
30355	18	35,90	_	8436590217320
30356	18	33,50	_	8436590217337
30357.10	18	40,70	_	8436613910375
30360	18	25,90	_	8436590217030
30361	18	35,90	_	8436590217047
30362	18	39,90	_	8436590217092
30364	18	33,50	_	8436590217115
30365	18	35,90	_	8436590217344

ÍNDICE POR CÓDIGO

CÓD.	PÁG.	€		EAN
30366	18	33,50	—	8436590217351
30370	18	25,90	—	8436590217122
30371	18	35,90	—	8436590217139
30372	18	39,90	—	8436590217146
30374	18	33,50	—	8436590217160
30375	18	35,90	—	8436590217368
30376	18	33,50	—	8436590217375
30400	105	1,55	50	8437012760875
30402	103	8,70	20	8437012760899
30403	111	15,65	—	8437012763524
30404	111	10,40	—	8437012763531
30405	111	11,50	—	8437012763548
30406	111	8,30	—	8437012763555
30407	111	15,50	—	8437012763562
30408	111	19,50	—	8436590216224
30409	111	20,90	—	8436590216231
30410	111	20,90	—	8436590216248
30412	21	19,45	—	8437012765481
30413	21	19,45	—	8437012765498
30416	128	0,60	50	8436590216255
30417	128	0,75	50	8436590216262
30418	128	0,55	50	8436590216279
30419	128	2,90	50	8436590216286
30423	20	14,20	—	8436590216293
30425	72	5,90	—	8436590219669
30426	72	8,10	—	8436590219676
30427	72	8,20	—	8436590219690
30431	99	3,30	25	8436590215241
30432	99	3,90	25	8436590215258
30433	20	17,15	—	8436590216309
30436	20	14,60	—	8436590216316
30459	72	4,50	—	8436590219720
30460	73	7,40	—	8436590219737
30460.NE	73	8,40	—	8436590219744
30461	73	13,80	—	8436590219751
30461.NE	73	15,90	—	8436590219768
30462	73	7,40	—	8436590219775
30463	72	15,30	—	8436590219706
30480	19	13,50	—	8436590217801
30481	19	12,50	—	8436590217818

CÓD.	PÁG.	€		EAN
30482	19	7,20	—	8436590217825
30483	19	8,60	—	8436590217849
30484	19	9,70	—	8436590217832
30485	19	7,95	—	8436590217856
30486	19	7,35	—	8436590217863
30487	19	7,85	—	8436590217870
30488	19	2,95	—	8436590217887
30489	19	3,85	—	8436590217894
30490	19	3,95	—	8436590217900
30491	19	5,95	—	8436590217917
30492	19	7,95	—	8436590217924
30493	19	4,75	—	8436590217931
30494	19	4,75	—	8436590217948
30495	19	4,75	—	8436590217955
30497	19	6,55	—	8436613910399
30498	19	6,55	—	8436613910405
30499	19	4,75	—	8436613910382
30500	94	4,55	36	8437012760905
30501	94	4,30	36	8437012760912
30502	94	4,55	36	8437012760929
30503	94	4,30	36	8437012760936
30504	95	5,60	36	8437012760943
30505	95	5,20	36	8437012760950
30506	95	5,60	36	8437012760967
30507	95	5,20	36	8437012760974
30508	93	3,65	30	8437012760110
30509	93	3,65	30	8437012760127
30510	92	13,90	10	8437012760981
30511	93	15,50	15	8437012760998
30512	93	5,45	22	8437012760066
30513	92	18,95	10	8437012762695
30514	92	12,90	10	8437012763579
30521	93	14,45	18	8437012764637
30522	92	18,75	10	8437012764644
30523	92	13,50	10	8437012764897
30524	93	14,90	15	8437012764903
30526	92	31,50	—	8436590219133
30527	93	15,50	15	8436613910443
30600	118	34,25	—	8437012761001
30600.BLM	124	63,90	—	8437012766143

CÓD.	PÁG.	€		EAN
30600.BRV	125	55,50	—	8437012766082
30600.CO	124	55,50	—	8437012765917
30600.NE	124	63,90	—	8437012765870
30600.NI	125	55,50	—	8437012765887
30600.ORO	125	55,50	—	8437012766075
30600.Z	118	29,90	—	8436590216385
30602	118	20,95	—	8437012761018
30602.Z	118	17,95	—	8436590216392
30603	152	2,95	50	8437012760004
30604	152	3,00	50	8437012760011
30605	152	6,85	50	8437012760028
30606	152	6,85	50	8437012760035
30607	116	12,95	50	8437012761025
30608	116	13,95	50	8437012761032
30609	152	3,35	50	8437012760042
30610	152	3,30	50	8437012760059
30611	115	13,20	50	8437012762176
30611.BLM	122	23,90	50	8437012766150
30611.BRV	123	22,50	50	8437012766105
30611.CO	122	22,50	50	8437012765931
30611.NE	122	23,90	50	8437012765924
30611.NI	123	22,50	50	8437012765948
30611.ORO	123	22,50	50	8437012766099
30612	117	15,75	50	8437012762183
30613	161	1,70	10	8437012763586
30614	157	0,95	10	8437012765443
30615	157	0,95	10	8437013765450
30616	107	3,30	25	8437012765306
30617	105	1,05	50	8437012765238
30618	105	1,05	50	8437012765245
30619	105	1,00	50	8437012765252
30620	105	1,00	50	8437012765269
30621	105	2,20	50	8437012765276
30622	118	45,15	—	8437012764521
30624	115	10,45	50	8437012764545
30625	117	16,80	50	8437012764552
30628	157	0,95	10	8436590216323
30629	128	5,20	50	8436590216330
30629.BLM	128	6,40	50	8436590219355
30629.BRV	128	6,40	50	8436590219348

CÓD.	PÁG.	€		EAN
30629.CO	128	6,40	50	8436590219362
30629.NE	128	8,50	50	8436590216347
30629.NI	128	6,40	50	8436590219386
30629.ORO	128	6,40	50	8436590219379
30634	153	4,60	50	8436590216439
30635	159	1,10	25	8436590216422
30636	119	66,90	—	8436590217269
30637	153	4,20	50	8436590218037
30638	153	4,25	50	8436613910306
30641	154	0,70	50	8436613910450
30642	154	0,70	50	8436613910467
30643	154	1,45	50	8436613910474
30644	154	1,45	50	8436613910481
30645	154	0,45	50	8436613910498
30646	154	0,45	50	8436613910504
30700	87	14,90	12	8437012761049
30701	84	31,90	9	8437012764101
30701.1	84	31,90	18	
30702	84	35,90	9	8437012764118
30702.1	84	35,90	18	
30703	85	40,90	10	8437012764125
30703.1	85	40,90	20	
30705	88	3,30	—	8437012764132
30706	88	13,80	—	8437012764149
30707	88	2,10	—	8437012764156
30708	88	2,10	—	8437012764163
30709	85	55,90	9	8437012765207
30709.1	85	55,90	18	
30710	86	46,95	9	8437012765214
30710.1	86	46,95	18	
30711	86	45,90	9	8437012764934
30711.1	86	45,90	18	
30715	87	68,15	5	8436590215920
30716	87	82,50	2	8436590215937
30717	90	52,70	5	8436590215944
30718	90	96,50	5	8436590215951
30719	88	12,70	—	8436590216354
30720	88	12,70	—	8436590216361
40000	80	27,95	12	8437012168756
40001	80	17,75	12	8437012761056

CÓD.	PÁG.	€		EAN
40002	80	17,75	12	8437012761063
40100	76	63,95	5	8437012761094
40101	76	66,95	5	8437012761100
40102	76	68,95	5	8437012761117
40103	78	52,40	5	8437012764712
40104	78	48,20	5	8437012764804
40220	14	259,00	—	8436590217177
40230	15	229,00	—	8436590218242
40240	16	178,00	—	8436590218419
40320	17	142,00	—	8436590218051
40400	27	380,00	—	8437012765177
40410	27	395,00	—	8437012765160
40420	25	378,00	—	8437012765153
40430	25	378,00	—	8437012765146
40500	30	108,90	—	8437012765184
40510	30	141,75	—	8437012765191
51010	33	16,50	25	8437012761933
51010.1	33	16,50	60	
51011	33	14,90	32	8437012761940
51012	33	17,85	16	8437012761926
51012.1	33	17,85	48	
51014	33	19,80	25	8437012761957
51015	33	21,15	16	8437012761971
51021	33	16,30	16	8437012762435
51100	51	26,50	16	8437012762190
51200	51	26,75	16	8437012762206
51300	51	21,80	16	8437012762213
51400	51	24,25	16	8437012762220
51714	52	30,90	15	8437012762718
51715	52	32,20	10	8436590217566
53010	35	20,10	25	8437012763203
53010.1	35	20,10	55	
53011	35	17,95	32	8437012763234
53012	35	21,60	16	8437012763210
53012.1	35	21,60	48	
53014	35	23,10	25	8437012763258
53015	35	24,25	16	8437012763265
53021	35	19,35	16	8437012763241
53100	50	32,00	15	8437012763609
53200	50	32,30	16	8437012763616

CÓD.	PÁG.	€		EAN
53300	50	27,25	16	8437012763623
53400	50	29,75	15	8437012763630
53714	52	34,20	15	8437012763647
53715	52	35,90	10	8436590217573
54000	40	15,40	22	8437012764910
54004	40	18,35	22	8437012764927
56010	37	20,70	14	8437012764231
56011	37	18,70	18	8437012764248
56012	37	22,00	12	8437012764330
56014	37	23,50	14	8437012764255
56015	37	24,85	12	8437012764354
56021	37	20,00	12	8437012764347
70021	71	9,40	—	8437012763005
70030	71	7,10	—	8437012763654
70060	71	17,35	—	8437012764309
70070	71	15,25	—	8437012765139
70071.NE	68	79,75	—	8436613910436
70072	69	41,95	—	8437012764972
70074	69	28,10	—	8437012764958
70076	69	39,80	—	8437012764965
70077	66	83,75	—	8437012766044
70077.NE	67	109,00	—	8437012766297
70078	66	129,25	—	8437012766051
70078.ECO	68	129,25	—	8437012766280
70078.NE	67	158,95	—	8437012766273
70082	70	37,50	—	8437012765092
70084	70	20,90	—	8436590213940
70084	70	20,90	—	8437012765078
70086	70	35,60	—	8437012765085
660271	160	1,35	25	8437012761162
660301	160	1,15	25	8437012761193
660305	159	0,70	25	8437012761209
660306	161	0,90	10	8437012761216
660309	161	0,70	10	8437012761223
660310	158	0,40	50	8437012761230
660311	158	0,40	50	8437012761247
660312	159	0,40	25	8437012761254
660313	161	0,80	10	8437012761261
660314	158	0,50	50	8437012761278
660315	158	0,45	25	8437012761285

ÍNDICE POR CÓDIGO

CÓD.	PÁG.	€		EAN
660316	161	0,75	10	8437012761292
660318	159	0,40	25	8437012761308
660320	158	0,40	50	8437012761315
660322	159	0,40	25	8437012761322
660323	161	0,75	10	8437012761339
660325	159	0,40	25	8437012761346
660326	161	1,10	10	8437012761353
660331	159	0,40	25	8437012761360
660332	158	0,50	50	8437012761377
660333	161	1,00	10	8437012761384
660334	158	0,45	50	8437012761391
660335	159	1,20	25	8436613910528
660336	159	0,80	25	8436613910511
660337	160	0,70	25	8437012761407
660338	161	1,20	10	8437012761414
660339	158	0,60	50	8437012761421
660340	159	0,65	25	8437012761438
660344	158	0,40	50	8437012761445
660346	161	0,65	10	8437012761452
660363	161	1,15	10	8436590210482
660364	161	0,80	10	8437012761483
660365	161	0,80	10	8437012761490
660370	161	1,10	10	8437012761506
660373	161	1,60	10	8437012761537
660380	159	1,05	10	8437012761544
660381	161	0,80	10	8437012761551
660396	159	0,90	10	8437012761575
660401	130	6,10	50	8437012168015
660402	130	4,05	80	8437012168022
660403	130	6,10	65	8437012168039
660403.E	130	6,70	60	8436590216095
660404	130	6,85	45	8437012760073
660405	131	6,85	40	8437012168602
660406	131	6,85	35	8437012168060
660407	131	7,35	30	8437012168077
660410	134	3,55	60	8437012168107
660410.E	134	4,25	60	8436590216101
660411	135	4,95	45	8437012168619
660411.E	135	5,95	45	8436590216118
660412	135	5,95	45	8437012168121

CÓD.	PÁG.	€		EAN
660413	135	4,70	40	8437012761599
660414	135	6,10	35	8437012761605
660419	136	4,40	50	8437012168916
660420	136	4,25	50	8437012761612
660420.E	136	4,95	45	8436590216125
660421	136	4,55	40	8437012168213
660421.E	136	5,15	40	8436590216132
660422	136	5,45	35	8437012168626
660425	137	9,80	15	8437012168251
660426	137	12,35	14	8437012168268
660427	137	10,55	14	8437012168831
660428	137	13,25	12	8437012168282
660429	138	10,35	15	8437012168299
660430	138	11,45	12	8437012168305
660430.E	138	12,70	12	8436590216149
660435	132	3,50	65	8437012760141
660435.E	132	4,45	65	8436590216156
660436	132	3,50	65	8437012168367
660436.E	132	4,65	65	8436590216163
660437	139	3,25	65	8437012168374
660437.E	139	3,90	65	8436590216170
660438	139	4,05	50	8437012761650
660439	139	4,15	50	8437012168398
660440	138	8,20	40	8437012168404
660445	148	9,20	30	8437012168459
660446	148	8,70	35	8437012168466
660449	148	8,75	40	8437012168947
660455	148	9,80	40	8437012761704
660456	148	9,90	25	8437012761711
660462	136	4,40	50	8437012763074
660463	162	2,00	1	8437012168633
660465	143	4,05	50	8437012168657
660466	143	4,10	75	8437012168664
660468	143	4,60	75	8437012168688
660469	143	4,95	75	8437012168695
660470	144	6,20	60	8437012168978
660471	144	11,45	24	8437012168824
660474	163	2,40	1	8437012761735
660475	163	2,60	1	8437012761742
660476	162	1,80	1	8437012168763

CÓD.	PÁG.	€		EAN
660477	162	1,80	1	8437012761759
660480	163	1,50	1	8437012168855
660481	163	1,85	1	8437012168879
660482	163	3,35	1	8437012168909
660483	162	2,10	1	8437012761766
660484	157	1,65	10	8437012168961
660485	162	2,20	1	8437012168848
660486	162	2,05	1	8437012168862
660487	164	4,00	1	8437012761773
660488	164	4,25	1	8437012168886
660489	160	2,00	25	8437012761780
660490	160	1,75	25	8437012761797
660491	160	2,20	10	8437012765467
660493	164	1,30	1	8437012761810
660494	164	1,60	1	8437012761827
660495	164	3,85	1	8437012761834
660496	162	2,25	1	8437012761841
660497	162	2,35	1	8437012761858
660498	162	2,00	1	8437012168985
660499	162	2,15	1	8437012168992
660500	157	2,20	10	8437012763661
660501	157	2,75	10	8437012763678
660502	156	4,65	10	8437012762336
660503	156	3,35	10	8437012762343
660504	156	3,40	10	8437012762350
660505	156	3,40	10	8437012762367
660507	144	10,40	30	8437012762381
660508	162	1,80	1	8437012762398
660512	142	16,80	32	8437012763081
660513	142	18,65	17	8437012762862
660514	142	18,65	25	8437012762879
660515	142	20,30	15	8437012762886
660516	157	2,80	10	8437012763685
660518	131	3,60	50	8437012765351
660519	164	1,60	1	8437012765474
660520	132	4,30	85	8437012765368
660521	132	4,35	85	8437012765375
660523	132	3,95	75	8437012765382
660524	132	4,60	85	8437012765399
660525	132	4,00	75	8437012765405



ÍNDICE POR CÓDIGO

CÓD.	PÁG.	€		EAN
660526	132	4,65	85	8437012765412
661151	143	6,00	50	8437012168473
661152	143	5,60	55	8437012168480
661154	145	11,75	40	8437012764651
661155	145	10,90	45	8437012764668
661156	145	13,30	30	8437012764675
661157	145	10,90	45	8437012764682
661158	144	6,50	75	8437012765429
661159	144	10,90	36	8437012765436
661161	150	13,85	35	8437012168954
661162	150	13,85	30	8437012761865
661164	134	12,45	65	8437012762893
661165	134	16,75	30	8437012762909
661181	138	7,75	22	8437012761872